

Cleco®

**Durable.
Economical.
Low Maintenance.**

Unbeatable Performance

We are constantly improving our products to guarantee you ideal productivity. The new Cleco H-Series pulse tools combine legendary durability with unmatched repeatability so that you will be able to complete every joint quickly and reliably.

■ **Broad Tool Selection**

With a variety of shut-off and non-shut-off pulse tools to choose from you are sure to find just the right Cleco pulse tool for the job.



High Precision Shut-Off

mechanism ranges close to the characteristics of an electric tool at a tolerance of +/- 10% at Six Sigma.

Efficient 3-Chamber Air Motor

- Speed governor
- Reduces your tightening time with increased torque and a usable high-end dynamic.
- Unique design reduces blade wear.
- Less vibration for increased user comfort
- Reduced air consumption



3-Chamber Motor Housing

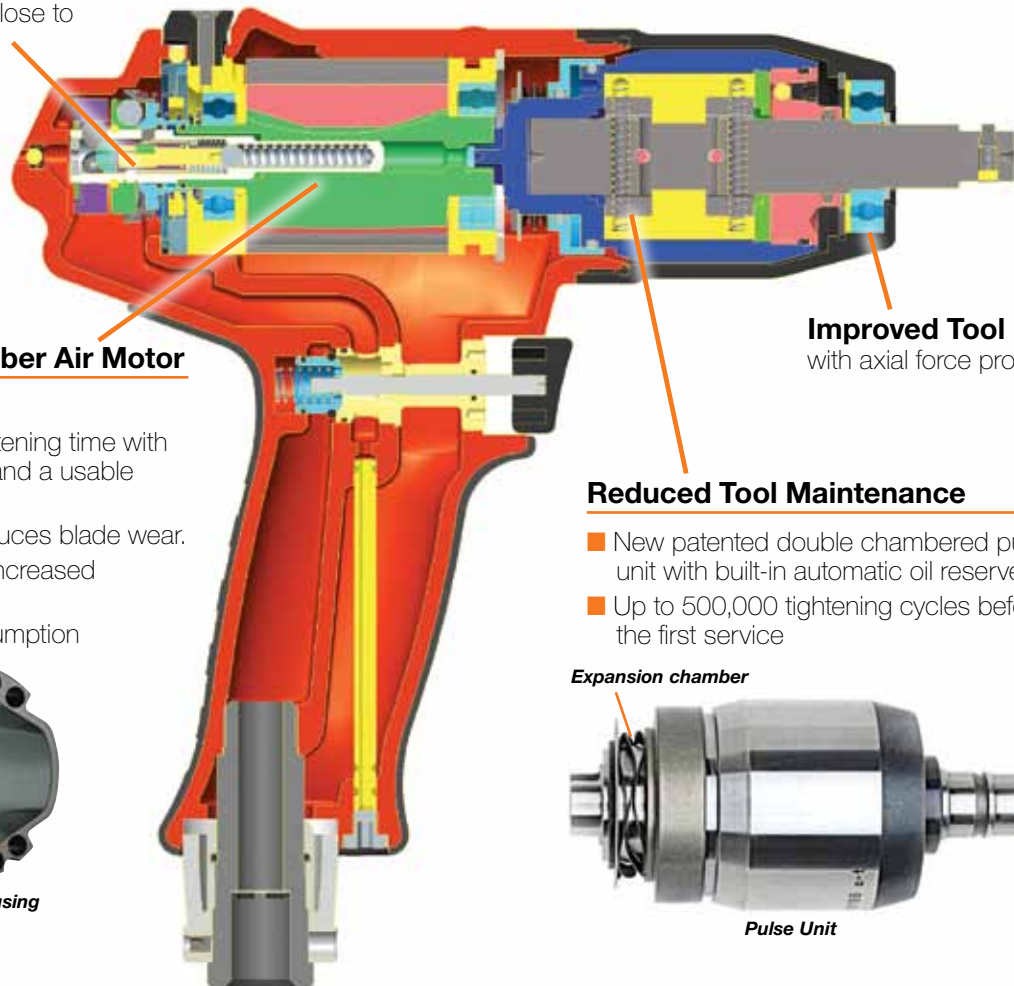

Improved Tool End
with axial force protection

Reduced Tool Maintenance

- New patented double chambered pulse unit with built-in automatic oil reserve
- Up to 500,000 tightening cycles before the first service

Expansion chamber



Pulse Unit

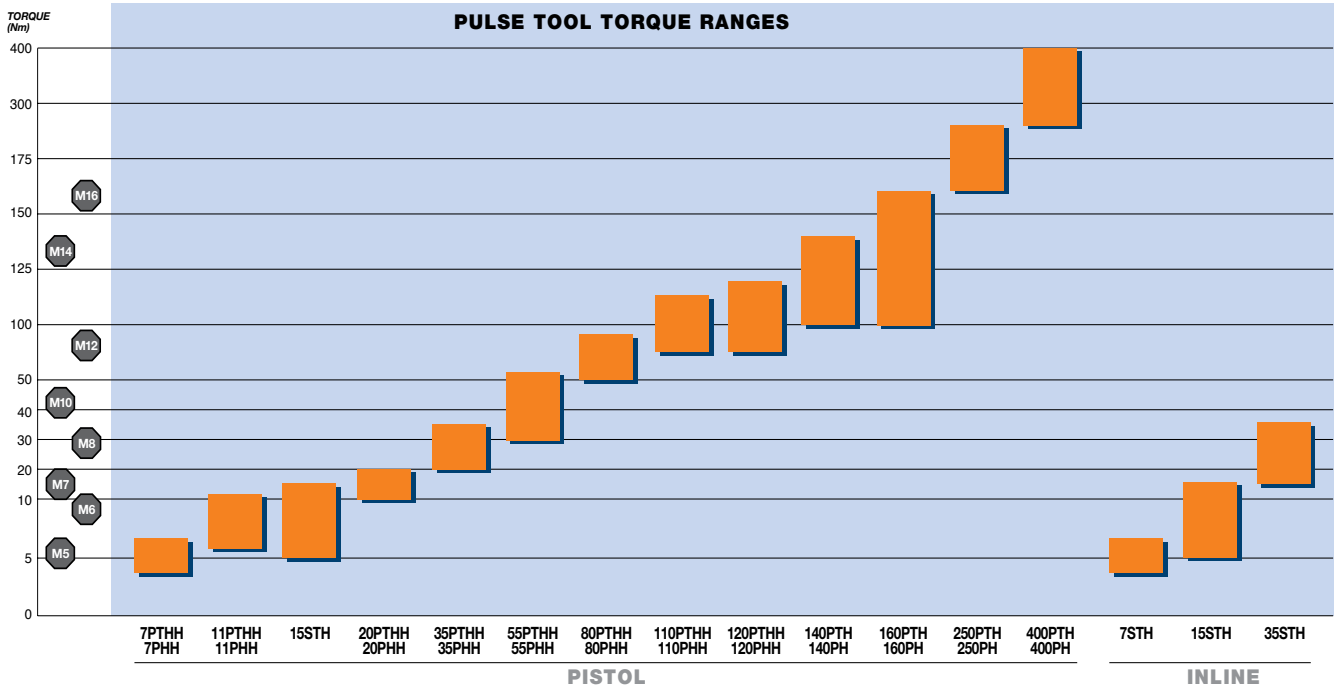

Low Noise Levels

Noise levels of these tools are well below standard air tools for an operator-friendly environment. There is no loud metallic hammering under load.

Ships Ready For Error Proofing

- Works with existing TVP torque verifier
- Located near air inlet to maximize ergonomics



Easy Set-Up

- Insert 2mm hex into rear port of tool
- Positive stops in both directions to prevent loss and/or damage



Adjustable Motor Speed

- Easily adjustable motor speed to insure accuracy on hard joints
- Can be locked in place to prevent accidental adjustment



Pulse Nutrunners

Hydraulic Pulse Shut-Off & Non Shut-Off



H-Series PTH

Torque Range: 4 - 120 Nm
3.0 - 88.8 Ft. Lbs
Bolt Size: M5 - M12
#10 - 1/2"

- Inertia shut-off
- Motor governor equipped
- External torque adjustment
- External speed control
- Torque signal port
- Adjustable pulse unit volume simplifies maintenance
- Market-leading repeatability
- Reversible
- Oilless blades 



C-Series PTHC & PTHFC

Torque Range: 100 - 400 Nm
74 - 295 Ft. Lbs
Bolt Size: M12 - M20
1/2" - 3/4"

- Hydraulic pulse shut-off
- Motor governor equipped
- External torque adjustment
- External speed control
- Reversible
- Oilless blades 
- Torque signal port



C-Series STHFC & STHF

Torque Range: 2.6 - 35 Nm
1.9 - 26 Ft. Lbs
Bolt Size: M5 - M8
#10 - 3/8"

- Hydraulic pulse shut-off
- Motor governor equipped
- External torque adjustment
- External speed control
- Reversible
- Oilless blades 
- Torque signal port



Model Number Nomenclature

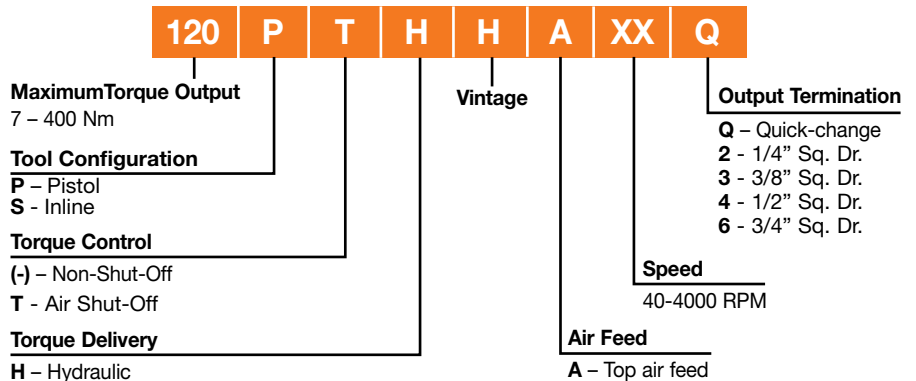

	Model Number	Drive Type	Torque Range		Free Speed	Weight		Air Consumption			
			Ft.Lbs.	Nm	RPM	lbs.	kg	NPT	Hose I.D.	SCFM	
S H U T O F	H-Series – Pistol Grip – Shut-Off Models										
	7PTHH352	1/4" Sq.Dr.	3.0-5.1	4-7	3500	1.74	0.79	1/4"	3/8"	7.06	
	7PTHH35Q	1/4" QC	3.0-5.1	4-7	3500	1.74	0.79	1/4"	3/8"	7.06	
	11PTHH352	1/4" Sq.Dr.	4.4-8.1	6-11	3500	1.81	0.82	1/4"	3/8"	7.06	
	11PTHH35Q	1/4" QC	4.4-8.1	6-11	3500	1.87	0.85	1/4"	3/8"	7.06	
	11PTHH353*	3/8" Sq.Dr.	4.4-8.1	6-11	3500	1.83	0.83	1/4"	3/8"	7.06	
	20PTHH40Q	1/4" QC	7.4-14.7	10-20	4000	1.92	0.87	1/4"	1/2"	8.7	
	20PTHH403*	3/8" Sq.Dr.	7.4-14.7	10-20	4000	1.90	0.86	1/4"	1/2"	8.7	
	35PTHH40Q	1/4" QC	14.8-25.8	20-35	4000	2.31	1.05	1/4"	1/2"	15.9	
	35PTHH403*	3/8" Sq.Dr.	14.8-25.8	20-35	4000	2.31	1.05	1/4"	3/8"	15.9	
	55PTHH403*	3/8" Sq.Dr.	22.1-40.5	30-55	4000	2.54	1.15	1/4"	3/8"	15.9	
	80PTHH35Q	7/16" QC	36.9-59.0	50-80	3500	3.20	1.45	1/4"	3/8"	19.4	
80PTHH354	1/2" Sq.Dr.	36.9-59.0	50-80	3500	3.10	1.40	1/4"	3/8"	19.4		
110PTHH30Q	7/16" QC	55.3-81.1	75-110	3000	3.75	1.70	3/8"	1/2"	19.4		
120PTHH304	1/2" Sq.Dr.	55.3-88.8	75-120	3000	3.75	1.70	3/8"	1/2"	19.4		
O F	C-Series – Pistol Grip – Shut-Off Models										
	140PTHFC25Q	7/16" QC	74-103	100-140	2500	5.7	2.6	3/8"	1/2"	25.4	
160PTHFC256	3/4" Sq.Dr.	74-118	100-160	2500	5.7	2.6	3/8"	1/2"	25.4		
F	C-Series – Pistol Grip – Shut-Off Models – Trigger Throttle										
	250PTHFC226	3/4" Sq.Dr.	118-184	160-250	2200	8.8	4.0	3/8"	1/2"	33.5	
400PTHFC206	3/4" Sq.Dr.	185-295	250-400	2000	11.7	5.3	3/8"	1/2"	33.5		
S H U T O F	In-Line – Push-to-Start										
	7STHFA55Q	1/4" QC	1.9-4.9	2.6-6.6	5500	1.8	0.83	1/8"		7.0	
	35STHFA40Q	7/16" QC	12-26	15-35	4000	3.1	1.4	1/4"	3/8"	15.9	
	35STHFA404	1/2" Sq.Dr.	12-26	15-35	4000	2.9	1.3	1/4"	3/8"	15.9	
S H U T O F	C-Series – In-Line – Lever										
	7STHFC55Q	1/4" QC	1.9-4.9	2.6-6.6	5500	2.1	0.93	1/8"		7.0	
	15STHFC40Q	1/4" QC	3.6-11	5.0-15	4000	2.4	1.1	1/4"	3/8"	16.5	
	35STHFC40Q	7/16" QC	12-26	15-35	4000	3.3	1.5	1/4"	3/8"	15.9	
	35STHFC404	1/2" Sq.Dr.	12-26	15-35	4000	3.3	1.5	1/4"	3/8"	15.9	
15STHC40Q	1/4" QC	3.6-11	5.0-15	3000	2.4	1.1	1/4"	3/8"	16.5		

PTHHA=Top Air Inlet

(*) 7/16" Quick Change Chuck available separately as an accessory

General:

Tool performance rated @ 87 psi (6 bar) air pressure.

Standard Equipment:

Suspension bail and torque adjusting wrench.
Torque signal port (pistol grip models only)

Optional Equipment:

Additional accessories: Page 53



Pulse Nutrunners

Hydraulic Pulse Non Shut-Off

Cleco®

H-Series PH Non-Shut-Off

Torque Range: 4 - 120 Nm
2.9 - 88.5 Ft. Lbs

Bolt Size: M5 - M12
#10 - 1/2"

- External speed control
- Reversible
- Oilless blades 



	Model Number	Drive Type	Torque Range		Free Speed RPM	Weight		Air Consumption		
			Ft.Lbs.	Nm		lbs.	kg	NPT	Hose I.D.	SCFM
NON SHUT OFF	H-Series – Pistol Grip – Non Shut-Off Models									
	7PHH602	1/4" Sq.Dr.	2.9-5.2	4-7	6000	1.70	0.77	1/4"	3/8"	8.7
	7PHH60Q	1/4" QC	2.9-5.2	4-7	6000	1.74	0.79	1/4"	3/8"	8.7
	11PHH653*	3/8" Sq.Dr.	4.4-8.1	6-11	6500	1.74	0.79	1/4"	3/8"	10.5
	11PHH652	1/4" Sq.Dr.	4.4-8.1	6-11	6500	1.72	0.78	1/4"	3/8"	10.5
	11PHH65Q	1/4" QC	4.4-8.1	6-11	6500	1.76	0.80	1/4"	3/8"	10.5
	20PHH753*	3/8" Sq.Dr.	7.4-14.7	10-20	7500	1.85	0.84	1/4"	3/8"	17.3
	20PHH75Q	1/4" QC	7.4-14.7	10-20	7500	1.90	0.86	1/4"	3/8"	17.3
	35PHH653*	3/8" Sq.Dr.	14.7-25.8	20-35	6500	2.25	1.02	1/4"	3/8"	19.4
	35PHH65Q	1/4" QC	14.7-25.8	20-35	6500	2.29	1.03	1/4"	3/8"	15.9
	55PHH603*	3/8" Sq.Dr.	22.1-40.5	30-55	6000	2.47	1.12	1/4"	3/8"	22.9
	80PHH604	1/2" Sq.Dr.	36.9-59.0	50-80	6000	3.09	1.40	1/4"	3/8"	26.5
80PHH60Q	7/16" QC	36.9-59.0	50-80	6000	3.13	1.41	1/4"	3/8"	26.5	
110PHH55Q	7/16" QC	55.3-81.1	75-110	5500	3.68	1.66	3/8"	1/2"	30.0	
120PHH554	1/2" Sq.Dr.	55.3-88.5	75-120	5500	3.64	1.65	3/8"	1/2"	30.0	
OFF	High Torque Pistol Grip – Non-Shut-Off Models									
	140PH45Q	7/16" QC	74-103	100-140	4500	5.7	2.6	3/8"	1/2"	31.7
	160PH456	3/4" Sq.Dr.	74-118	100-160	4500	5.7	2.6	3/8"	1/2"	31.7
	250PHF406	3/4" Sq.Dr.	118-184	160-250	4000	8.6	3.9	3/8"	1/2"	40.6
	400PHF356	3/4" Sq.Dr.	184-295	250-400	3500	11.5	5.2	3/8"	1/2"	42.3

PTHHA=Top Air Inlet

(*) 7/16" Quick Change Chuck available separately as an accessory.

For 7-75 Series Models, small handle can be ordered by substituting "S" for "L" in model number.

General:

Tool performance rated @ 87 psi (6 bar) air pressure.

Standard Equipment:

Suspension bail and torque adjusting wrench.

Optional Equipment:

Additional accessories: Page 53

Rubber Tool Stand



Part Number	Tool Series
931041 (one piece)	D & H Series 7PTH – 120PTH
930119 (two pieces)	C Series 140/160PTH/PH/ 250PTH / 400PTH

TVP-100 Torque Signal Kit

Air signal to indicate shut-off.

Part Number	Tool Series
934918	PTH series pulse tools and vintage shut-off tools only

7/16" Quick Change Chuck Adapter

Part Number	Tool Series
935472	To convert 11/20/35/55PTHH/PTHHA/ PHH/PHHA to a Quick-Change chuck



Vibration Absorber

Part No.	Fits Model
935965	35/55PTHHA/PHHA
935966	80/110/120PTHHA/PHHA



Hydraulic Filler Unit

Part Number			Tool Series
Filler Unit Complete	Filler Unit Only	Connector Only	
928477		932072	140/160 PTHC../ PH..
928473	928483	928485	250/400 PTHC../ PH..
928475			35 STH..
928474		931663	7 STH..
		928486	15 STH..



928483 Filler Unit

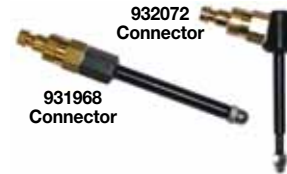

932072 Connector

931968 Connector

Reserve Oil Filling Set

Part No.
936695PT



Hydraulic Oil

Part Number	Container Size
539317	One Quart



Covers

Part No.	Fits Model
937442PT	Protective cover for 7/11/20PTHHA/7/11/20PHHA
937443PT	Protective cover for 35PTHHA/35PHHA
937444PT	Protective cover for 55PTHHA/55PHHA
937445PT	Protective cover for 80PTHHA/80PHHA
937446PT	Protective cover for 110/120PTHHA/110/120PHHA
937447PT	Protective cover for 7/11/20PTHH/7/11/20PHH
937448PT	Protective cover for 35PTHH/35PHH
937449PT	Protective cover for 55PTHH/55PHH
937450PT	Protective cover for 80PTHH/80PHH
937451PT	Protective cover for 110/120PTHH/110/120PHH

