

SERENCO

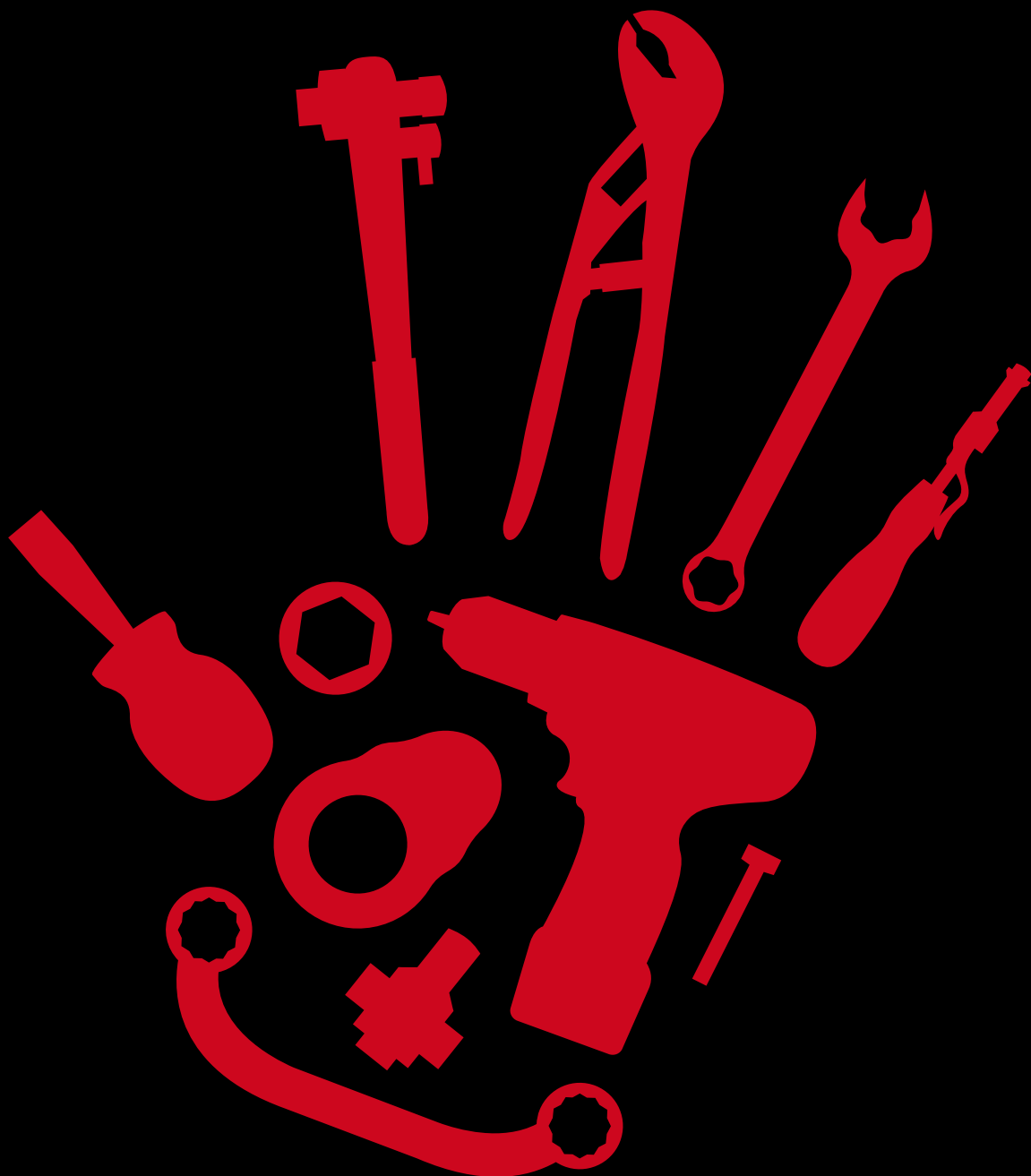

serious tools > serious results



PRODUCT CATALOGUE



WE ARE PROUD DISTRIBUTER OF



Power-Start is manufactured in the UK and designed specifically for the professional user, the Power-Start high rate jump start pack is suitable for starting most 12 V and 24 V engines – automotive, air, marine and rail. With safety in mind, each starter pack incorporates many safety features. Reverse polarity warning reduces the risk of wrongful connection whilst spike protection circuits reduce the risk of damage to the vehicle on-board electronic systems. The on/off isolator switch ensures a safe connection due to nonOlive cable clamps and also avoids unintentional short circuit. Manufactured by a company with NATO certification, it's not surprising that Power-Start is the professionals choice.



Our own range of Powerhand power tools are a well-established, high quality range of cordless Mini 10.8 V & 18 V Li-Ion tools. Our portfolio is mainly aimed at the automotive sector and includes a comprehensive range of impact wrenches, ratchets, caulking guns and more. All products are supplied with a 12 month warranty with full in-house after sales service. The range now, more than ever, lives up to its slogan 'Power for Professionals'.

Powerhand lights are well regarded as offering both high quality and excellent value. From pocket lights, to work lamps and specialist lighting such as under bonnet and flood lights, the Powerhand range is designed especially with both the workshop professional and roadside recovery operator in mind. All Powerhand lighting comes with a 12 month warranty.



Gojak was designed to improve vehicle movement and repositioning in workshops, showrooms and body shops but is also invaluable in car parks and to a multitude of rescue services. To overcome different axle widths, wheelbases, wheel sizes and tyre widths, every Gojak is self-loading. Gojak's are mechanical, therefore very quick and simple to use without the obvious hazard of leaking hydraulics. This system makes lifting and moving vehicles in any direction very quick and easy saving both time and money. With four models available an immense range of vehicles weighing up to 3.128 kg can be 'lifted & shifted'.



Boxo the name for quality tool storage systems developed for the professional automotive and industrial markets. Benefitting from over 40 years of experience in these industries manufacturing high quality tool storage systems. We focus on product research, design, durability, quality control with a real life testing facility. The creators of Boxo have developed this program of tool storage systems to suit all modern day requirements. Boxo continually works on product and service improvement. All Boxo products have been manufactured to meet or exceed international standards. 'Boxo, The choice for the professional! Satisfaction guaranteed!'

Our professional range of BOXO hand tools has continued to grow, and is a comprehensive hand tool offering. New products to this edition include additional ratchet and socket sets, multifix sockets, and a full range of individuals enabling the user to buy the most popular sizes or replace lost items without needing to replace an entire set. Most products in this range feature a limited lifetime warranty.

Our range contains impact solutions from 1/4" to 1", including sockets, socket bits, extension bars, adapters and universal joints for everyday workshop and industrial use.



This ingenious air operated tool opens up flexible CV boots effortlessly and evenly allowing simple insertion onto the shaft without the need to dismantle the joint. It totally eliminates the need for lubrication and the struggling involved with the manual cone method, saving you both time and money! The accompanying range of high quality, flexible neoprene rubber boots with resistance to ozone, oil, water, grit, abrasion and temperature extremes (-40° to 115°C) have been designed specifically for use with the Bootgun.



Our patented Metrinch wall drive profile drives only on the flats and not the corners, with specific calculations to enable a single Metrinch tool to be used on both metric and inch (AF, BSW & BSF) series fasteners. The specialist nature of Metrinch sockets and spanners make them ideal for use on worn and damaged bolts or even those completely rounded by abrasion.



RakJak is the preferred air jack for use on frame racks, alignment machines, for emergency road services and in a variety of repair shops. Every RakJak is compact, powerful, super-fast in use and virtually maintenance free. For additional safety and peace of mind every RakJak has a unique internal stabilizer that provides lateral and vertical stability. RakJak is simply the easiest and quickest way to lift any vehicle weighing up to 3 tons.



Eagle offers a comprehensive range of pneumatic tools for professional, daily use in automotive and industrial workshops. Featuring low vibration and noise qualities, composite handles and paddle style triggers on many of the units for improved user speed control. With a portfolio that includes Mini air tools, impact wrenches, ratchets, drills, die grinders, cutting, sanding and specialist tools there is a solution available for any busy workshop. New products in this issue include the extra-short 3/8" and 1/2" impact wrenches and low profile impact sockets and socket sets to enhance the usage of these tools. All products are supplied with a 12 month warranty with full in-house after sales service.



Tyre Seals repair kits have been specifically designed to enable puncture repairs whilst the wheel remains on the vehicle. With both string and mushroom type plug repair kits in the programme, Tyre Seals is a puncture repair system that is suitable for both passenger cars and trucks. Tyre Seals have a number of standard approvals but as on vehicle puncture repair regulations vary in different countries the user should always check the local regulations before use.

WHAT WE SUPPLY - CONTENTS:

POWER TOOLS 6 - 25

IMPACT WRENCHES / NEEDLE SCALERS / RATCHETS, DRILLS AND DRIVERS / RATCHETS / GREASE GUN / CAULKING GUNS / GRINDERS AND POLISHERS / BATTERIES / CHARGERS / SPARE PARTS

AIR TOOLS 26 - 61

AIR IMPACT WRENCHES / AIR RATCHETS / AIR DRILLS / AIR GRINDERS / AIR GRINDERS AND CUTTERS / AIR CUTTERS, SANDERS AND POLISHERS / AIR SANDERS / AIR TOOLS FOR THE SPECIALIST / ACCESSORIES AND SPARE PARTS / IMPACT SOCKETS / 3/8" IMPACT SOCKETS / 1/2" IMPACT SOCKETS / 3/4" IMPACT SOCKETS / 1" IMPACT SOCKETS

TOOL STORAGE 62 - 109

TOOL TROLLEYS / PARTS / ACCESSORIES / PARTS / TOP AND SIDE CHESTS / WORK BANCHES / OSM / DRAWER DIVIDERS / OSM / CARRY BOXES / PRE-CHOSEN TOOL-SYSTEM-MODULES

HAND TOOLS 110 - 197

TOOL-SYSTEM-MODULES / SOCKET SETS / SOCKET AND COMBINATION SETS / SOCKET RAIL SETS / RAILS / 1/4" SOCKETS / 3/8" SOCKETS / 3/8" AND 1/2" SOCKETS / 1/2" SOCKETS / 3/4" SOCKETS / ACCESSORIES / RATCHETS / TORQUE WRENCHES / WRENCHES / SCREWDRIVERS / HEX AND TX-KEYS / BIT SETS / PLIERS / HAMMERS / PLIERS / PUNCHES AND CHISELS / PRYBARS AND PICK TOOLS / CUTTING TOOLS / MEASURING TOOLS / VDE TOOLS / CAULKING GUNS

WORKSHOP EQUIPMENT 198 - 241

FLASH LIGHTS / HEAD LAMPS / PEN LIGHTS / WORK LAMPS / WORK LAMPS AND SPECIALIST LIGHTS / SPECIALIST LIGHTS/ ACCESSORIES / SOLDERING / INDUCTION / AIR JACKS / SELF LOADING DOLLIES / MATS AND SEAT COVERS / JUMP STARTERS / ACCESSORIES / BATTERY TOOLS / BATTERY CHARGERS / GENERAL WORKSHOP TOOLS

SPECIALIST VEHICLE TOOLS 242 - 296

BODYWORK AND INTERIOR TOOLS / WHEEL AND TYRE TOOLS / STEERING AND SUSPENSION TOOLS / ENGINE TOOLS / STEERING AND SUSPENSION TOOLS / BRAKE TOOLS / ENGINE TOOLS / PULLERS / OIL AND FUEL EQUIPMENT / TORQUE MULTIPLIERS / DIAGNOSTIC AND TESTING TOOLS

ABOUT US

Dear partner,

Serenco proudly brings time saving tools & equipment to the professional user in the automotive and industrial markets. Established since 1986 the company distributes with proprietary and/or exclusive brands on a global scale. Serenco's distribution network encompasses distributors, OE manufacturers and tool specialist in 46+ countries and continues to grow year on year.

Amongst other brands Serenco offers BOXO tools and storage equipment, GoJak vehicle movement system, Powerhand workshop lighting and various workshop equipment, Power-Start portable jump starters and Metrinch universal tools...

Serenco stands for high quality tools & service, ensuring support for their products long after the warranty period ends giving the user long term piece of mind.

SERENCO Serious Tools – Serious Results

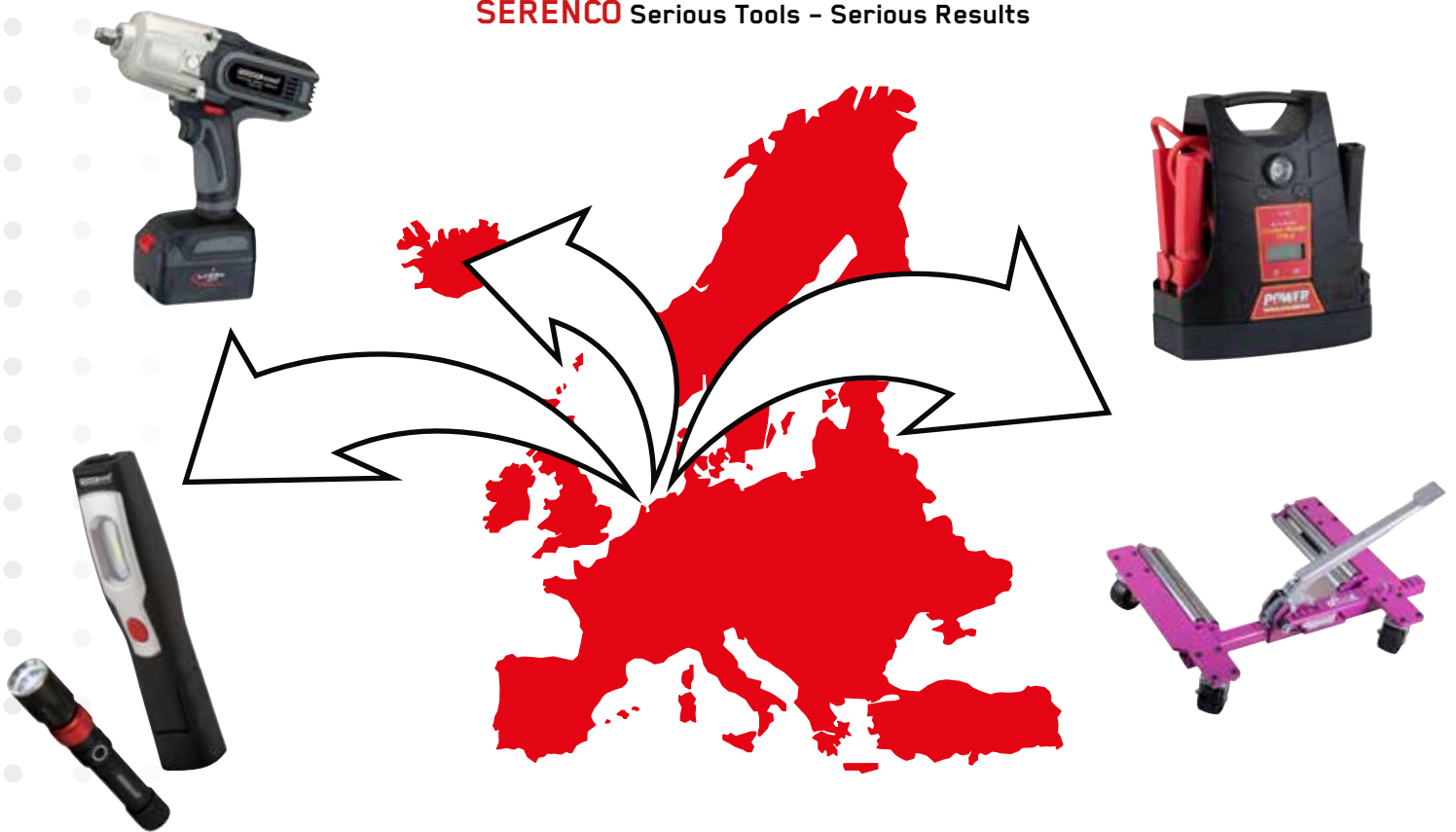

Remco Geirnaert
Director



Eveline Smits
Accounts



Marieke Serruijs
Marketing &
Communication



Aron van den Hoeven
Marketing &
Communication



Radjesh Harpal
Logistic manager



Logistics

From our central located warehouse in Maarsse, The Netherlands close to mainports Rotterdam and Schiphol we can ship globally in very short leadtimes. With a +1600 M2 warehouse carrying over 7.500 articles we can usually ship all orders direct from stock.

Note: for UK & Ireland contact SERENCO UK direct at: www.serenco.co.uk



Design & Innovation

New Tools and Storage solutions are developed in close cooperation with our partners. Tailor made solutions have been created for leading OE car manufacturers and are used worldwide. New projects are managed by our product development team.



Service & Support

Our full in-house after sales, repair & warranty department can quickly answer any technical inquiries. Our quality tools are designed for professional use and replacements parts for service and repair can be ordered long after the contractual warranty period.

SERENCO Web Support

Interactive configurator for Tool Trolleys and Organised Storage Modules to design and develop tailor made solutions for any new or existing workshop. Full Online Catalogue available in Magento 2.0.



Johan Gijsbertsen
Product manager/
Purchasing



Sjef van Belkom
Sales Manager



Anton van Zijveld
Export manager



Remco Worseling
Office staff sales



Jeroen van Ettinger
Office staff sales









POWER TOOLS



POWERHAND[®]
POWER FOR PROFESSIONALS

Our own range of Powerhand power tools are a well-established, high quality range of cordless Mini 10.8 V & 18 V Li-Ion tools. Our portfolio is mainly aimed at the automotive sector and includes a comprehensive range of impact wrenches, ratchets, caulking guns and more. All products are supplied with a 12 month warranty with full in-house after sales service. The range now, more than ever, lives up to its slogan 'Power for Professionals'.

SYMBOL GUIDE

 1/4" drive	 1/2" drive	 10.8 V Li-Ion range	 Blow mould case
 3/8" drive	 3/4" drive	 14.4 V Li-Ion range	K = 1 battery
		 18 V Li-Ion range	K2 = 2 batteries

SUB-SECTIONS

- 8** IMPACT WRENCHES
- 10** NEEDLE SCALERS
- 11** RIVETERS
- 12** RATCHETS, DRILLS AND DRIVERS
- 14** RATCHETS
- 15** GREASE GUN
- 16** CAULKING GUNS
- 20** GRINDERS & POLISHERS
- 22** BATTERIES
- 23** CHARGERS
- 24** SPARE PARTS

M26801138-SERIE

3/8" 10.8V

3/8" Cordless mini impact wrench Li-Ion

- Replaceable brushes in motor (PH-1056)



PH-10546



Replacement brushes for electric motor



Weight

M26801138	2.702 kg
M26801138-K2	2.924 kg

Ampere hour	1.5 Ah
Battery system	Click
Battery type	Li-ion
Charger	220 V
Charging time	1 Hour(s)
Max. torque	118 Nm
No load speed	0 ~ 1870 rpm

T76802258-SERIE

1/2" 18V

1/2" Cordless adjustable torque impact wrench Li-ion

This tool is intended for loosening and fastening bolts and nuts with the use of impact sockets and adaptors.

*Compact model

The increased mass of the impact parts enhances the moment of inertia of the impact energy.

Conventional impact mechanism motor



PH-10606



Torque settings

I	83 Nm
II	132 Nm
III	225 Nm
IV	382 Nm
V	431 Nm
VI	540 Nm



Weight

T76802258-K	5.09 kg
T76802258-K2	5.77 kg

Ampere hour	4 Ah
Battery system	Slide
Battery type	Li-ion
Charging time	1 Hour(s)
Length	242 mm
Max. torque	83 ~ 540 Nm
No load speed	1650 rpm

T76811158-SERIE

1/2" 18V

1/2" Cordless impact wrench Li-Ion, 880 Nm

This tool is intended for loosening and fastening bolts and nuts with the use of impact sockets and adaptors.

*Compact model

POWERHAND[®]
POWER FOR PROFESSIONALS

**NEW GENERATION
4 POLE MOTOR**

880 NM



Weight

T76811158-K	6.297 kg
T76811158-K2	6.93 kg

Ampere hour	4 Ah
Battery system	Slide
Battery type	Li-ion
Charging time	1 Hour(s)
Impacts per minute	2100
Max. torque	880 Nm
No load speed	1650 rpm

POWER TOOLS

AIR TOOLS

TOOL STORAGE

T76811358-SERIE

3/4" 18V

3/4" Cordless impact wrench Li-ion, 1000 Nm

This tool is intended for loosening and fastening bolts and nuts with the use of impact sockets and adaptors.

*Compact model

POWERHAND[®]
POWER FOR PROFESSIONALS

**NEW GENERATION
4 POLE MOTOR**

1000 NM



Weight

T76811358-K	6.292 kg
T76811358-K2	7.032 kg

Ampere hour	4 Ah
Battery system	Slide
Battery type	Li-ion
Charging time	1 Hour(s)
Impacts per minute	2100
Max. torque	1000 Nm
No load speed	1650 rpm

HAND TOOLS

WORKSHOP EQUIPMENT

SPECIALIST VEHICLE TOOLS

SIN-500.0012

Needle scaler pistol grip (small)

With this unique set, it is possible to change your hammer drill with SDS shaft in a professional needle scaler. No compressor needed. Insert the needle scaler into your (cordless) hammer drill and you can use it anywhere. The Powerhand needle scaler has hardened steel needles, which are very suitable for the removal of,

- Weldings
- Rust
- Paint
- Cement
- Glue and other residues

12x needles
180x3 mm



SIN-500.0019

Needle scaler pistol grip (large)

With this unique set, it is possible to change your hammer drill with SDS shaft in a professional needle scaler. No compressor needed. Insert the needle scaler into your (cordless) hammer drill and you can use it anywhere. The Powerhand needle scaler has hardened steel needles, which are very suitable for the removal of,

- Weldings
- Rust
- Paint
- Cement
- Glue and other residues

19 needles
120x3 mm



M26102138-SERIE

10.8 V

10.8 V Cordless riveter Li-Ion

Rivets:

- Aluminium Ø 4.8
- Steel Ø 4.8
- Stainless steel Ø 4.0

A fully charged battery can pull 230pc of Ø 4.8x10 mm rivets

Weight

M26102138K	2.776 kg
M26102138-K2	2.993 kg

Ampere hour	1.5 Ah
Battery system	Click
Battery type	Li-ion
Charging time	1 Hour(s)
No load speed	2.8 A
Rivet capacity	Ø 3.2, Ø 4, Ø 4.8 mm
Setting force	10612 N
Voltage	10.8 V

POWER HAND
POWER FOR PROFESSIONALS



PH-10546

- Ø 3.2: PH-10652
- Ø 4.0: PH-10651
- Ø 4.8: PH-10624
- Spanner PH-10653

Replacement brushes for electric motor



T76201158-SERIE

18 V

18 V Cordless nut riveter Li-Ion

- High torque motor 18 V
- Patented high torque mechanism
- Variable speed control
- Auto stop function
- Can set Nut rivets from M3 ~ M10
- All accessories in BMC
- No need to buy extra Heads or nose pieces
- 1 Hour intelligent charger

Weight

T76201158-K	5.003 kg
T76201158-K2	5.192 kg

Ampere hour	3 Ah
Battery system	Slide
Charging time	1 Hour(s)
No load speed	340 rpm
Rivet capacity	Alu-steel M3 ~ M10 mm
Voltage	18 V

POWER HAND
POWER FOR PROFESSIONALS



234 mm

28 mm



POWER TOOLS

AIR TOOLS

TOOL STORAGE

HAND TOOLS

WORKSHOP EQUIPMENT

SPECIALIST VEHICLE TOOLS

M26702138-SERIE

10.8 V

10.8 V Cordless 2 speed mini drill/driver Li-Ion

POWERHAND
POWER FOR PROFESSIONALS

- 11 Torque settings
- 2 Gear motor
- 2-component grip handle



PH-10261

Replacement brushes for electric motor



Weight

M26702138	2.622 kg
M26702138-K2	2.844 kg

Ampere hour	1.5 Ah
Battery system	Click
Charging time	1 Hour(s)
Chuck capacity	10 mm
Max. torque	23.5 Nm
No load speed	L: 0 ~ 360 / H: 0 ~ 1550 rpm
Torque selections	11 Nm

M26304138-SERIE

10.8 V

10.8 V Cordless 2 speed mini screwdriver Li-Ion

POWERHAND
POWER FOR PROFESSIONALS

- 11 Torque settings
- 2 Gear motor



PH-10546
Replacement brushes for electric motor



Weight

M26304138	2.622 kg
M26304138-K2	2.844 kg

Ampere hour	1.5 Ah
Battery system	Click
Charging time	1 Hour(s)
Max. torque	23.5 Nm
No load speed	L: 0 ~ 360 / H: 0 ~ 1550 rpm
Torque selections	11 Nm

M26601138-SERIE

1/4" 10.8V

1/4" Cordless mini impact driver Li-Ion

POWERHAND®
POWER FOR PROFESSIONALS



PH-10261



Replacement brushes for electric motor



Weight

M26601138	2.354 kg
M26601138-K2	2.576 kg

Ampere hour	1.5 Ah
Battery system	Click
Charging time	1 Hour(s)
Max. torque	118 Nm
No load speed	0 ~ 1870 rpm

U-M25602138

10.8V

Cordless led lamp (without battery)

POWERHAND®
POWER FOR PROFESSIONALS

- Body only
- Hanging hook
- Swivel head 90°
- Flexible hook
- 28 power-chip LEDs - work lamp
- 4 power-chip LEDs - spot light



30 Lumen

1 H

0.44 kg

SMD

-20~50°C

Ampere hour	1.5 Ah
Battery type	Li-ion
Brightness	30 Lumen
Brightness spot	30 Lumen
Charging time	1 Hour(s)
Led	28 + 4 LEDs
Max. run time	9 Hour(s)
Max. run time spot	40 Hour(s)



POWER TOOLS

AIR TOOLS

TOOL STORAGE

HAND TOOLS

WORKSHOP EQUIPMENT

SPECIALIST VEHICLE TOOLS

M25901238-SERIE

1/4" 10.8V

1/4" Cordless professional ratchet Li-Ion

POWERHAND®
POWER FOR PROFESSIONALS

Weight

M25901238	2.324 kg
M25901238-K2	2.55 kg

Ampere hour	1.5 Ah
Battery system	Click
Battery type	Li-ion
Charging time	1 Hour(s)
Max. torque	36 Nm
No load speed	220 rpm



M25902238-SERIE

1/2" 10.8V

1/2" Cordless professional ratchet Li-Ion

POWERHAND®
POWER FOR PROFESSIONALS

Weight

M25902238	3.04 kg
M25902238-K2	3.122 kg

Ampere hour	1.5 Ah
Battery system	Click
Battery type	Li-ion
Charging time	1 Hour(s)
Max. torque	65 Nm
No load speed	180 rpm



GREASE GUN



POWER TOOLS

AIR TOOLS

TOOL STORAGE

T75501158-SERIE

18 V

18 V Cordless grease gun Li-Ion

POWERHAND®
POWER FOR PROFESSIONALS

Pressure safety valve: This valve is set to 6250 psi. It will bypass the grease output when blocked lubricant line or clogged bearing occurs.



Weight

T75501158-K	8.05 kg
T75501158-K2	8.17 kg

Ampere hour	3 Ah
Battery system	Slide
Battery type	Li-ion
Charging time	1 Hour(s)
No load current	2.0 ~ 5.5 A



PH-10722 Lube shuttle adapter

HAND TOOLS

WORKSHOP EQUIPMENT

SPECIALIST VEHICLE TOOLS



T65806218-SERIE

3.6 V

3.6 V Cordless caulking gun Li-Ion



- Cordless caulking gun for both sausage bag and cartridge applications up to 310/400 ml
- High torque motor 3.6 V
- Patented high torque mechanism
- Patented driplless mechanism
- Patented rapid plunger release mechanism
- Variable speed control
- Auto stop function
- 1 Hour intelligent charger

Weight

T65806218-K	4.84 kg
T65806218-K2	5.18 kg

Ampere hour	2 Ah
Battery system	Click
Battery type	Li-ion
Capacity	310, 400 ml
Charging time	1 Hour(s)
Max. pushing force	300 Kgf
No load speed	3 ~ 8 mm/sec



T65806318-SERIE

3.6 V

3.6 V Cordless caulking gun Li-Ion for 310/400 & 600 ml



- Cordless caulking gun for both sausage bag and cartridge applications up to 310/400 & 600 ml
- High torque motor 3.6 V
- Patented high torque mechanism
- Patented driplless mechanism
- Patented rapid plunger release mechanism
- Variable speed control
- Auto stop function
- 1 Hour intelligent charger

Weight

M25902238-K	3.04 kg
M25902238-K2	3.122 kg

Ampere hour	2 Ah
Battery system	Click
Battery type	Li-ion
Capacity	310, 400, 600 ml
Charging time	1 Hour(s)
Max. pushing force	300 Kgf
No load speed	3 ~ 8 mm/sec

PH-10714 Lid
in combination with Plunjer PH-105-7



T65805238-SERIE

10.8 V

10.8 V Cordless caulking gun Li-Ion

POWER HAND®
POWER FOR PROFESSIONALS

- Cordless caulking gun for both sausage bag and cartridge applications up to 310/400 ml
- High torque motor 10.8 V
- Patented high torque mechanism
- Patented driplless mechanism
- Patented rapid plunger release mechanism
- Variable speed control
- Auto stop function
- 1 Hour intelligent charger



Weight

T65806218-K	4.84 kg
T65806218-K2	5.18 kg

Ampere hour	1.5 Ah
Battery system	Click
Battery type	Li-ion
Capacity	310, 400 ml
Charging time	1 Hour(s)
Max. pushing force	450 Kgf
No load speed	10 mm/sec



T65805338-SERIE

10.8 V

10.8 V Cordless caulking gun Li-Ion for 310/400 & 600 ml

POWER HAND®
POWER FOR PROFESSIONALS

- Cordless caulking gun for both sausage bag and cartridge applications up to 310/400 & 600 ml
- High torque motor 10.8 V
- Patented high torque mechanism
- Patented driplless mechanism
- Patented rapid plunger release mechanism
- Variable speed control
- Auto stop function
- 1 Hour intelligent charger



Weight

T65805338-K	5.41 kg
T65805338-K2	5.57 kg

Ampere hour	1.5 Ah
Battery system	Click
Battery type	Li-ion
Capacity	310, 400, 600 ml
Charging time	1 Hour(s)
Max. pushing force	450 Kgf
No load speed	10 mm/sec



POWER TOOLS

AIR TOOLS

TOOL STORAGE

HAND TOOLS

WORKSHOP EQUIPMENT

SPECIALIST VEHICLE TOOLS

T75804248-SERIE

14.4 V

14.4 V Cordless caulking gun Li-Ion

POWER HAND®
POWER FOR PROFESSIONALS

- Cordless caulking gun for both sausage bag and cartridge applications up to 310/400 ml
- High torque motor 14.4 V
- Patented high torque mechanism
- Patented driplless mechanism
- Patented rapid plunger release mechanism
- Variable speed control
- Auto stop function
- 1 Hour intelligent charger



Weight

T75804248-K	5.82 kg
T75804248-K2	6.37 kg

Ampere hour	3 Ah
Battery system	Slide
Battery type	Li-ion
Capacity	310, 400 ml
Charging time	1 Hour(s)
Max. pushing force	650 Kgf
No load speed	10 mm/sec



Cartridge

Sausage bag



T75804348-SERIE

14.4 V

14.4 V Cordless caulking gun Li-Ion for 310/400 & 600 ml

POWER HAND®
POWER FOR PROFESSIONALS

- Cordless caulking gun for both sausage bag and cartridge applications up to 310/400 & 600 ml
- High torque motor 14.4 V
- Patented high torque mechanism
- Patented driplless mechanism
- Patented rapid plunger release mechanism
- Variable speed control
- Auto stop function
- 1 Hour intelligent charger



Weight

T75804348-K	5.37 kg
T75804348-K2	6.549 kg

Ampere hour	3 Ah
Battery system	Slide
Battery type	Li-ion
Capacity	310, 400, 600 ml
Charging time	1 Hour(s)
Max. pushing force	650 Kgf
No load speed	10 mm/sec



Cartridge

Sausage bag





POWER HAND[®]
 POWER FOR PROFESSIONALS



POWER TOOLS

AIR TOOLS

TOOL STORAGE

HAND TOOLS

WORKSHOP EQUIPMENT

SPECIALIST VEHICLE TOOLS

M25101138-SERIE

10.8 V

10.8 V Cordless die grinder Li-Ion

POWERHAND®
POWER FOR PROFESSIONALS

EGPF2001
Set of replacement grinding stones, 10pc
(Accessory, not included)

Weight

M25101138	2.3.13 kg
M25101138-K2	2.492 kg

Ampere hour	1.5 Ah
Battery system	Click
Battery type	Li-ion
Charging time	1 Hour(s)
No load current	3.0 A
No load speed	22000 rpm



M25701138-SERIE

10.8 V

10.8 V Cordless polisher Li-Ion

POWERHAND®
POWER FOR PROFESSIONALS

- 75 mm disc size

Weight

T75804348	5.37 kg
T75804348-K2	6.549 kg

Ampere hour	1.5 Ah
Battery system	Click
Battery type	Li-ion
Charging time	1 Hour(s)
Disc diameter	75 mm
No load current	3.0 A
No load speed	3000 rpm
Path thread size	M6xP1.25



T75101458-SERIE

18 V

18 V Cordless angle grinder Li-Ion

POWERHAND[®]
POWER FOR PROFESSIONALS

- Powerful 18 V motor
- Integrated ventilation system
- 2 Position side handle
- All metal bevelled gearing
- Capable of using cutting or grinding wheels
- Wheel size 115 mm
- 1 hour intelligent charger

Weight

T75101458-K	5.063 kg
T75101458-K2	5.742 kg

Ampere hour	3 Ah
Battery system	Slide
Battery type	Li-ion
Charging time	1 Hour(s)
Disc diameter	115 mm
No load speed	7000 rpm
Spindle thread	M14



T75701158-SERIE

18 V

18 V Cordless random orbit polisher Li-Ion

POWERHAND[®]
POWER FOR PROFESSIONALS

- Quick & easy car polishing
- Variable speed for different applications
- Velcro design for easy changing polishing cloths

Weight

T75701158-K	8.05 kg
T75701158-K2	8.17 kg

Ampere hour	3 Ah
Battery system	Slide
Battery type	Li-ion
Charging time	1 Hour(s)
Disc diameter	Velcro 125 mm
No load speed	1300 ~ 3800 rpm
Spindle thread size	M14



POWER TOOLS

AIR TOOLS

TOOL STORAGE

HAND TOOLS

WORKSHOP EQUIPMENT

SPECIALIST VEHICLE TOOLS

B3011820 3.6 V B303138 10.8 V B30313820 10.8 V

Battery 3.6 V, 2 Ah, Li-Ion, click-system

Click battery 10.8 V, 1,5 Ah, Li-Ion

Battery 10.8 V, 2 Ah, Li-Ion, click-system



B308148 14.4 V B309148 14.4 V B30914840 14.4 V

Battery 14.4 V, 2 Ah, Li-Ion, slide-system

Battery 14.4 V, 3 Ah, Li-Ion, slide-system

Battery 14.4 V, 4 Ah, Li-Ion, slide-system



B309158 18 V B30915840 18 V

Battery 18 V, 3 Ah, Li-Ion, slide-system

Battery 18 V, 4 Ah, Li-Ion, slide-system



CHARGERS

C1011018

3.6 V

Charger 3.6 V, Li-ion



C1031038

Charger 10.8 V, Li-Ion



10.8 V

C1081358

Charger 10.8, 14.4, 18 V, Li-Ion



10.8 V

14.4 V

18 V

C1121358

Car charger for 10.8, 14.4, 18 V, Li-ion

10.8 V

14.4 V

18 V



POWER TOOLS

AIR TOOLS

TOOL STORAGE

HAND TOOLS

WORKSHOP EQUIPMENT

SPECIALIST VEHICLE TOOLS

PH-10261

Replaceable brush for motor
M26702138 and M26601138



PH-10546

Replaceable brushes for motor
M26801138 and M26304138

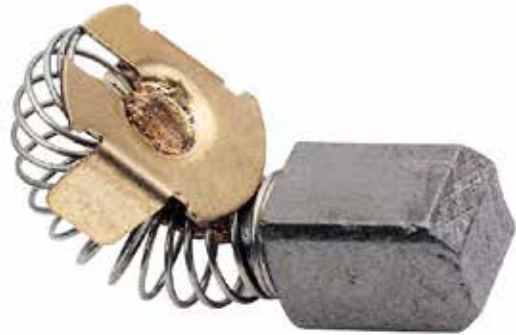

PH-10606

Replaceable brushes for motor
T76802258



SIN-500.0801A

Needle set for scaler SIN-500.0012

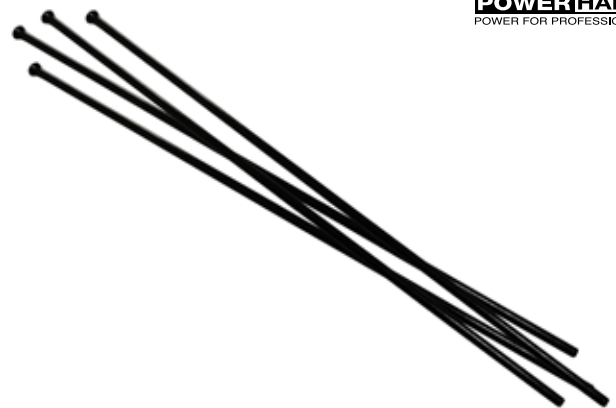

POWERHAND®
POWER FOR PROFESSIONALS

SIN-500.0125

Spring for scaler SIN-500.0012

▪ 24 mm



POWERHAND®
POWER FOR PROFESSIONALS

SIN-500.0195

Spring for scaler SIN-500.0019

▪ 32 mm



POWERHAND®
POWER FOR PROFESSIONALS

SIN-500.0196

Needle set for scaler SIN-500.0019



POWERHAND®
POWER FOR PROFESSIONALS



POWER TOOLS

AIR TOOLS

TOOL STORAGE

HAND TOOLS

WORKSHOP EQUIPMENT

SPECIALIST VEHICLE TOOLS

AIR TOOLS





Our range contains impact solutions from 1/4" to 1", including sockets, socket bits, extension bars, adapters and universal joints for everyday workshop and industrial use.















Our patented Metrinch wall drive profile drives only on the flats and not the corners, with specific calculations to enable a single Metrinch tool to be used on both metric and inch (AF, BSW & BSF) series fasteners. The specialist nature of Metrinch sockets and spanners make them ideal for use on worn and damaged bolts or even those completely rounded by abrasion.



Eagle offers a comprehensive range of pneumatic tools for professional, daily use in automotive and industrial workshops. Featuring low vibration and noise qualities, composite handles and paddle style triggers on many of the units for improved user speed control. With a portfolio that includes Mini air tools, impact wrenches, ratchets, drills, die grinders, cutting, sanding and specialist tools there is a solution available for any busy workshop. New products in this issue include the extra-short 3/8" and 1/2" impact wrenches and low profile impact sockets and socket sets to enhance the usage of these tools. All products are supplied with a 12 month warranty with full in-house after sales service.

SYMBOL GUIDE

 1/4" drive	 1/2" drive	 Blow mould case	 Chrome Molybdenum
 3/8" drive	 3/4" drive	 6 point	 TX
	 1" drive	 Spline	 Male
		 Flank drive	 Female

SUB-SECTIONS

- 28** AIR IMPACT WRENCHES
- 32** AIR RATCHETS
- 36** AIR DRILLS
- 37** AIR GRINDERS
- 38** AIR GRINDERS AND CUTTERS
- 39** AIR CUTTERS, SANDERS AND POLISHERS
- 40** AIR SANDERS
- 41** AIR TOOLS FOR THE SPECIALIST
- 46** ACCESSORIES AND SPARE PARTS
- 51** IMPACT SOCKETS
- 52** 3/8" IMPACT SOCKETS
- 54** 1/2" IMPACT SOCKETS
- 58** 3/4" IMPACT SOCKETS
- 59** 1" IMPACT SOCKETS

EG2480

3/8"

3/8" Extra-short impact wrench

- Extra short body with huge torque output
- Reinforced, lightweight aluminium housing and alloy steel front bushing, for durability
- Refined hammer impact mechanism
- 3 settings in forward, and 3 in reverse
- One-hand operated
- Variable speed control with tease trigger
- Ergonomic comfort-grip handles



Eagle

Air consumption	134 l/m
Air inlet	1/4"
Max. air pressure	6.2 bar
Max. torque	563 Nm
Noise level	95 dB(A)
No load speed	9000 rpm
Vibrations	4.5 m/s ²
Weight	1.3 kg
Length	109 mm

EG2460

1/2"

1/2" Extra-short impact wrench

- Extra short body with huge torque output
- Reinforced, lightweight aluminium housing and alloy steel front bushing, for durability
- Refined hammer impact mechanism
- 3 settings in forward, and 3 in reverse
- One-hand operated
- Variable speed control with tease trigger
- Ergonomic comfort-grip handles



Eagle

Air consumption	134 l/m
Air inlet	1/4"
Max. air pressure	6.2 bar
Max. torque	677 Nm
Noise level	95 dB(A)
No load speed	9000 rpm
Vibrations	4.5 m/s ²
Weight	1.3 kg
Length	109 mm

NI4304

1/2"

1/2" Composite impact wrench

- Switch has 3 levels



Air consumption	139 l/m
Max. air pressure	6.2 bar
Max. torque	1111 Nm
Noise level	99 dB(A)
No load speed	8500 rpm
Weight	2.1 kg
Length	190 mm



EG1460

1/2"

1/2" Impact wrench 1090 Nm



- Switch has 3 levels
- Powerful Twin hammer
- Ideal for every tire shop/fitter
- Low vibrations level
- Composite housing

Air consumption	170 l/m
Air inlet	1/4"
Max. air pressure	6.2 bar
Max. torque	1090 Nm
Noise level	99 dB(A)
No load speed	7500 rpm
Vibrations	4,51 m/s ²
Weight	2.1 kg
Length	185 mm



EG2560

1/2"

1/2" Composite impact wrench 1486 Nm

- Switch has 3 levels
- L/R changeable with just one hand
- Short model for a better reach
- Powerful Twin hammer
- Low air consumption - 113 l/m
- Ergonomic comfort grip
- User can be right or left handed
- Ideal for every tire shop/fitter
- Low vibrations level
- Composite housing



Air consumption	113 l/m
Air inlet	1/4"
Max. air pressure	6.2 bar
Max. torque	1486 Nm
Noise level	96 dB(A)
No load speed	8500 rpm
Vibrations	12.92 m/s ²
Weight	1.95 kg
Length	171 mm



POWER TOOLS

AIR TOOLS

TOOL STORAGE

HAND TOOLS

WORKSHOP EQUIPMENT

SPECIALIST VEHICLE TOOLS

EG557A

3/8"

3/8" High torque angle head Impact wrench

An impact wrench with easy access in hard to reach areas.

- Workable head is 50 mm high
- Reactionless torque allows the user to safely use this high impact torque wrench
- Patented cooling system
- Comfortable switch which enables the user to get precise and smooth speed control
- 360 degree adjustable air exhaust



Air consumption	91 l/m
Air inlet	1/4"
Max. air pressure	6.2 bar
Max. torque	271 Nm
Noise level	92.5 dB(A)
No load speed	6000 rpm
Vibrations	0.85 m/s ²
Weight	1.98 kg
Length	332 mm

EG557B

1/2"

1/2" High torque angle head Impact wrench

An impact wrench with easy access in hard to reach areas.

- Workable head is 50 mm high
- Reactionless torque allows the user to safely use this high impact torque wrench
- Patented cooling system
- Comfortable switch which enables the user to get precise and smooth speed control
- 360 degree adjustable air exhaust



Air consumption	91 l/m
Air inlet	1/4"
Max. air pressure	6.2 bar
Max. torque	271 Nm
Noise level	92.5 dB(A)
No load speed	6000 rpm
Vibrations	0.85 m/s ²
Weight	1.98 kg
Length	332 mm

EG663

3/4"

3/4" Impact wrench

- High performance torque twin hammer mechanism with durable body for heavy duty applications
- Forward/reverse power regulator with different power setting for maximum power
- Twin hammer



Eagle

Air consumption	155 l/m
Air inlet	3/8"
Max. torque	1491 Nm
Noise level	87 dB(A)
No load speed	7200 rpm
Vibrations	4.5 m/s ²
Weight	2.87 kg
Length	177 mm

EG1662C

1"

Super duty 1" composite air impact wrench

- Compact and lightweight
- High torque output
- Built-in Power Regulator
- Controllable throttle provides easy bolt starting
- 6" extended anvil
- Clutch Type: Twin Hammer
- Air Hose ID: 1/2"

**SUPER LIGHTWEIGHT
7.0 KG!**



Eagle

Air consumption	340 l/m
Air inlet	3/8"
Max. air pressure	6.2 bar
Max. torque	2983 Nm
Noise level	124.6 dB(A)
No load speed	5500 rpm
Vibrations	4.5m/s ²
Weight	7.0 kg
Length	528 mm

POWER TOOLS

AIR TOOLS

TOOL STORAGE

HAND TOOLS

WORKSHOP EQUIPMENT

SPECIALIST VEHICLE TOOLS

EG553

1/4"

1/4" Mini ratchet



Eagle

Air consumption	85 l/m
Air inlet	1/4"
Max. torque	32 Nm
Noise level	92 dB(A)
No load speed	240 rpm
Vibrations	10.5 m/s ²
Weight	0.5 kg
Length	120 mm

EG552

1/4" 3/8"

1/4" & 3/8" Mini ratchet



Eagle

Air consumption	85 l/m
Air inlet	1/4"
Max. torque	32 Nm
Noise level	92 dB(A)
No load speed	240 rpm
Vibrations	10.5 m/s ²
Weight	0.5 kg
Length	120 mm

EG561A

1/4"

1/4" Ratchet

- Composite housing



Eagle

Air consumption	70 l/m
Air inlet	1/4"
Max. torque	41 Nm
Noise level	97 dB(A)
No load speed	240 rpm
Vibrations	1.61 m/s ²
Weight	0.5 kg
Length	175 mm

EG561B

3/8"

3/8" Ratchet

- Composite housing



Eagle

Air consumption	70 l/m
Air inlet	1/4"
Max. torque	41 Nm
Noise level	97 dB(A)
No load speed	240 rpm
Vibrations	1.61 m/s ²
Weight	0.5 kg
Length	175 mm

POWER TOOLS

AIR TOOLS

TOOL STORAGE

HAND TOOLS

WORKSHOP EQUIPMENT

SPECIALIST VEHICLE TOOLS

EG700

3/8"

3/8" Air ratchet

The EG700 ratchet is a rugged, variable speed reversible air ratchet. The paddle style trigger provides better speed control and the polyurethane handle helps maintain temperature and insulate vibration. These features make this ratchet ideal for automotive fastener removal and installation work.

- Composite housing



Eagle

Air consumption	85 l/m
Air inlet	1/4"
Max. torque	70 Nm
No load speed	175 rpm
Vibrations	0.4 m/s ²
Noise level	85 dB
Weight	1.25 kg
Length	264 mm

EG705

1/2"

1/2" Air ratchet

The EG705 ratchet is a rugged, variable speed reversible air ratchet. The paddle style trigger provides better speed control and the polyurethane handle helps maintain temperature and insulate vibration. These features make this ratchet ideal for automotive fastener removal and installation work.

- Composite housing



Eagle

Air consumption	85 l/m
Air inlet	1/4"
Max. torque	70 Nm
No load speed	175 rpm
Vibrations	0.4 m/s ²
Noise level	85 dB
Weight	1.25 kg
Length	264 mm

EG554A

3/8"

3/8" Reactionless ratchet

- Composite housing



Air consumption	99 l/m
Air inlet	1/4"
Max. torque	95 Nm
No load speed	300 rpm
Vibrations	2.2 m/s ²
Noise level	90 dB
Weight	0.9 kg
Length	195 mm

EG554B

1/2"

1/2" Reactionless ratchet

- Composite housing



Air consumption	99 l/m
Air inlet	1/4"
Max. torque	95 Nm
No load speed	300 rpm
Vibrations	2.2 m/s ²
Noise level	84 dB
Weight	1.35 kg
Length	310 mm

POWER TOOLS

AIR TOOLS

TOOL STORAGE

HAND TOOLS

WORKSHOP EQUIPMENT

SPECIALIST VEHICLE TOOLS

EG213-19R

Reversible drill 10 mm

Ergonomic comfort-grip handle maintains a comfortable temperature during operation and insulates against vibration

- Composite housing



Air consumption	100 l/m
Air inlet	1/4"
Chuck size	10 mm
Noise level	90 dB(A)
No load speed	1800 rpm
Vibrations	0.4 m/s ²
Weight	0.9 kg
Length	195 mm

EG225-19R

90° Angle drill 10 mm

- Composite housing

LOW NOISE!



Air consumption	85 l/m
Air inlet	1/4"
Chuck size	10 mm
Noise level	83 dB(A)
No load speed	1800 rpm
Vibrations	0.6 m/s ²
Weight	1.1 kg
Length	220 mm

EG327HN

Spot weld drill, boron killer, uses tungsten carbide drills

- Innovation from original manufacturer
- Ideal for speedy removal of spot welds on vehicle bodywork
- Newly designed high efficient motor submit greater power
- Two-tier planetary gear system triple the output torque to meet the requirement of drilling high strength body material BTR, BOR and USIBOR etc..
- Floating spindle isolated from motor and gear system to reduce the vibration to the minimum
- Double row angular bearing give the best support against axial feeding thrust
- Variable speed throttle control allows easy operation
- Control collar (feeding adjustable ring) allows precise setting of drilling depth
- The Brace & Feeder Assembly can be rotated 360 degree and removed, and also prevent side-slipping of drill when working
- With one piece of HSS drilling bit (8 mm shank x 8.0 mm)



Air consumption	170 l/m
Air inlet	1/4"
Noise level	90 dB(A)
No load speed	1100 rpm
Vibrations	0.3 m/s ²
Weight	1.71 kg
Length	252 mm



AIR GRINDERS

EG120K-19R

Mini die grinder kit 15pc

Contents:

- EG120ST
- 1/4" Mini die grinder
- 10 grinding stones
- 3.6 mm



Eagle



EG120ST

Mini die grinder

- Ergonomic cushion-grip handles insulate against vibration, reducing operator fatigue
- Power/speed regulator allows for easy rpm adjustment
- Rear exhaust directed away from the user and the working areas
- Twin bearing spindle, results in super precise spindle concentricity and minimal vibration
- Composite housing



Eagle

Air consumption	85 l/m
Air inlet	1/4"
Collet size	6 mm
Noise level	85 dB(A)
No load speed	2500 rpm
Vibrations	0.4 m/s ²
Weight	1.35 kg
Length	310 mm

EG210K-19R

Angle grinder kit

This tool is intended for grinding, chamfering, deburring and light cleaning operations using accessories with the proper fittings.

- Built-in comfort grip
- Rear exhaust with silencer
- Rotating air inlet
- Safety throttle lever
- Air regulator on top



Eagle

Air consumption	105 l/m
Air inlet	1/4"
Collet size	3,6 mm
Noise level	85 dB(A)
No load speed	18000 rpm
Vibrations	0.5 m/s ²
Weight	0.7 kg
Length	178 mm



EG125-19R

90° Mini die grinder

- Composite housing
- Low noise machine

LOW NOISE!



Eagle

Air consumption	59 l/m
Air inlet	1/4"
Collet size	6 mm
Noise level	82 dB(A)
No load speed	20000 rpm
Vibrations	0.5 m/s ²
Weight	0.7 kg
Length	155 mm

POWER TOOLS

AIR TOOLS

TOOL STORAGE

HAND TOOLS

WORKSHOP EQUIPMENT

SPECIALIST VEHICLE TOOLS

EG255A

Extended reach cut-off tool

This tool is intended for the cutting of metal parts in combination with good quality proper fitting cut-off wheels.



- Comfort grip
- Rear exhaust
- Air regulator on top
- Adjustable guard
- Composite housing



Air consumption	116 l/m
Air inlet	1/4"
Max. air pressure	6.2 bar
Max. diameter cut-off wheel	100 mm
Max. free speed	14000 rpm
Noise level	87 dB(A)
Spindle size	6 mm
Vibrations	1.3 m/s ²
Weight	1.4 kg
Length	345 mm

EG805

Heavy duty grinder/cut off tool

- Composite housing
- 125 mm

LOW NOISE!



125 mm



Air consumption	142 l/m
Air inlet	1/4"
Collet size	Axle size 22 mm
Noise level	80 dB(A)
No load speed	10000 rpm
Vibrations	0.5 m/s ²
Weight	1.5 kg
Length	244 mm

EG250-19R

75 mm Cut-off tool 75 mm

The ultimate heavy duty cut-off tool featuring

- Stall torque resistance - Twice that of regular tools - Outperforming alternatives on the market
- Powerful twin-chamber motor - Delivers much higher torque and power than that of conventional air motor - Significantly increasing efficiency
- Ergonomic comfort-grip handle - Maintains a comfortable temperature during operation and insulates against vibration
- Composite housing



75 mm

Air consumption	85 l/m
Air inlet	1/4"
Collet size	6 mm
Noise level	87 dB(A)
No load speed	21000 rpm
Vibrations	0.8 m/s ²
Weight	0.75 kg
Length	193 mm

EG178

HD saw

- Composite housing
- Capacity: 3 mm



Eagle

Air consumption	36 l/m
Air inlet	1/4"
Noise level	88 dB(A)
No load speed	9500 blows p/m
Vibrations	3 m/s ²
Weight	0.55 kg
Length	160 mm

EG1060

Mini pro sander 50 or 75 mm

- Sanding pad 50 or 75 mm
- Air consumption 57 l/m

EGD001021060 = pad 50 mm
EGD001031060 = pad 75 mm



Eagle

Air consumption	57 l/m
Air inlet	1/4"
Noise level	89.4 dB(A)
No load speed	15000 blows p/m
Vibrations	< 2.5 m/s ²
Weight	0.46 kg
Length	109 mm

EG1062

Mini pro polisher 75 mm

- Polish pad 75 mm
- Air consumption 61 l/m

EG1062-2 = pad 50 mm
EG1062-3 = pad 75 mm



Eagle

Air consumption	61 l/m
Air inlet	1/4"
Noise level	89.4 dB(A)
No load speed	6000 blows p/m
Vibrations	< 2.5 m/s ²
Weight	0.7 kg
Length	130 mm

EG01-3-C6-19R

Orbital sander central vacuum 2.5 mm orbit

This tool is intended for sanding in combination with good quality proper fitting accessories. Use 150 mm diameter 15 hole Velcro sanding discs.

- 2.5 mm Ø orbit
- Well-balanced
- 360° Air exhaust
- Low vibration
- Central Vacuum
- Lightweight composite housing
- Pad diameter 150 mm



LOW NOISE!

Eagle

Air consumption	310 l/m
Air inlet	1/4"
Max. air pressure	6.2 bar
No load speed	10000 rpm
Noise level	80 dB(A)
Sanding stroke	2.5 mm
Vibrations	0.8 m/s ²
Weight	0.9 kg

EG01-C6-19R

Orbital sander central vacuum 5 mm orbit

- 5 mm orbit
- Well-balanced
- 360° Air exhaust
- Low vibration
- Central Vacuum
- Lightweight composite housing
- Pad diameter 150 mm



LOW NOISE!

Eagle

Air consumption	310 l/m
Air inlet	1/4"
Max. air pressure	6.2 bar
No load speed	10000 rpm
Noise level	80 dB(A)
Sanding stroke	5 mm
Vibrations	0.8 m/s ²
Weight	0.9 kg

EG702A

Belt sander 10x330 mm



Eagle

Air consumption	57 l/m
Air inlet	1/4"
No load speed	18000 rpm
Noise level	85 dB(A)
Vibrations	0.4 m/s ²
Weight	0.8 kg
Length	290 mm

EG707

Belt sander 20x520 mm



Eagle

Air consumption	70 l/m
Air inlet	1/4"
No load speed	16000 rpm
Noise level	85 dB(A)
Vibrations	0.3 m/s ²
Weight	1.2 kg
Length	350 mm

EG280

Surface Preparation tool without vacuum

This tool is intended for removing striping of vehicles in combination with an eraser wheel.



Eagle

Air consumption	100 l/m
Air inlet	1/4"
Max. air pressure	6.2 bar
No load speed	4000 rpm
Noise level	85 dB(A)
Vibrations	0.5 m/s ²
Weight	1.2 kg
Length	254 mm

EG280K-6

Surface Preparation system without vacuum - set

This tool is intended for removing striping of vehicles in combination with the supplied eraser wheel. Toolset without vacuum, with accessories



Eagle

Air consumption	100 l/m
Air inlet	1/4"
Max. air pressure	6.2 bar
No load speed	4000 rpm
Noise level	85 dB(A)
Vibrations	0.5 m/s ²
Weight	1.2 kg
Length	254 mm



EG280CK-6

Surface preparation system with vacuum - set

This tool is intended for removing striping of vehicles in combination with the supplied eraser wheel.

- Different type wheels (for the preparation of metal surfaces prior to remedial work)
- Safety guard (protecting user from debris/sparks)
- Safety throttle lever
- Rear exhaust
- Wire brush
- Rubber eraser



Eagle

Air consumption	100 l/m
Air inlet	1/4"
Max. air pressure	6.2 bar
No load speed	4000 rpm
Noise level	85 dB(A)
Vibrations	0.5 m/s ²
Weight	1.2 kg
Length	254 mm



EG260S-19R

Smart Eraser

- Composite housing
- Designed to get rid of any kind of marks on plastic or painted surfaces
- Removal of marks is very fast, without damaging the surface
- Special rubber wheel included (90x15 mm)



Eagle

Air consumption	85 l/m
Air inlet	1/4"
Noise level	84 dB(A)
No load speed	2600 rpm
Vibrations	0.7 m/s ²
Weight	1 kg
Length	225 mm

EG2260E

Pneumatic angular stripping remover



Eagle

Air consumption	99 l/m
Air inlet	1/4"
Noise level	86 dB(A)
No load speed	2500 rpm
Max. air pressure	6.2 bar
Vibrations	1.2 m/s ²
Weight	1 kg
Length	220 mm

EG671CF

Needle scaler



Eagle

Air consumption	280 l/m
Air inlet	1/4"
Noise level	96.6 dB(A)
No load speed	3700 blows p/m
Vibrations	6.9 m/s ²
Weight	2.7 kg
Length	335 mm

EG672CF

Needle scaler pistol grip



Eagle

Air consumption	280 l/m
Air inlet	1/4"
Noise level	96.6 dB(A)
No load speed	3700 blows p/m
Vibrations	6.9 m/s ²
Weight	3 kg
Length	335 mm

EG308

Oscillating knife kit

Eagle



Air consumption	113 l/m
Air inlet	1/4"
Noise level	89 dB(A)
No load speed	20000 rpm
Vibrations	2.2 m/s ²
Weight	0.97 kg
Length	195 mm

EG-01-06-0012

Hammer kit

Includes 5 chisels and spring retainer

Eagle



Air consumption	269 l/m
Air inlet	1/4"
Noise level	94 dB(A)
No load speed	4300 blows p/m rpm
Vibrations	15 m/s ²
Weight	2.45 kg
Length	320x240 mm



EG6062

Engraving pen

LOW NOISE!

Eagle



Air consumption	74 l/m
Air inlet	1/4"
Noise level	76 dB(A)
No load speed	13000 blows p/m
Vibrations	0.7 m/s ²
Weight	0.22 kg
Length	140 mm

EG01-009-0009

Punch and flange tool

- Capacity: 1.2 mm (Steel)
2.0 mm (Aluminum)
- Punch Dia.: 5 mm

Eagle



Air inlet	1/4"
Noise level	76 dB(A)
Vibrations	2.5 m/s ²
Weight	1.25 kg
Length	248 mm

EG175HY

Nibbler

- Lightweight and durable pistol grip for great control
- Heavy duty cutting blades make clean cut in cold rolled steel up to 20 gauge
- Polyurethane handle helps maintain temperature and insulate against vibration
- Ideal for trimming, outlining and shearing various sheet metal
- Composite housing

Eagle



Air consumption	85 l/m
Air inlet	1/4"
Capacity	1.5 mm
Noise level	90 dB(A)
No load speed	2600 rpm
Vibrations	0.8 m/s ²
Weight	1 kg
Length	178 mm

EG320

Shear

- Lightweight and durable pistol grip for great control
- Heavy duty cutting blades make clean cut in cold rolled steel up to 20 gauge
- Polyurethane handle helps maintain temperature and insulate against vibration
- Ideal for trimming, outlining and shearing various sheet metal
- Composite housing

Eagle



Air consumption	85 l/m
Air inlet	1/4"
Capacity (mm)	Steel: 1.2 - Alu: 1.6
Noise level	86 dB(A)
No load speed	2600 rpm
Vibrations	0.7 m/s ²
Weight	1 kg
Length	240 mm

POWER TOOLS

AIR TOOLS

TOOL STORAGE

HAND TOOLS

WORKSHOP EQUIPMENT

SPECIALIST VEHICLE TOOLS

EG195

Caulking gun

- One finger trigger to feed the material for construction and automotive repair
- Capacity: 310 ml
- Pressure: 2.5 ~ 5.1 bar



Eagle

Air inlet	1/4"
Weight	1.1 kg
Length	325 mm

SIN-300.2010

Typhoon cleaning gun

Uses air pressure and user-added detergent to create a directed blast of air and detergent for cleaning interior and bodywork.



POWERHAND®
POWER FOR PROFESSIONALS

Air consumption	130 l/m
Max. air pressure	8 bar

X-EG179

Suction/blower gun kit

Includes flexible tube, extension tube, small tube, flat tube, brush and dust bag



Eagle

Air inlet	1/4"
Max. air pressure	6.2 bar

GJQS9000R

Vacuum Quick Spiff

Makes cleaning up almost fun. It's so quick and easy, it's like having your own personal tornado pick up whatever mess you make. Quick Spiff™ is completely self-contained: no tubes, no tanks, no trouble. Just connect an air-line and pick up dirt, dust, nuts, bolts or whatever. You'll be amazed at the pulling power this vacuum unit develops. Quick Spiff™ includes assorted attachments to get into range of places and hard-to-reach spots and its heavy duty dust collector bag empties in seconds. When time means money, Quick Spiff™ gives you more.

- Comfortable
- Heavy duty
- Easy-empty dust bag (GJQS-12)
- Rear deflector extends bag life

GJQS-12



GOJAK™
THE FASTER CASTER SYSTEM™

Air consumption	283 l/m
Air inlet	1/4"
Max. air pressure	6.2 bar
Weight	0.4 kg

GJ007R

Sand blaster

Rust, scale and corrosion are tough to fully remove. Blasting high-speed media particles at the work piece is the best way to get into all the small niches in the metal to ensure complete removal. Speed Blaster® gravity fed, safety vented reservoir tank eliminates tubes or siphon hoses that can easily clog. Speed Blaster runs continuously and virtually clog free with the correct media and moisture-free air. And you can use a variety of blast media that do not exceed 14 grit. The lightweight, long-lasting, comfortable design employs gravity to help force the blast media into a hardened steel mixing chamber. Compressed air then forces the particles through a top grade alumina ceramic nozzle at extraordinary velocity. Speed Blaster is self-contained and small for easy storage in a toolbox drawer. The next time you need to blast something, just connect compressed air and go.



Air consumption	280 l/m
Container capacity	0.75 L
Fitting Size	1/4"
Material	ABS
Working pressure	5 ~ 7 bar
Weight	0.460 kg



POWER TOOLS

AIR TOOLS

TOOL STORAGE

HAND TOOLS

WORKSHOP EQUIPMENT

SPECIALIST VEHICLE TOOLS

EG119M

Magnetic toolholder



- For carlift or tool boxes
- Extra strong magnets



EG327B-SERIE

Accessories for EG327HN



	Material	Ø	Pc
EG327B-TC1	Tungsten-carbide	8 mm	1
EG327BH-65K	Titanium coated	6 mm	5
EG327BH-80K	Titanium coated	8 mm	5

EGPF2001

Set of replacement grinding stones 10pc



EG21036-2

Collet Ø 3 mm



EG702A001

Grinding belt 10x330 mm



EG7070007

Grinding belt 20x520 mm



EGBEZD3018A

Saw 18-t for EG178 5pc

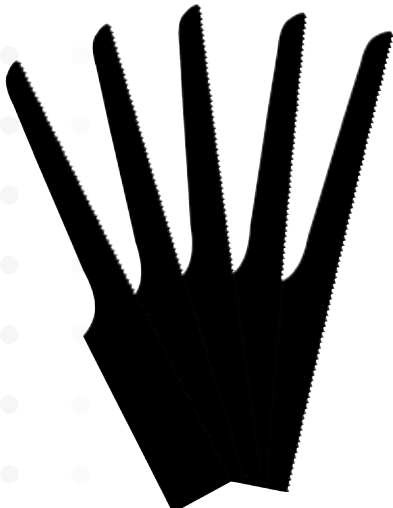

EGBEZD3024A

Saw 24-t for EG178 5pc

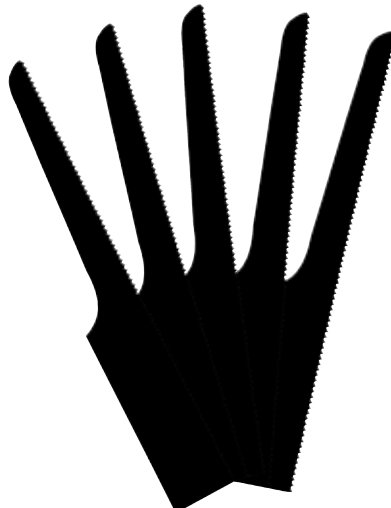

EGBEZD3032A

Saw 32-t for EG178 5pc

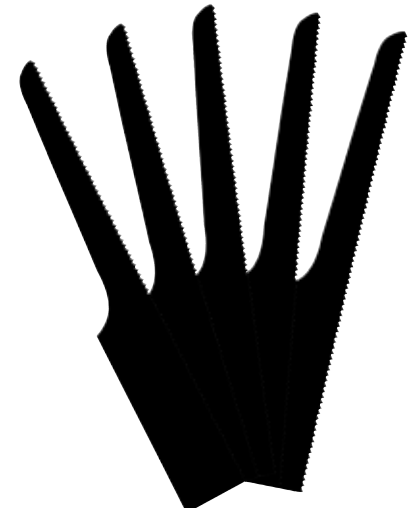

<p>EG26036-7</p>	<p>EG32-1492</p>	<p>EG-BTOB15</p>
<p>Eraser Eagle</p> 	<p>Rubber wheel for EG260S-19R Eagle</p> 	<p>Velcro disk 15 holes Eagle</p> 
<p>EGBT-ADPT</p>	<p>EGBTWW103-235</p>	<p>EGBTWW103-2355</p>
<p>Adapter Eagle</p> 	<p>Wire wheel - fine Eagle</p> 	<p>Wire wheel - medium Eagle</p> 
<p>EGBTWW103-237</p>	<p>EGBT246655</p>	<p>EGSTBT246652</p>
<p>Wire wheel - coarse Eagle</p> 	<p>Rubber wheel Ø 103 mm Eagle</p> 	<p>Nylon wheel Eagle</p> 

POWER TOOLS

AIR TOOLS

TOOL STORAGE

HAND TOOLS

WORKSHOP EQUIPMENT

SPECIALIST VEHICLE TOOLS

<p>EG307008-K02A</p>	<p>EG307008-K02B</p>	<p>EG307008-K02C</p>						
<p>Blade 18 mm Eagle</p>	<p>Blade 36 mm Eagle</p>	<p>Blade 63 mm Eagle</p>						
								
<p>EG307008-K02D</p>	<p>EG307008-K08A</p>	<p>EG307008-K04A</p>						
<p>Blade 90 mm Eagle</p>	<p>Blade 24 mm Eagle</p>	<p>Blade 8 mm Eagle</p>						
								
<p>EG32-1489</p>	<p>EG32-1488</p>	<p>EG1062-2/3</p>						
<p>Spring retainer Eagle</p>	<p>Quick-release retainer chuck Eagle</p>	<p>Velcro disk Eagle</p>						
		 <table border="1" data-bbox="1045 2004 1284 2105"> <thead> <tr> <th></th> <th>Ø pad</th> </tr> </thead> <tbody> <tr> <td>EG1062-2</td> <td>50 mm</td> </tr> <tr> <td>EG1062-3</td> <td>75 mm</td> </tr> </tbody> </table>		Ø pad	EG1062-2	50 mm	EG1062-3	75 mm
	Ø pad							
EG1062-2	50 mm							
EG1062-3	75 mm							

<p>EG307008-K03A</p> <p>Blade 30 mm </p> 	<p>EG307008-K05A</p> <p>Blade 35 mm - straight </p> 	<p>GJS-12</p> <p>Easy-empty dust bag for vacuum quick spiff </p> 
<p>EG307008-K06A</p> <p>Blade 35 mm - serrated </p> 	<p>EG307008-K07A</p> <p>Blade 35 mm - slightly bent </p> 	<p>GJHS-2020</p> <p>Hot Spot blast recovery system </p> 
<p>EG307008-K01A</p> <p>Blade 57 mm </p> 	<p>EG32-1491 Hammer chisel 125 mm, 4pc </p>  <p>EG32-1490 Hammer chisel 175 mm, 5pc </p> 	

POWER TOOLS
 AIR TOOLS
 TOOL STORAGE
 HAND TOOLS
 WORKSHOP EQUIPMENT
 SPECIALIST VEHICLE TOOLS

<p>EG32-1484</p> <p>Jacobs Keyless Chuck 10 mm Eagle</p> 	<p>EG32-1493</p> <p>100mm Cutting disc for EG255A Eagle</p> 	<p>EG954</p> <p>75mm Cutting disc for EG-250-19R Eagle</p> 
<p>EG317043</p> <p>Drill 8 mm (tbv EG317HN and EG327HN) Eagle</p> 	<p>EG317043A</p> <p>Drill 6.5 mm (for EG317HN and EG327HN) Eagle</p> 	<p>EG317043B</p> <p>Drill 10 mm (for EG317HN and EG327HN) Eagle</p> 
<p>EG6062-14</p> <p>Engraving needle for EG6062 Eagle</p> 	<p>EGD001021060</p> <p>50 mm pad for EG1060 + 75mm Eagle</p> 	<p>EG19CF</p> <p>Replacement needle for EG671CF & 672CF Eagle</p> 

IMPACT SOCKETS

EG915 3/8"

3/8" Low profile impact socket set 14pc

- Low profile for use in restricted access areas
- Impact rated
- Cr-Mo phosphate black finish

Contents: 6,7,8,9,10,11,12,13,14,15,16,17,18,19 mm

30% LOWER THAN TRADITIONAL SOCKETS

EG910 1/2"

1/2" Low profile impact socket set 12pc

- Low profile for use in restricted access areas
- Impact rated
- Cr-Mo phosphate black finish

Contents: 10,11,12,13,14,15,16,17,18,19,20,21 mm

30% LOWER THAN TRADITIONAL SOCKETS

U-MET-2300 3/8"

Impact socket set 11pc - MET-2300

Sockets	
Metric (MM)	10 11 12 13 14 15 16 17 18 19 21
Inch (SAE AF)	3/8 7/16 19/32 1/2 9/16 19/32 5/8 11/16 23/32 3/4 13/16
3/8" Impact sockets

U-MET-2400 1/2"

Impact socket set 15pc - MET-2400

Sockets	
Metric (MM)	11 12 13 14 15 16 17 18 19 20
Inch (SAE AF)	7/16 15/32 1/2 9/16 19/32 5/8 11/16 23/32 3/4 25/32
1/2" Impact sockets

Sockets	
Metric (MM)	21 22 23 24 25
Inch (SAE AF)	13/16 7/8 29/32 15/16 1
1/2" Impact sockets

U-MET-2305 3/8"

Deep impact socket set 11pc - MET-2305

Sockets	
Metric (MM)	10 11 12 13 14 15 16 17 18 19 21
Inch (SAE AF)	3/8 7/16 19/32 1/2 9/16 19/32 5/8 11/16 23/32 3/4 13/16
3/8" Deep impact sockets

U-MET-2450 1/2"

Deep impact socket set 15pc - MET-2450

Sockets	
Metric (MM)	11 12 13 14 15 16 17 18 19 20
Inch (SAE AF)	7/16 15/32 1/2 9/16 19/32 5/8 11/16 23/32 3/4 25/32
1/2" Deep impact sockets

Sockets	
Metric (MM)	21 22 23 24 25
Inch (SAE AF)	13/16 7/8 29/32 15/16 1
1/2" Deep impact sockets

POWER TOOLS
AIR TOOLS
TOOL STORAGE
HAND TOOLS
WORKSHOP EQUIPMENT
SPECIALIST VEHICLE TOOLS

SKI3060-SERIE

3/8"

3/8" Impact sockets - 6Pt



	Size (mm)	L (mm)	D1 (mm)	D2 (mm)	W (mm)
SKI3060-006	6	28	11.3	19	3
SKI3060-007	7	28	12.1	19	3.5
SKI3060-008	8	28	13.5	19	4
SKI3060-009	9	28	14.5	19	4
SKI3060-010	10	28	15.8	19	5
SKI3060-011	11	30	17	19	6
SKI3060-012	12	30	18.2	19	6
SKI3060-013	13	30	19.5	22	6
SKI3060-014	14	30	20.8	22	8
SKI3060-016	16	30	23.8	22	8
SKI3060-017	17	32	23.8	22	8
SKI3060-018	18	32	25.8	22	9
SKI3060-019	19	32	27.8	22	9
SKI3060-020	20	32	27.8	22	9
SKI3060-021	21	32	29.8	22	10
SKI3060-022	22	32	31.8	22	10
SKI3060-015	15	30	22	22	10

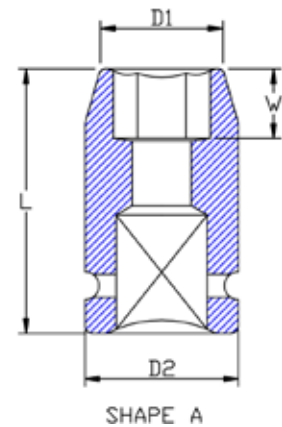

Cr-Mo

MET-23-IMPACT-SOCKET-SERIE

3/8"

3/8" Impact sockets - Metric and Inch



	Size
MET-2310	10 mm - 3/8"
MET-2311	11 mm - 7/16"
MET-2312	12 mm - 15/32"
MET-2313	13 mm - 1/2"
MET-2314	14 mm - 9/16"
MET-2315	15 mm - 19/32"
MET-2316	16 mm - 5/8"
MET-2317	17 mm - 11/16"
MET-2318	18 mm - 23/32"
MET-2319	19 mm - 3/4"
MET-2320	20 mm - 25/32"
MET-2321	21 mm - 13/16"
MET-2322	22 mm - 7/8"



Cr-Mo

SKI3060-L-SERIE

3/8"

3/8" Deep impact sockets - 6Pt



	Size (mm)	L (mm)	D1 (mm)	D2 (mm)	W (mm)
SKI3060-006L	6	63	11.3	19	4
SKI3060-007L	7	63	12.1	19	4
SKI3060-008L	8	63	13.5	19	4
SKI3060-009L	9	63	14.5	19	4
SKI3060-010L	10	63	15.8	19	5
SKI3060-011L	11	63	17	19	6
SKI3060-012L	12	63	18.2	19	6
SKI3060-013L	13	63	19.5	22	6
SKI3060-014L	14	63	20.8	22	8
SKI3060-015L	15	63	22	22	8
SKI3060-016L	16	63	23.8	22	8
SKI3060-017L	17	63	23.8	22	8
SKI3060-018L	18	63	25.8	22	9
SKI3060-019L	19	63	27.8	22	9
SKI3060-020L	20	63	27.8	22	9
SKI3060-021L	21	63	29.8	22	10
SKI3060-022L	22	63	31.8	22	10

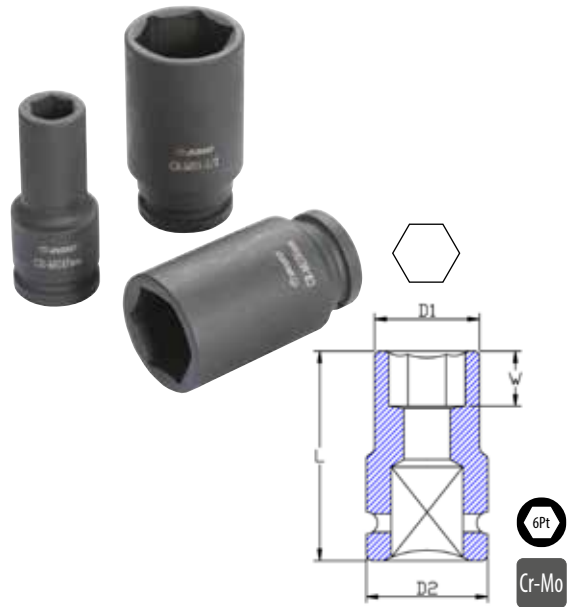

MET-23-DEEP-IMPACT-SOCKET-SERIE

3/8"

3/8" Deep impact sockets - Metric and Inch



	Size
MET-2350	10 mm - 3/8"
MET-2351	11 mm - 7/16"
MET-2352	12 mm - 15/32"
MET-2353	13 mm - 1/2"
MET-2354	14 mm - 9/16"
MET-2355	15 mm - 19/32"
MET-2356	16 mm - 5/8"
MET-2357	17 mm - 11/16"
MET-2358	18 mm - 23/32"
MET-2359	19 mm - 3/4"
MET-2360	20 mm - 25/32"
MET-2361	21 mm - 13/16"
MET-2362	22 mm - 7/8"



SKI3060-E-SERIE

3/8"

3/8" Impact sockets - TX-E



	Size	L (mm)	D1 (mm)	D2 (mm)	W (mm)
SKI3060-005E	E5	30	8.2	19	4
SKI3060-006E	E6	30	9.5	19	5
SKI3060-007E	E7	30	10.3	19	6
SKI3060-008E	E8	30	11.4	19	6
SKI3060-010E	E10	30	12.5	19	7.5
SKI3060-011E	E11	30	13.8	19	8
SKI3060-012E	E12	30	15	19	8.5
SKI3060-014E	E14	30	17	19	10
SKI3060-016E	E16	30	19	19	11

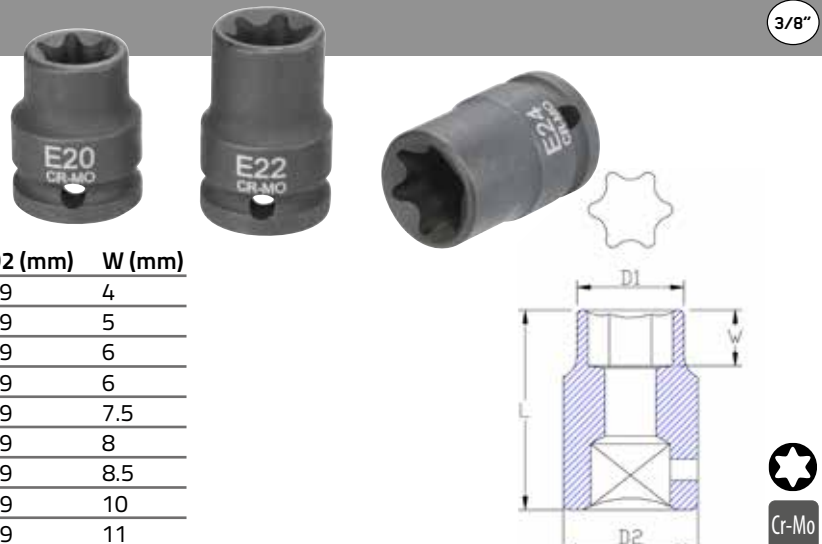

POWER TOOLS

AIR TOOLS

TOOL STORAGE

HAND TOOLS

WORKSHOP EQUIPMENT

SPECIALIST VEHICLE TOOLS

SKI4060-SERIE

1/2"

1/2" Impact sockets - 6Pt



	Size (mm)	L (mm)	D1 (mm)	D2 (mm)	W (mm)
SKI4060-008	8	38	14	25	6
SKI4060-009	9	38	15	25	6
SKI4060-010	10	38	17	25	6
SKI4060-011	11	38	18	25	8
SKI4060-012	12	38	19	25	8
SKI4060-013	13	38	20	25	8
SKI4060-014	14	38	22	25	8
SKI4060-015	15	38	23	30	8
SKI4060-016	16	38	24	30	9
SKI4060-017	17	38	26	30	9
SKI4060-018	18	38	27	30	10
SKI4060-019	19	38	28	30	10
SKI4060-020	20	38	29	30	12
SKI4060-021	21	38	30	30	12
SKI4060-022	22	38	31.8	30	12
SKI4060-023	23	38	30	31.8	14
SKI4060-024	24	38	33.8	30	14
SKI4060-025	25	40	35	30	14
SKI4060-026	26	43	35.8	30	14
SKI4060-027	27	43	37.8	30	14
SKI4060-028	28	43	39.8	30	16
SKI4060-029	29	43	39.8	30	16
SKI4060-030	30	43	41.8	30	16
SKI4060-032	32	43	43.8	30	18

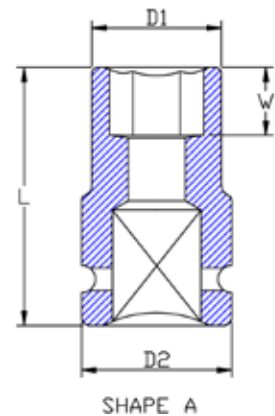

6Pt
Cr-Mo

MET-22-IMPACT-SOCKET-SERIE

1/2"

1/2" Impact sockets - Metric and Inch



	Size
MET-2210	10 mm - 3/8"
MET-2211	11 mm - 7/16"
MET-2212	12 mm - 15/32"
MET-2213	13 mm - 1/2"
MET-2214	14 mm - 9/16"
MET-2215	15 mm - 19/32"
MET-2216	16 mm - 5/8"
MET-2217	17 mm - 11/16"
MET-2218	18 mm - 23/32"
MET-2219	19 mm - 3/4"
MET-2220	20 mm - 25/32"
MET-2221	21 mm - 13/16"
MET-2222	22 mm - 7/8"
MET-2223	23 mm - 29/32"
MET-2224	24 mm - 15/16"
MET-2225	25 mm - 1"
MET-2227	27 mm - 1 1/16"
MET-2228	28 mm - 1 1/8"
MET-2230	29/30 mm - 1 3/16"
MET-2232	31/32 mm - 1 1/4"



Cr-Mo

SKI4060-L-SERIE

1/2"

1/2" Deep impact sockets - 6Pt



	Size (mm)	L (mm)	D1 (mm)	D2 (mm)	W (mm)
SKI4060-008L	8	78	14	25	12
SKI4060-009L	9	78	15	25	12
SKI4060-010L	10	78	17	25	12
SKI4060-011L	11	78	18	25	13
SKI4060-012L	12	78	19	25	14
SKI4060-013L	13	78	20	25	14
SKI4060-014L	14	78	22	25	14
SKI4060-015L	15	78	23	30	16
SKI4060-016L	16	78	24	30	16
SKI4060-017L	17	78	26	30	17
SKI4060-018L	18	78	27	30	18
SKI4060-019L	19	78	28	30	20
SKI4060-020L	20	78	29	30	20
SKI4060-021L	20	78	30	30	22
SKI4060-022L	22	78	31.8	30	22
SKI4060-023L	23	78	31.8	30	24
SKI4060-024L	24	78	33.8	30	24
SKI4060-025L	25	78	35	30	24
SKI4060-026L	26	78	35.8	30	27
SKI4060-027L	27	78	37.8	30	27
SKI4060-028L	28	78	39.8	30	27
SKI4060-029L	29	78	39.8	30	27
SKI4060-030L	30	78	41.8	30	30
SKI4060-032L	32	78	43.8	30	32



6Pt

Cr-Mo

MET-22-DEEP-IMPACT-SOCKET-SERIE

1/2"

1/2" Deep impact sockets - Metric and Inch



	Size
MET-2250	10 mm - 3/8"
MET-2251	11 mm - 7/16"
MET-2252	12 mm - 15/32"
MET-2253	13 mm - 1/2"
MET-2254	14 mm - 9/16"
MET-2255	15 mm - 19/32"
MET-2256	16 mm - 5/8"
MET-2257	17 mm - 11/16"
MET-2258	18 mm - 23/32"
MET-2259	19 mm - 3/4"
MET-2260	20 mm - 25/32"
MET-2261	21 mm - 13/16"
MET-2262	22 mm - 7/8"
MET-2263	23 mm - 29/32"
MET-2264	24 mm - 15/16"
MET-2265	25 mm - 1"
MET-2267	27 mm - 1 1/16"
MET-2268	28 mm - 1 1/8"
MET-2270	29/30 mm - 1 3/16"
MET-2272	31/32 mm - 1 1/4"



6Pt

Cr-Mo

POWER TOOLS

AIR TOOLS

TOOL STORAGE

HAND TOOLS

WORKSHOP EQUIPMENT

SPECIALIST VEHICLE TOOLS

SKI4060-E-SERIE

1/2"

1/2" Impact sockets - TX-E



	Size	L (mm)	D1 (mm)	D2 (mm)	W (mm)
SKI4060-010E	E10	38	14.2	25	7.5
SKI4060-011E	E11	38	15	25	8
SKI4060-012E	E12	38	16	25	8.5
SKI4060-014E	E14	38	18	25	10
SKI4060-016E	E16	38	20	25	11
SKI4060-018E	E18	38	22	25	12
SKI4060-020E	E20	38	24	30	14
SKI4060-022E	E22	45	25.5	30	16
SKI4060-024E	E24	45	28	30	18

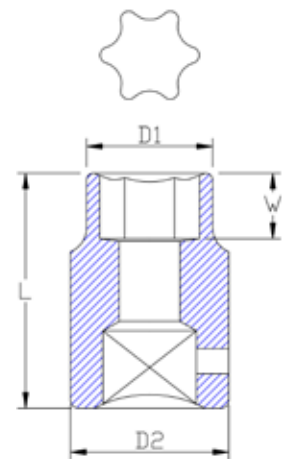

Cr-Mo

HBI4600T-SERIE

1/2"

1/2" TX Impact sockets



	L (mm)	D2 (mm)
HBI4600T-020	77	25
HBI4600T-025	77	25
HBI4600T-027	77	25
HBI4600T-030	77	25
HBI4600T-040	77	25
HBI4600T-045	77	25
HBI4600T-050	77	25
HBI4600T-055	77	25
HBI4600T-060	77	25
HBI4600T-070	77	25

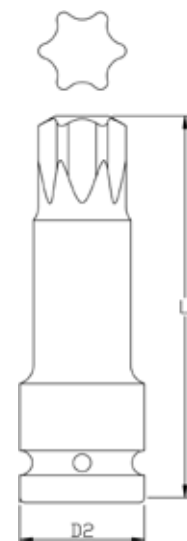

Cr-Mo

HBI4678M-SERIE

1/2"

1/2" Impact sockets - Spline (XZN)



	Size
HBI4678M-014	M14
HBI4678M-016	M16
HBI4678M-018	M18



POWER TOOLS

AIR TOOLS

HBI4600H-SERIE

1/2"

1/2" Impact sockets - Hex



	Size (mm)	L (mm)	D2 (mm)
HBI4600H-004	4	78	25
HBI4600H-005	5	78	25
HBI4600H-006	6	78	25
HBI4600H-007	7	78	25
HBI4600H-008	8	78	25
HBI4600H-009	9	78	25
HBI4600H-010	10	78	25
HBI4600H-011	11	78	25
HBI4600H-012	12	78	25
HBI4600H-013	13	78	25
HBI4600H-014	14	78	25
HBI4600H-015	15	78	25
HBI4600H-016	16	78	25
HBI4600H-017	17	78	25
HBI4600H-018	18	78	25
HBI4600H-019	19	78	25



TOOL STORAGE

HAND TOOLS

SKIN406A-SERIE

1/2"

1/2" Alloy wheel impact sockets - 6 Pt



**30% LONGER LIFE
THAN COMPARABLE
COMPETITIVE
PRODUCTS**

	Size (mm)
SKIN406A-15	15
SKIN406A-17	17
SKIN406A-19	19
SKIN406A-21	21
SKIN406A-22	22



WORKSHOP EQUIPMENT

SPECIALIST VEHICLE TOOLS

SKI6060-SERIE

3/4"

3/4" Impact sockets - 6Pt



	Size (mm)	L (mm)	D1 (mm)	D2 (mm)	W (mm)
SKI6060-019	19	52	30	38	9
SKI6060-021	21	52	32	38	11
SKI6060-022	22	52	34	38	14
SKI6060-024	24	52	36	38	14
SKI6060-027	27	52	40	40	14
SKI6060-028	28	52	42	42	15
SKI6060-030	30	52	44	44	15
SKI6060-032	32	52	46	44	15
SKI6060-033	33	56	48	44	18
SKI6060-034	34	56	48	44	18
SKI6060-036	36	56	52	44	18

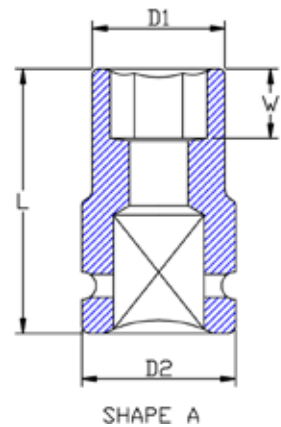

SKI6060-L-SERIE

3/4"

3/4" Deep impact sockets - 6Pt



	Size (mm)	L (mm)	D1 (mm)	D2 (mm)	W (mm)
SKI6060-019L	19	90	30	38	12
SKI6060-021L	21	90	32	38	12
SKI6060-022L	22	90	34	38	19
SKI6060-024L	24	90	36	38	19
SKI6060-027L	27	90	40	40	19
SKI6060-028L	28	90	42	42	19
SKI6060-030L	30	90	44	44	19
SKI6060-032L	32	90	46	44	19
SKI6060-033L	33	90	48	44	19
SKI6060-034L	34	90	48	44	19
SKI6060-036L	36	90	52	44	19

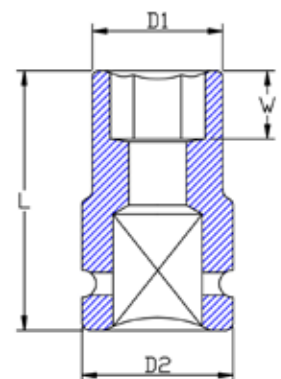

1" IMPACT SOCKETS

SKI8060-SERIE

1"

1" Impact sockets - 6Pt



	Size (mm)	L (mm)	D1 (mm)	D2 (mm)	W (mm)
SKI8060-024	24	58	40	51	14
SKI8060-027	27	58	44	51	14
SKI8060-030	30	60	48	51	16
SKI8060-032	32	60	51	51	19
SKI8060-033	33	62	53	52	19
SKI8060-034	34	62	54	52	19
SKI8060-036	36	62	56	52	19
SKI8060-041	41	62	61.5	52	23
SKI8060-046	46	64	68	58	23
SKI8060-050	50	70	73	58	26
SKI8060-055	55	72	79	62	28
SKI8060-060	60	78	87	62	31

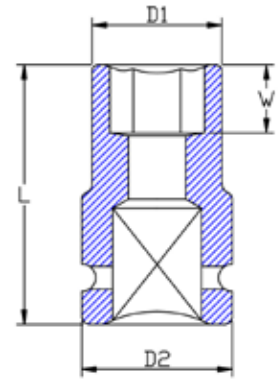

POWER TOOLS

AIR TOOLS

TOOL STORAGE

SKI8060-L-SERIE

1"

1" Deep impact sockets - 6 Pt



	Size (mm)	L (mm)	D1 (mm)	D2 (mm)	W (mm)
SKI8060-024L	24	90	40.5	51	16
SKI8060-027L	27	90	44	51	19
SKI8060-030L	30	90	48	51	19
SKI8060-032L	32	90	51	51	19
SKI8060-033L	33	90	53	52	23
SKI8060-036L	36	90	56	52	23
SKI8060-041L	41	92	61.5	52	40
SKI8060-046L	46	92	68	58	40

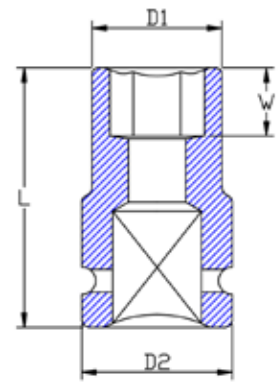

HAND TOOLS

WORKSHOP EQUIPMENT

SPECIALIST VEHICLE TOOLS

ADI-SERIE

1/4" 3/8" 1/2" 3/4" 1"

1/4"x3/8" Impact adapter 26 mm



	Size	L (mm)	D2 (mm)
ADI2030-001	1/4"x3/8"	26	13
ADI3020-001	3/8"x1/4"	32	22
ADI3040-001	3/8"x1/2"	36	22
ADI4030-001	1/2"x3/8"	38	25
ADI4060-001	1/2"x3/4"	48	30
ADI6040-001	3/4"x1/2"	56	44
ADI6080-001	3/4"x1"	63	44
ADI8060-001	1"x3/4"	75	54

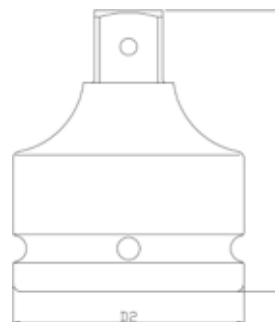

Steel ball retainer

Cr-Mo

EXI-SERIE

1/4" 3/8" 1/2" 3/4" 1"

Impact extension bars



	Size	L (mm)	D1 (mm)
EXI20050-001	1/4"	50	13
EXI20100-001	1/4"	100	13
EXI20150-001	1/4"	150	13
EXI30075-001	3/8"	75	19
EXI30150-001	3/8"	150	19
EXI30250-001	3/8"	250	19
EXI40075-001	1/2"	75	25
EXI40125-001	1/2"	125	25
EXI40200-001	1/2"	200	25
EXI40250-001	1/2"	250	25
EXI60100-001	3/4"	100	44
EXI60150-001	3/4"	150	44
EXI60175-001	3/4"	175	44
EXI60200-001	3/4"	200	44
EXI60250-001	3/4"	250	44
EXI60330-001	3/4"	330	44
EXI60400-001	3/4"	400	44
EXI80100-001	1"	100	54
EXI80175-001	1"	175	54
EXI80200-001	1"	200	54
EXI80250-001	1"	250	54
EXI80330-001	1"	330	54
EXI80400-001	1"	400	54



Steel ball retainer

Cr-Mo

UJI-SERIE

1/4" 3/8" 1/2" 3/4" 1"

Impact universal joints



	Size	L (mm)	D2 (mm)
UJI2300-001	1/4"	37	16
UJI3300-001	3/8"	51	24
UJI4300-001	1/2"	63	28
UJI6300-001	3/4"	90	44
UJI8300-001	1"	110	54



Steel ball retainer

Cr-Mo



POWER TOOLS

AIR TOOLS



TOOL STORAGE

HAND TOOLS



WORKSHOP EQUIPMENT

SPECIALIST VEHICLE TOOLS

TOOL STORAGE











Boxo the name for quality tool storage systems developed for the professional automotive and industrial markets. Benefitting from over 40 years of experience in these industries manufacturing high quality tool storage systems. We focus on product research, design, durability, quality control with a real life testing facility. The creators of Boxo have developed this program of tool storage systems to suit all modern day requirements. Boxo continually works on product and service improvement. All Boxo products have been manufactured to meet or exceed international standards.

'Boxo, The choice for the professional!
Satisfaction guaranteed!'

SYMBOL GUIDE

 6-point	 TX = TORX male	
 72 teeth	 SL = Slotted	
 HX = HEX male	 PH = Philips	

SUB-SECTIONS

- 64** TOOL TROLLEYS
- 73** PARTS
- 74** ACCESSORIES
- 76** PARTS
- 78** TOP AND SIDE CHESTS
- 80** WORK BANCHES
- 82** OSM
- 94** DRAWER DIVIDERS
- 96** OSM
- 102** CARRY BOXES
- 104** PRE-CHOSEN TOOL-SYSTEM-MODULES

BTD270071M-G

7 Drawer racing trolley with MIS system, black-gray
678x459x1000 mm

- MIS system: Antitip mechanism, only one drawer opens at one time
- Powder coating to resist scratch & solvent markings
- Auto returning ball bearing slider for smooth opening and closing
- ABS drawer handle
- 4 x 5" PVC Casters (2 with brake)
- Soft foam top tray
- Lock & key
- Steel handle

Dimensions (WxDxH):
Overall: 681x459x1000 mm
5 Drawer: 569x397x75 mm
2 Drawer: 569x397x154 mm



Drawers	7
Drawer capacity	35 kg
Foam capacity	7 x 3
Trolley capacity	700 kg
Weight	56 kg



BTD340071M-G

7 Drawer XL trolley with MIS system, black-gray

- MIS system: Antitip mechanism, only one drawer opens at one time
- Powder coating to resist scratch & solvent markings
- Auto returning ball bearing slider for smooth opening and closing
- ABS drawer handle
- 4 x 5" PVC Casters (2 with brake)
- Soft foam top tray
- Lock & key
- Steel handle

Dimensions (WxDxH):
Overall: 863x459x1000 mm
5 Drawer: 753x397x75 mm
2 Drawer: 753x397x154 mm



Drawers	7
Drawer capacity	35 kg
Foam capacity	7 x 4
Trolley capacity	700 kg
Weight	64.5 kg





POWER TOOLS

AIR TOOLS

TOOL STORAGE

AT7072M-G

7 drawer trolley with mis system and digit lock, black-gray

- MIS system: Antitip mechanism, only one drawer opens at one time
- Powder coating to resist scratch & solvent markings
- Auto returning ball bearing slider for smooth opening and closing
- 4 x 5" TPR Casters (2 with swivel and brake)
- ABS top tray
- Lock & key
- Steel handle with soft grip
- Can holder
- Paper holder



HAND TOOLS

WORKSHOP EQUIPMENT

SPECIALIST VEHICLE TOOLS



Dimensions (WxDxH):
Overall: 863x459x1000 mm
5 Drawer: 753x397x75 mm
2 Drawer: 753x397x154 mm



Drawers	7
Drawer capacity	45 kg
Foam capacity	7 x 3
Trolley capacity	700 kg
Weight	67 kg



MAA003 Can holder



MAA008 – Paper holder

OPTIONAL ACCESSORIES



B002 – Folding shelf
To create extra workspace on the trolley

AT7051M-G

5 Drawer trolley with MIS system, black-gray

- MIS system: Antitip mechanism, only one drawer opens at one time
- Powder coating to resist scratch & solvent markings
- Auto returning ball bearing slider for smooth opening and closing
- Drawer capacity: 45 kgs per drawer
- 4x5" TPR Casters (2 with swivel and brake)
- ABS top tray
- Lock & key
- Steel handle with soft grip
- Can holder
- Paper holder



Drawers	5
Drawer capacity	45 kg
Foam capacity	5 x 3
Trolley capacity	700 kg
Width	681 mm
Weight	66 kg

Dimensions (WxDxH):
 Overall: 681x459x1000 mm
 1 Drawer: 569x397x75 mm
 4 Drawer: 569x397x154 mm



MAA003 Can holder



MAA008 - Paper holder

OPTIONAL ACCESSORIES



B002 - Folding shelf

To create extra workspace on the trolley

AT7071M-SERIE

7 Drawer trolley with MIS-system - 681x459x1000 mm

- MIS system: Antitip mechanism, only one drawer opens at one time
- Powder coating to resist scratch & solvent markings
- Auto returning ball bearing slider for smooth opening and closing
- 4 x 5" TPR Casters (2 with swivel and brake)
- ABS top tray
- Lock & key
- Steel handle with soft grip
- Can holder
- Paper holder



-R

-B



Drawers	7
Drawer capacity	45 kg
Foam capacity	7 x 3
Trolley capacity	700 kg
Weight	67 kg

Dimensions (WxDxH):
 Overall: 681x459x1000 mm
 5 Drawer: 569x397x75 mm
 2 Drawer: 569x397x154 mm



MAA003 Can holder



MAA008 - Paper holder

OPTIONAL ACCESSORIES



B002 - Folding shelf

To create extra workspace on the trolley

AT7081M-G

8 Drawer trolley with MIS system, black-gray

- MIS system: Antitip mechanism, only one drawer opens at one time
- Powder coating to resist scratch & solvent markings
- Auto returning ball bearing slider for smooth opening and closing
- 4x5" TPR Casters (2 with swivel and brake)
- ABS top tray
- Lock & key
- Steel handle with soft grip
- Can holder
- Paper holder



Drawers	8
Drawer capacity	45 kg
Foam capacity	8 x 3
Trolley capacity	700 kg
Width	681 mm
Weight	72 kg

Dimensions (WxDxH):
Overall: 681x459x1000 mm
7 Drawer: 569x397x75 mm
1 Drawer: 569x397x154 mm



MAA003 Can holder



MAA008 – Paper holder

OPTIONAL ACCESSORIES



B002 – Folding shelf

To create extra workspace on the trolley

AT7091M-G

9 Drawer trolley with MIS system, black-gray

- MIS system: Antitip mechanism, only one drawer opens at one time
- Powder coating to resist scratch & solvent markings
- Auto returning ball bearing slider for smooth opening and closing
- 4x5" TPR Casters (2 with swivel and brake)
- ABS top tray
- Lock & key
- Steel handle with soft grip
- Can holder
- Paper holder



Drawers	9
Drawer capacity	45 kg
Foam capacity	9 x 3
Trolley capacity	700 kg
Width	681 mm
Weight	72 kg

Dimensions (WxDxH):
Overall: 681x459x1000 mm
9 Drawer: 569x397x75 mm
2 Drawer: 569x397x154 mm



MAA003 Can holder



MAA008 – Paper holder

OPTIONAL ACCESSORIES



B002 – Folding shelf

To create extra workspace on the trolley

ATB30051M-G

5 Drawer trolley with MIS system, black-gray - 724x459x1000 mm

- MIS system: Antitip mechanism, only one drawer opens at one time
- Powder coating to resist scratch & solvent markings
- Auto returning ball bearing slider for smooth opening and closing
- 4x5" TPR Casters (2 with swivel and brake)
- ABS top tray and large side handle with rubber feel for added comfort
- Lock & key
- Bumper on corners to prevent damage to "vehicles" or machines
- Can holder
- Paper holder



Drawers	5
Drawer capacity	45 kg
Foam capacity	5 x 3
Trolley capacity	700 kg
Width	724 mm
Weight	68.7 kg



MAA003
Can holder



MAA008
Paper holder

Dimensions (WxDxH):
Overall: 724x459x1000 mm
1 Drawer: 569x397x75 mm
4 Drawer: 569x397x154 mm



ATB30071M-SERIE

7 Drawer trolley with MIS system, black-gray - 724x459x1000 mm

- MIS system: Antitip mechanism, only one drawer opens at one time
- Powder coating to resist scratch & solvent markings
- Auto returning ball bearing slider for smooth opening and closing
- 4x5" TPR Casters (2 with swivel and brake)
- ABS top tray and large side handle with rubber feel for added comfort
- Lock & key
- Bumper on corners to prevent damage to "vehicles" or machines
- Can holder
- Paper holder



-R

-B



Drawers	7
Drawer capacity	45 kg
Drawer dimensions	569x397x75 / 154 mm
Foam capacity	7 x 3
Trolley capacity	700 kg
Width	724 mm
Weight	68 kg



MAA003
Can holder



MAA008
Paper holder



Dimensions (WxDxH):
Overall: 724x459x1000 mm
5 Drawer: 569x397x75 mm
2 Drawer: 569x397x154 mm



ATB30081M-G

8 Drawer trolley with MIS system, black-gray -
724x459x1000 mm

- MIS system: Antitip mechanism, only one drawer opens at one time
- Powder coating to resist scratch & solvent markings
- Auto returning ball bearing slider for smooth opening and closing
- 4x5" TPR Casters (2 with swivel and brake)
- ABS top tray and large side handle with rubber feel for added comfort
- Lock & key
- Bumper on corners to prevent damage to "vehicles" or machines
- Can holder
- Paper holder



Drawers	8
Drawer capacity	45 kg
Foam capacity	8 x 3
Trolley capacity	700 kg
Width	724 mm
Weight	68 kg



MAA003
Can holder



MAA008
Paper holder

Dimensions (WxDxH):
Overall: 724x459x1000 mm
7 Drawer: 569x397x75 mm
1 Drawer: 569x397x154 mm



POWER TOOLS

AIR TOOLS

TOOL STORAGE

ATB30091M-G

9 Drawer trolley with MIS system, black-gray -
724x459x1000 mm

- MIS system: Antitip mechanism, only one drawer opens at one time
- Powder coating to resist scratch & solvent markings
- Auto returning ball bearing slider for smooth opening and closing
- 4x5" TPR Casters (2 with swivel and brake)
- ABS top tray and large side handle with rubber feel for added comfort
- Lock & key
- Bumper on corners to prevent damage to "vehicles" or machines
- Can holder
- Paper holder



Drawers	9
Drawer capacity	45 kg
Foam capacity	9 x 3
Trolley capacity	700 kg
Width	724 mm
Weight	68 kg



MAA003
Can holder



MAA008
Paper holder

Dimensions (WxDxH):
Overall: 724x459x1000 mm
9 Drawer: 569x397x75 mm



HAND TOOLS

WORKSHOP EQUIPMENT

SPECIALIST VEHICLE TOOLS



ATB37071M-B

7 Drawer trolley with MIS system, blue - 915x459x1000 mm

- MIS system: Antitip mechanism, only one drawer opens at one time
- Powder coating to resist scratch & solvent markings
- Auto returning ball bearing slider for smooth opening and closing
- 4x 5" TPR Casters (2 with swivel and brake)
- PVC top tray with large side handle with rubber feel for added comfort
- Lock & key
- Bumper on corners to prevent damage to "vehicles" or machines
- Can holder
- Paper holder

Top Chest available - ACB37041M-B



Drawers	7
Drawer capacity	45 kg
Foam capacity	7 x 4
Trolley capacity	700 kg
Width	915 mm
Weight	80 kg

Dimensions (WxDxH):
 Overall: 915x459x1000 mm
 5 Drawer: 753x397x75 mm
 2 Drawer: 753x397x154 mm



MAA003
Can holder



MAA008
Paper holder

ATB37081M-B

8 Drawer trolley with MIS system, blue - 915x459x1000 mm

- MIS system: Antitip mechanism, only one drawer opens at one time
- Powder coating to resist scratch & solvent markings
- Auto returning ball bearing slider for smooth opening and closing
- 4x 5" TPR Casters (2 with swivel and brake)
- PVC top tray with large side handle with rubber feel for added comfort
- Lock & key
- Bumper on corners to prevent damage to "vehicles" or machines
- Can holder
- Paper holder



Drawers	8
Drawer capacity	45 kg
Foam capacity	8 x 4
Trolley capacity	700 kg
Width	915 mm
Weight	88 kg

Dimensions (WxDxH):
Overall: 915x459x1000 mm
7 Drawer: 753x397x75 mm
1 Drawer: 753x397x154 mm



MAA003
Can holder



MAA008
Paper holder

ATB7450141M-B

14 Drawer trolley with MIS system, blue - 1180x459x1000 mm

- MIS system: Antitip mechanism, only one drawer opens at one time
- Powder coating to resist scratch & solvent markings
- Auto returning ball bearing slider for smooth opening and closing
- 4x 5" PU Casters (2 with swivel and brake)
- PVC top tray with large side handle
- Lock & key
- Bumper on corners to prevent damage to "vehicles" or machines
- Can holder
- Paper holder



Top chest available - ACB745081M-B



Drawers	14
Drawer capacity	45 kg
Foam capacity	7 x 3, 7 x 2
Trolley capacity	1000 kg
Width	1180 mm
Weight	118 kg

Dimensions (WxDxH):
Overall: 1180x459x1000 mm
5 Drawer: 569x397x75 mm
2 Drawer: 569x397x154 mm
5 Drawer: 376x397x75 mm
2 Drawer: 376x397x154 mm



MAA003
Can holder



MAA008
Paper holder

POWER TOOLS

AIR TOOLS

TOOL STORAGE

HAND TOOLS

WORKSHOP EQUIPMENT

SPECIALIST VEHICLE TOOLS

ATR450131CL-B

12 Drawer trolley with MIS system, blue - 1160x716x1000 mm

- MIS system: Antitip mechanism, only one drawer opens at one time
- Powder coating to resist scratch & solvent markings
- Auto returning ball bearing slider for smooth opening and closing
- 4 x 5" PU Casters (2 with swivel and brake)
- Hard PVC top tray and large side handle
- Can holder
- Paper holder
- Lock & key

MAA008
Paper holder



Drawers	12
Drawer capacity	45 kg
Foam capacity	7 x 3 - 5 x 3
Trolley capacity	1000 kg
Width	1160 mm
Weight	156 kg

Dimensions (WxDxH):
Overall: 1160x716x1000 mm
5 Drawer: 569x397x75 mm
2 Drawer: 569x397x154 mm

Dimensions side (WxDxH):
1 Drawer: 569x397x75 mm
4 Drawer: 569x397x154 mm



ATR450131CL-BW

12 Drawer trolley with MIS system and wooden top, blue - 1160x716x1000 mm

- MIS system: Antitip mechanism, only one drawer opens at one time
- Powder coating to resist scratch & solvent markings
- Auto returning ball bearing slider for smooth opening and closing
- 4 x 5" PU Casters (2 with swivel and brake)
- Hard PVC top tray and large side handle
- Can holder
- Paper holder
- Lock & key



MAA008
Paper holder



Color	Blue
Drawers	12
Drawer capacity	45 kg
Foam capacity	7 x 3 - 5 x 3
Trolley capacity	1000 kg
Width	1160 mm
Weight	156 kg

Dimensions (WxDxH):
Overall: 1160x716x1000 mm
5 Drawer: 569x397x75 mm
2 Drawer: 569x397x154 mm

Dimensions side (WxDxH):
1 Drawer: 569x397x75 mm
4 Drawer: 569x397x154 mm



PARTS

D-ATB-330M-75H

Empty drawer ATB 75H (ATB745 2 FOAM)



Weight 4 kg

D-ATB-75H

Drawer 75 mm high



D-ATB-330M-154

Empty drawer ATB 154H (ATB745 2 FOAM)



Weight 4.95 kg

D-ATB-154H

Drawer 154 mm high



D-ATB753M-75H

Empty drawer ATB37071M-B - 75H



Weight 5 kg

D-ATB753M-154H

Empty drawer ATB37071M-B - 154H



Weight 6 kg

D-ATB-75H

Empty drawer OSM MST - 75H



D-ATB-154H

Empty drawer OSM MST - 154H



POWER TOOLS

AIR TOOLS

TOOL STORAGE

HAND TOOLS

WORKSHOP EQUIPMENT

SPECIALIST VEHICLE TOOLS

AA021S

Document holder for AT-serie



MAA021

Document holder for ATB-serie and OSM



B002

Folding shelf



To create extra workspace on the trolley



MAA025

Laptop holder for ATB-serie

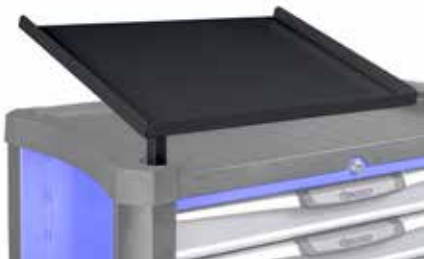

MAA008

Paper holder



For tool trolleys and OSM



MAA003

Can holder



For tool trolleys and OSM



MAA011A

Holder for impact wrenches



For tool trolleys and OSM

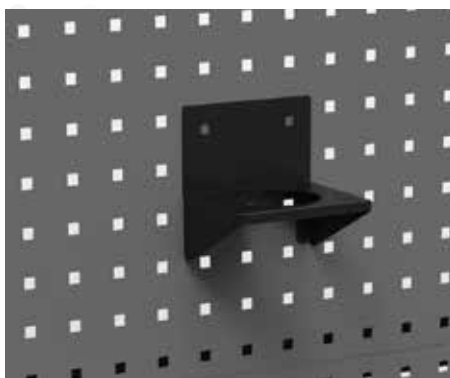

MAA034

Impact socket holder



For tool trolleys and OSM

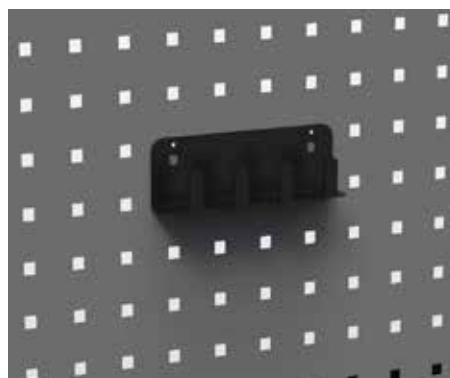

13-16l

Ball bearing slider 2pc for trolleys



P-TDH-20

Double pen tool hanger 50 mm



P-TSH-20

Single pen tool hanger 50 mm



P-TDH-40

Double pen tool hanger 95 mm



P-TSH-40

Single pen tool hanger 95 mm



Z007-KEY

Single key without profile 2pc



BXZ11-04

Lock & Key for BTD-serie



P-KEYLOCK-C-N1

Key & lock for OSM trolley cabinet No.



Key & lock for OSM drawer cabinet MST340071



POWER TOOLS

AIR TOOLS

TOOL STORAGE

HAND TOOLS

WORKSHOP EQUIPMENT

SPECIALIST VEHICLE TOOLS

P-52PS

5" Swivel caster TPR with brake 1pc



P-52PUS

5" Swivel caster PU with brake 1pc



BXZ11-03S

5" Swivel caster PVC for BTD-series 1PC



P-52TF

5" Caster TPR 1pc



P-52PUF

5" Caster PU 1pc



BXZ11-03

5" Caster PVC for BTD-series 1PC



BXZ11-02

Ball bearing slider for BTD-serie 2pc



P-TOPMA-AT70

Top mat for AT7071M



P-TOPTR-AT70

Top tray for AT7071M



P-TOPTR-ATB30

Top tray for ATB30071M-SERIE



P-TOPPV-ATB37

Top PVC for ATB37071M



P-TOPPV-ATB45

Top PVC for ATB7450141M & ATB7452071M



P-TOPPV-ATR45

Top PVC for ATR450131CL-B



P-TOPWO-ATR45

Wooden worktop for ATR450131CL-BW



Wooden worktop for ATR-series



POWER TOOLS

AIR TOOLS

TOOL STORAGE

HAND TOOLS

WORKSHOP EQUIPMENT

SPECIALIST VEHICLE TOOLS

ACB30041M-SERIE

4 Drawer top chest with MIS-System for ATB37071M

- MIS system: Antitip mechanism, only one drawer opens at one time
- Powder coating to resist scratch & solvent markings
- Auto returning ball bearing slider for smooth opening and closing
- Side carry handles with soft grip & top mat
- Bumper on corners to prevent damage to "vehicles" or machines
- Lock & key



Drawers	4
Drawer capacity	45 kg
Foam capacity	4 x 3
Weight	43 kg



Dimensions (WxDxH)
Overall: 724x459x403 mm



Specially designed as top chest for ATB-Series tool boxes



ACB37041M-B

4 Drawer top chest with MIS-System for ATB37071M-B blue

- MIS system: Antitip mechanism, only one drawer opens at one time
- Powder coating to resist scratch & solvent markings
- Auto returning ball bearing slider for smooth opening and closing
- Side carry handles with soft grip & top mat
- Bumper on corners to prevent damage to "vehicles" or machines
- Lock & key



Drawers	8
Drawer capacity	45 kg
Foam capacity	4 x 4
Weight	43 kg



Dimensions (WxDxH)
Overall: 915x459x403 mm



Specially designed as top chest for ATB37071M-B tool boxes



ACB745081M-B

8 Drawer top chest with MIS-System for ATB37071M-B blue

- MIS system: Antitip mechanism, only one drawer opens at one time
- Powder coating to resist scratch & solvent markings
- Auto returning ball bearing slider for smooth opening and closing
- Drawer capacity: 45 kgs per drawer
- Side carry handles with soft grip & top mat
- Bumper on corners to prevent damage to "vehicles" or machines
- Lock & key



Drawers	8
Drawer capacity	45 kg
Foam capacity	4 x 3 - 4 x 2
Weight	85 kg



Dimensions (WxDxH)
Overall: 1180x459x403 mm

Specially designed as top chest for ATB7450141M-B tool boxes



BSD-283000-RB

Heavy duty service cart Black / Red

- Powder-coated, scratch and solvent resistant finish
- Steel side handle
- High performance casters with brake system



Trays	3
Weight capacity (total)	150 kgs
Weight	13 kg

TB-ECC30030-SERIE

Heavy-duty service carts

- Powder-coated, scratch and solvent resistant finish
- Steel side handle
- High performance casters with brake system



Colour options	● ● ●
Trays	3
Weight capacity (total)	240 kgs
Weight	15 kg

Dimensions (WxDxH)
Overall: 702x491x832 mm

POWER TOOLS

AIR TOOLS

TOOL STORAGE

HAND TOOLS

WORKSHOP EQUIPMENT

SPECIALIST VEHICLE TOOLS

F6201

Bracket



AC92333-B

3 Drawer middle chest

- Powder coating to resist scratch & solvent markings
- Auto returning ball bearing slider for smooth opening and closing
- Side carry handles with soft grip
- Top mat
- Lock & key

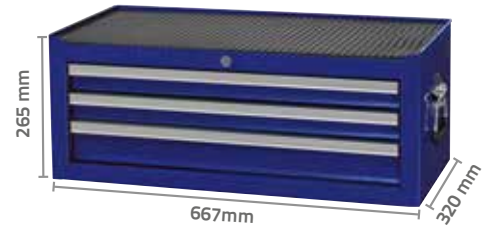

Drawers	3
Drawer capacity	30 kg
Length	313 mm
Width	668 mm
Weight	18.3 mm

AW6201A

Perforated panel

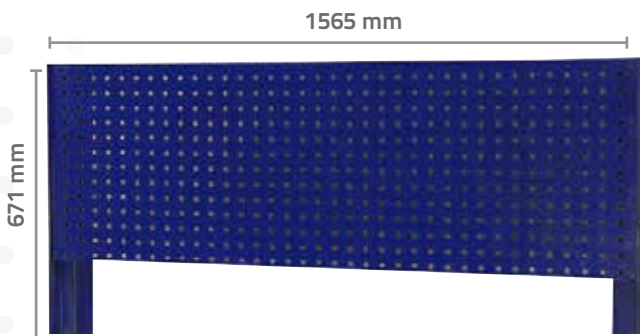

AB6200

Wall storage system with shutter



AW6201

Work bench

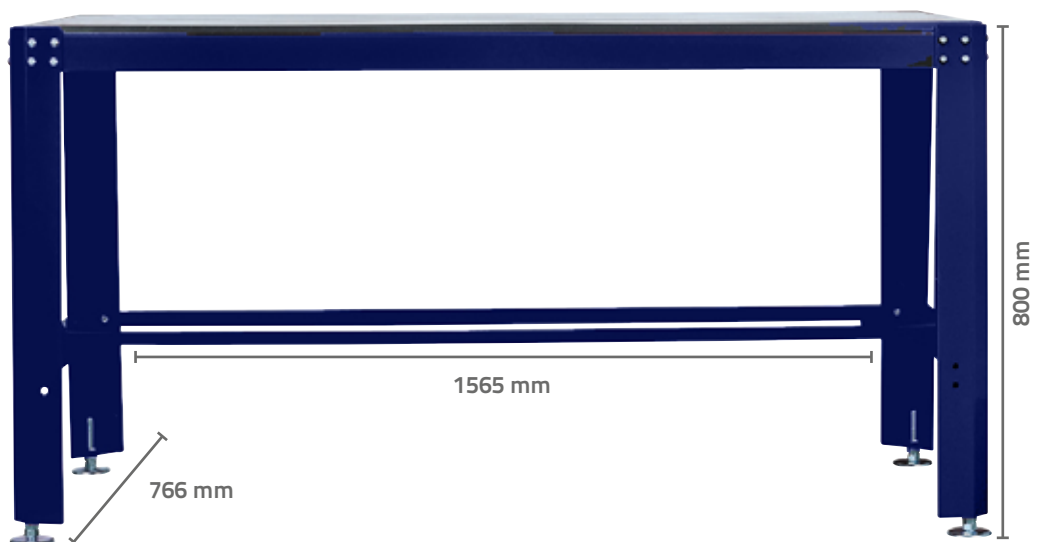

AW6201 + AW6201A + AC92333-B + F6201

Work bench



AW6201 + AB6200 + AC92333-B + F6201

Work bench



POWER TOOLS

AIR TOOLS

TOOL STORAGE

HAND TOOLS

WORKSHOP EQUIPMENT

SPECIALIST VEHICLE TOOLS

OSM

Combination type for Organized Storage Modules

With OSM you can design your own storage system, all parts can be ordered individually. We have prepared a wide range of parts for you to choose. It is the ultimate storage solution which improves your productivity and efficiency for work. Below is several types for your reference. You can always design your unique style.

Colour combination is Black/Gray (Gray is RAL7005 / Black is RAL9017)



Full-extension drawers



Heavy duty ball bearing sliders



Wall cabinet with 3 shelves
- 2 adjustable shelves



One key system



Closet with adjustable shelf

 **BOXO**
tools for life



Cupboard with gas strut



Perforated panel for tool hook (9x9)



CREATE YOUR OWN WORKSPACE!
WWW.BOXO.TOOLS



Portable trolley 34"



Recycle bin cabinet



POWER TOOLS

AIR TOOLS

TOOL STORAGE

HAND TOOLS

WORKSHOP EQUIPMENT

SPECIALIST VEHICLE TOOLS

MST340001

Wall cabinet with 1 shelf

Lock + key



Depth	500 mm
Weight	42 kg

861 mm

953 mm

MST341031

Wall cabinet with 3 drawers and one shelf

Lock + key



Depth	500 mm
Drawers	3
Drawer capacity	40 kg
Foam capacity	7 x 4
Weight	48.3 kg

861 mm

953 mm

MST340021

Wall cabinet with 2 drawers



Depth	500 mm
Drawers	2
Drawer capacity	70 kg
Foam capacity	2 x 4
Weight	51 kg

861 mm

953 mm

MST340051

Wall cabinet with 5 drawers



Depth	500 mm
Drawers	5
Drawer capacity	40 kg
Foam capacity	5 x 4
Weight	63 kg

861 mm

953 mm

MST340091

Wall cabinet with 9 drawers



Depth	500 mm
Drawers	9
Drawer capacity	40 kg
Foam capacity	9 x 4
Weight	63 kg

861 mm

953 mm



CREATE YOUR OWN WORKSPACE!
WWW.BOXO.TOOLS

MST341021

Multi function cabinet



Depth	500 mm
Drawers	2
Drawer capacity	40 kg
Weight	44.3 kg

MST340011

Recycle bin cabinet



Depth	500 mm
Weight	42.5 kg

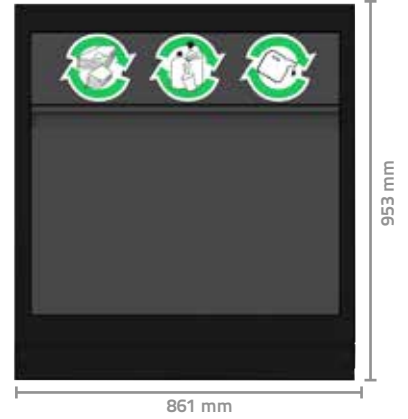

MST340071

Wall cabinet with 7 drawers



Depth	500 mm
Drawers	7
Drawer capacity	40 kg
Foam capacity	7 x 4
Weight	68 kg

MST340081

Wall cabinet with 8 drawers

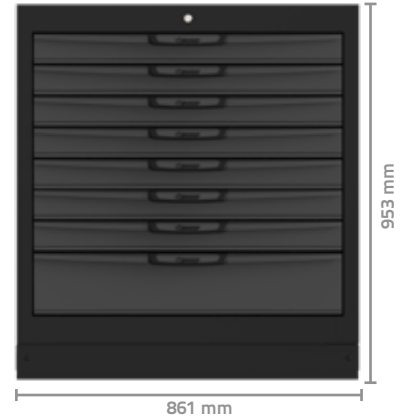

Depth	500 mm
Drawers	8
Drawer capacity	40 kg
Foam capacity	8 x 4
Weight	63 kg

MST260072

7 Drawer trolley for OSM (4 swivel casters)



Depth	459 mm
Drawers	7
Drawer capacity	40 kg
Foam capacity	7 x 3
Weight	56 kg

MST340072

7 Drawer trolley for OSM



Depth	459 mm
Drawers	7
Drawer capacity	40 kg
Foam capacity	7 x 4
Weight	71 kg

POWER TOOLS

AIR TOOLS

TOOL STORAGE

HAND TOOLS

WORKSHOP EQUIPMENT

SPECIALIST VEHICLE TOOLS

MST240001

Wallcabinet with 3 shelves

Lock + key



Depth	500 mm
Weight	64 kg

MST44001

Double wallcabinet with 3 shelves

Lock + key



Depth	500 mm
Weight	112 kg

MST3400AGW

Oil/ Air/ Electrical reel cabinet (without reels)

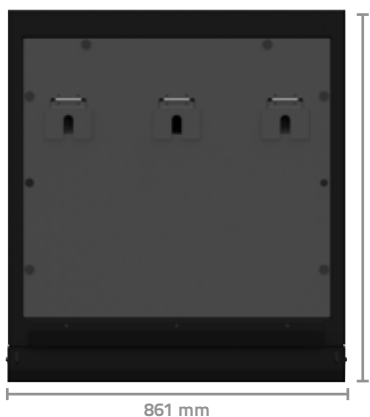

Depth	500 mm
Weight	53 kg

MST30001A

Corner cabinet with one shelf

Lock + key

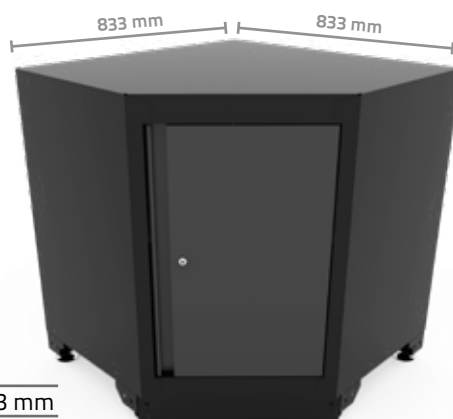

Depth	883 mm
Weight	56 kg

MST9012-1

Air-electrical-reel workbench foot without reels and worktop, with power socket and 2 USB connections

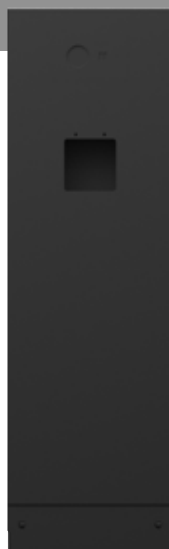

Beispiel

MSC340001

Cupboard

Lock + key

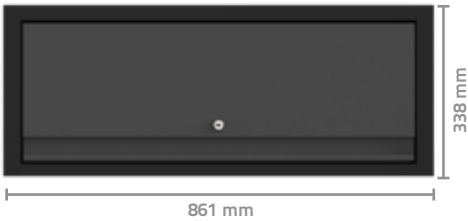

Depth	500 mm
Weight	13.3 kg

AB68001

Wall storage system with shutter

- Lock + key
- Inside depth 80 mm



Depth	140 mm
Weight	55 kg

MSN002-3

Backpanel
(single no holes)

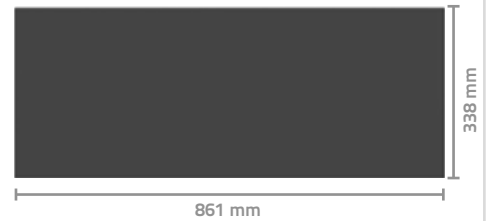

Depth	20 mm
Weight	3 kg

MSN002-1

Perforated panel
861x20x338mm (single)

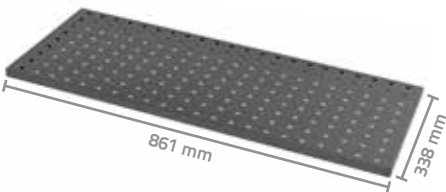

Depth	20 mm
Weight	6 kg

MSN002

Perforated panel
861x20x338 mm 2pc

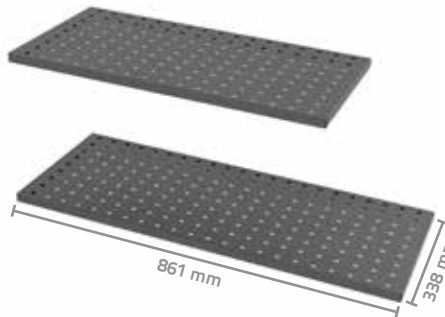

Depth	20 mm
Weight	12 kg

MST3400S11 + MSN002S

Backpanel stainless steel
861x20x338mm (for sink)



Depth	20 mm
Weight	4 kg

MSN002P+004

Perforated panel
with Powerframe



Powerframe for OSM 2x 230V - 2x USB



Depth	20 mm
Weight	3.5 kg

MSN002-4-1

Backpanel 10 cm high
861x20x140mm (stopper)

Depth	20 mm
-------	-------

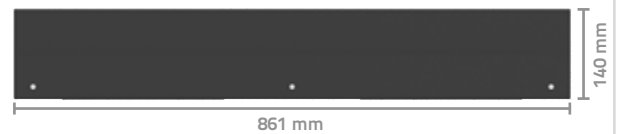

MSN002-4-2

Backpanel 10 cm high
1725x20x140mm (Stopper)

Depth	20 mm
-------	-------



POWER TOOLS

AIR TOOLS

TOOL STORAGE

HAND TOOLS

WORKSHOP EQUIPMENT

SPECIALIST VEHICLE TOOLS

MSN007-2

Shelf for OSM



▪ 20 kg



MSN008-2

Universal box rack



MSN011-2

Lamp holder for OSM version 2

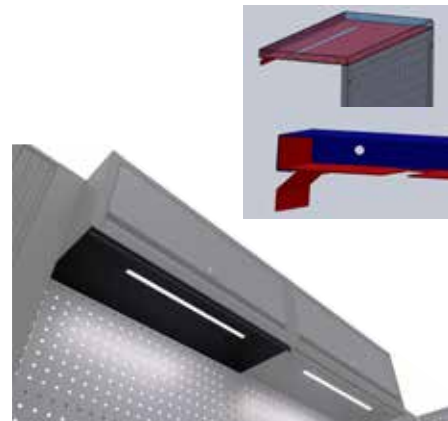

MSN003-M

Bracket middle 146x30x1980 mm

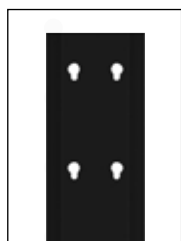
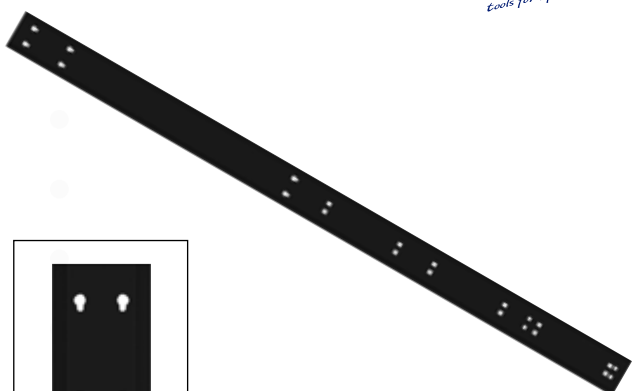

MSN003-RL

Bracket left/right 90x30x1980 mm

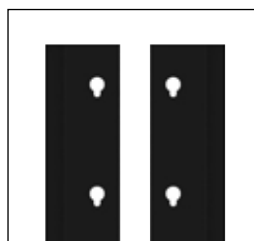
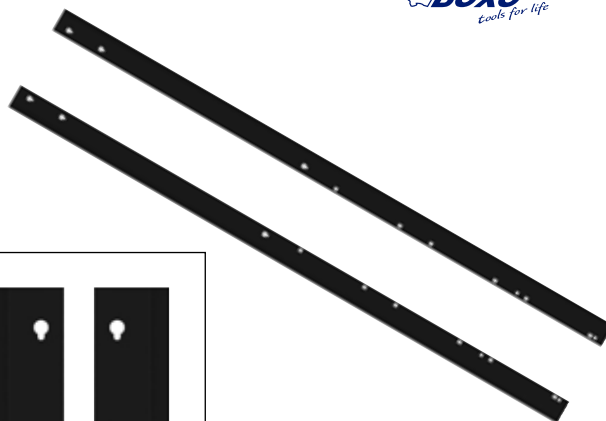

MSN003S-M

Bracket middle short 146x30x1287 mm

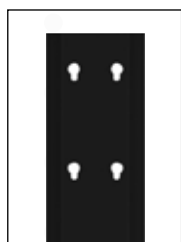
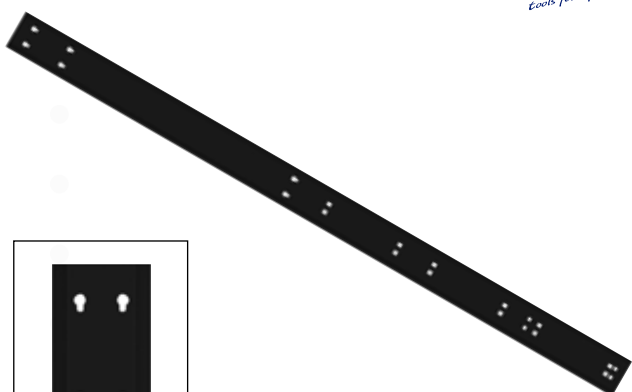

MSN003S-RL

Bracket short left/right 90x30x1287 mm

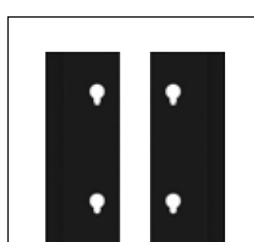
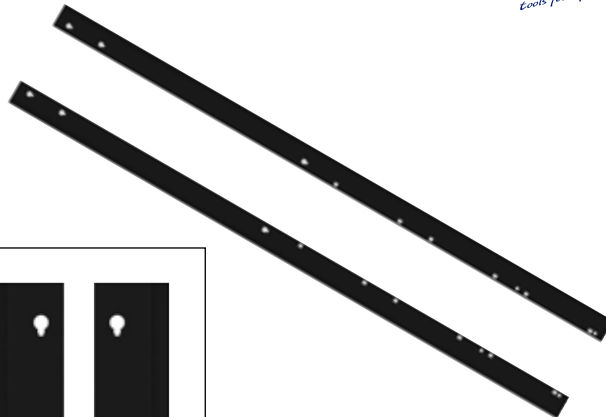

MSF005-SERIE

Multiplex work top



	Size (LxWxH) (mm)
MSF005-03	1722x500x40
MSF005-11	2588x500x40
MSF005-14A	2588x700x40
MSF005-15A	1725x700x40

MSN005-SERIE

Wooden work top



	Size (LxWxH) (mm)
MSN005-03C	1725x500x40
MSN005-11C	2588x500x40
MSN005-14A	2588x700x40
MSN005-15A	1725x700x40
P-MST-08WA	883x883x40

MSS005-SERIE

Stainless steel work top



	Size (LxWxH) (mm)
MSS005-03A	1725x500x40
MSS005-11A	2588x500x40
MSS005-14A	2588x700x40
MSS005-15A	1725x700x40
P-MST-08A	883x883x40

POWER TOOLS

AIR TOOLS

TOOL STORAGE

HAND TOOLS

WORKSHOP EQUIPMENT

SPECIALIST VEHICLE TOOLS

P-MST-01

Side panel low wall cabinet 472 mm



P-MST-02

Side panel high wall cabinet 500 mm



P-MST-06

Back panel for roller cabinet MST340072



P-MST-03

Shelf for MST240001 2pc



P-MST-04

Shelf for cabinet MST340001



P-MST-05

Shelves for corner cabinet MST30001A



P-MST-07

Shelves for double door cabinet MST44001



P-MST-09

Connect panel 2pc/set (70cm)



P-MST-09A

Connect panel for corner cabinet 700 mm



<p>P-MST-06-01</p>	<p>P-OSM-24H</p>	<p>P-OSM-44H</p>
<p>Connection sheet for back panel (4) (when not using brackets)</p>  	<p>Hanger tube for MST240001</p>  	<p>Hanger tube for MST44001</p>  
<p>P-OSM-BB-24</p>	<p>P-OSM-BB-34</p>	<p>P-OSM-BB-44</p>
<p>Front baseboard for 24" high cabinet</p>  	<p>Front baseboard for 34" OSM cabinet</p>  	<p>Front baseboard for 44" high cabinet</p>  
<p>P-OSM-SBL</p>	<p>13-16G</p>	<p>P-OSM-AGW</p>
<p>L support bracket for worktop</p>  	<p>Ball bearing slider for AT(B) trolleys 2pc</p>  	<p>Plinth cover for MST3400AGW (drain)</p>  

POWER TOOLS
 AIR TOOLS
 TOOL STORAGE
 HAND TOOLS
 WORKSHOP EQUIPMENT
 SPECIALIST VEHICLE TOOLS

P-OSM-SBF

Support bracket adjustable feet for worktop



Without a side cabinet on it's side



P-OSM-SBF-02

Side panel for P-OSM-SBF



P-OSM-SBF-03

L-bracket for P-OSM-SBF-03

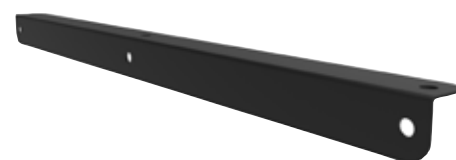

P-OSM-SBF-04

L-bracket for stand



P-KEYLOCK-C-N1

Key & lock for OSM trolley cabinet No. 1



Key & lock for OSM drawer cabinet MST340071



P-KEYLOCK-D-N1

Key and lock for OSM topchest/closet No. 1



Key and lock for OSM topchest & closet



Z007-KEY

Single key without profile 2pc



<p>MAA008</p> <p>Paper holder</p> <p>For tool trolleys and OSM</p> 	<p>MAA021</p> <p>Document holder for ATB-serie and OSM</p> 	<p>MAA003</p> <p>Can holder</p> <p>For tool trolleys and OSM</p> 
<p>MAA011A</p> <p>Holder for impact wrenches</p> <p>For tool trolleys and OSM</p> 	<p>P-TSH-20</p> <p>Single pen tool hanger 50 mm</p> 	<p>P-TDH-20</p> <p>Double pen tool hanger 50 mm</p> 
<p>MAA034</p> <p>Impact socket holder</p> <p>For tool trolleys and OSM</p> 	<p>P-TSH-40</p> <p>Single pen tool hanger 95 mm</p> 	<p>P-TDH-40</p> <p>Double pen tool hanger 95 mm</p> 

POWER TOOLS
 AIR TOOLS
 TOOL STORAGE
 HAND TOOLS
 WORKSHOP EQUIPMENT
 SPECIALIST VEHICLE TOOLS

DD009-01

Fix panel front and back 566x62 mm, 2pc



- Applicable for 26" cabinet drawer
- Package: 2pc/set
 - In PE Bag

Size (LxH) (mm) 566x62



1

DD009-01C

Fix panel front and back 750x62 mm, 2pc



- Applicable for 34" cabinet
- Package: 2pc/set
 - In PE Bag

Size (LxH) (mm) 750x62



2

DD009-10

Partition- straight -metal 395x49 mm, 2pc



- To combine with deviders
- Package: 2pc/set
 - In PE Bag

Size (LxH) (mm) 395x49



3

DD009A-14

Drawer divider-aluminum 127x50 mm, 5pc



- Package: 5pc/set
- In PE Bag

Size (LxH) (mm) 127x50

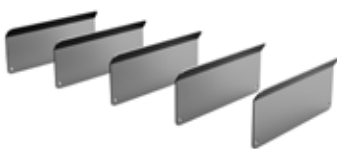

4

DD009A-15

Drawer divider-aluminum 260x50 mm, 1pc



- Package: 1pc
- In PE Bag

Size (LxH) (mm) 260x50

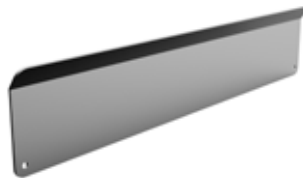

5

DD009A-16

Partition - straight - aluminum 395x50 mm, 5pc



- Package: 5pc/set
- In PE Bag

Size (LxH) (mm) 395x50

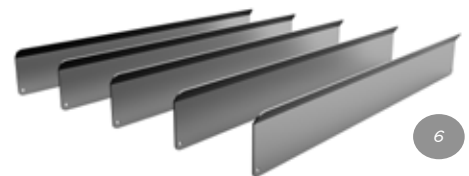

6

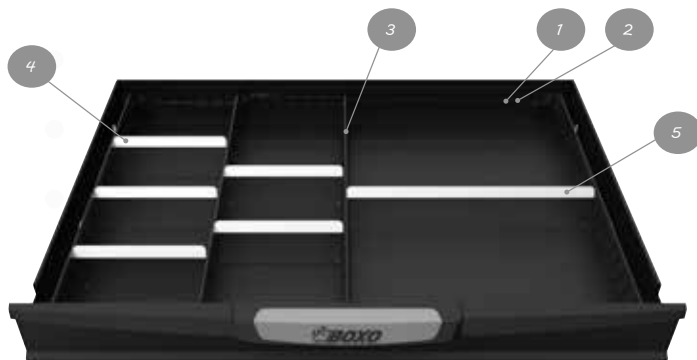

BXP000-1 3/3 **BXP000-2** 3/3 **BXP000-3** 3/3

Empty tray with 4 compartments



Empty tray with 3 compartments



Empty tray with 10 compartments



Size (LxH) (mm) 568x395

Size (LxH) (mm) 568x395

Size (LxH) (mm) 568x395



BX000-1 1/3 **BX000-3** 1/3

Empty foam tray with 1 box



Empty foam tray with 3 boxes



Size (LxH) (mm) 398x189

Size (LxH) (mm) 398x189

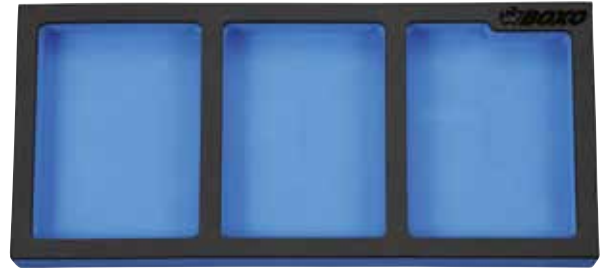

BXP-000-6/7/8/9 1/3

Size (LxH) (mm) 398x189

Empty tray with 2 compartments



Empty tray with 4 compartments



Empty tray with 8 compartments



Empty tray with 12 compartments



POWER TOOLS

AIR TOOLS

TOOL STORAGE

HAND TOOLS

WORKSHOP EQUIPMENT

SPECIALIST VEHICLE TOOLS

MS104W



MS101



MS102



MS103W



POWER TOOLS

AIR TOOLS

MS105



TOOL STORAGE

HAND TOOLS

MS106

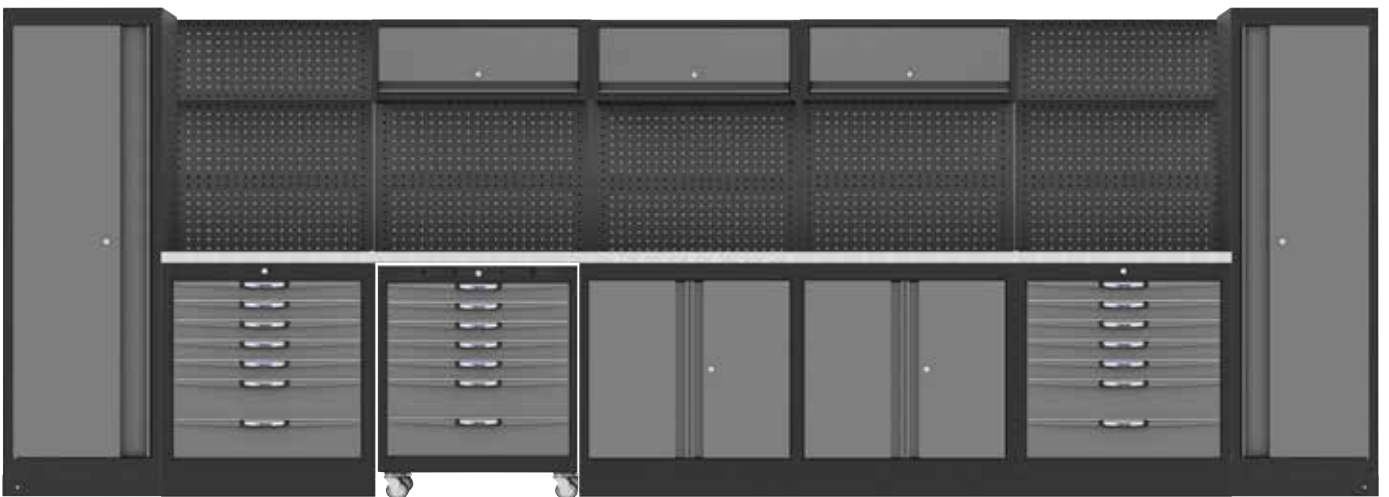

WORKSHOP EQUIPMENT

SPECIALIST VEHICLE TOOLS

MS107



MS108



MS109



MS110



MS111W



MS112W



POWER TOOLS

AIR TOOLS

TOOL STORAGE

HAND TOOLS

WORKSHOP EQUIPMENT

SPECIALIST VEHICLE TOOLS

MS113



MST110F



MST111



POWER TOOLS

MST112

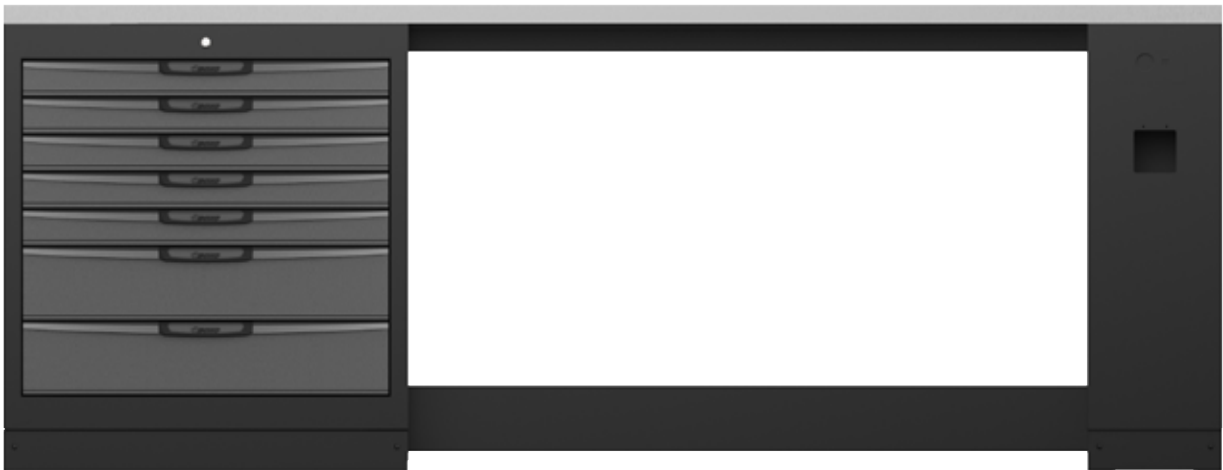

AIR TOOLS

TOOL STORAGE

MST113W



HAND TOOLS

WORKSHOP EQUIPMENT

SPECIALIST VEHICLE TOOLS

ECC20301BK

Filled carry box with 3 drawers 94pc



- Safety-insert-system: all tools are securely embedded, missing tools are noticed immediately
- Auto returning ball bearing slider for smooth opening and closing
- Complete with 94 piece assortment
- Lock & key
- Two-component soft foam
- Weight: 20 kg

Contents:

- Socket set 1/4" - 1/2" 68pc
- Combination wrench set 12pc
- Screwdriver set 9pc
- Combination set 5pc

Depth (mm)	459
Height (mm)	681
Width (mm)	860



Socket set 1/4" - 1/2" 68pc



Screwdriver set 9pc



Combination wrench set 12pc



Combination set 5pc



AC20301

Empty carrybox



BXH20-F056

Tool set in nylon bag 56pc



- Locking pliers 250 mm
- Combination pliers 175 mm
- 9x Allen key set
- 9x Combination wrench set 8, 10, 11, 12, 13, 14, 15, 17, 19 mm
- 3x Screwdriver PH0x75 mm, PH1x75 mm, PH2x100 mm
- 3x Screwdriver slotted 3x75, 4x100, 6x100 mm
- Waterpump pliers 250 mm
- Hammer 500 g
- Universal scissor
- 5x Chisel & punch set
- Utility knife
- Diagonal cutter 150 mm
- Combination hammer
- Hack saw 150 mm
- Measuring tape 5 m
- 1/4" Socket set 17pc



TB003

Nylon bag (empty)



Specification nylon bag TB0003:

- Universal heavy duty design
- Water tight tool compartments
- Stainless steel handle with rubber grip
- Shoulder straps
- Dimensions: 420x250x300 mm

Depth (mm)	300
Height (mm)	250
Width (mm)	420



POWER TOOLS

AIR TOOLS

TOOL STORAGE

HAND TOOLS

WORKSHOP EQUIPMENT

SPECIALIST VEHICLE TOOLS

BXE179

3/3 3/3 1/4" 1/2"



1/4" & 1/2" 178pc Toolset

- 1/4" Socket Bit H3, H4, H5, H6
- 1/4" Socket Bit PH0, PH1, PH2, PH3
- 1/4" Socket Bit PZ1, PZ2, PZ3
- 1/4" Socket Bit SL4 ~ SL6.5
- 1/4" Socket Bit T8, T10, T15, T20, T25, T27, T30, T40, T45, T55, T60
- 1/4" Socket 4, 4.5, 5, 5.5, 6, 7, 8, 9, 10, 11, 12, 13, 14 mm
- 1/4" Deep socket 4, 5, 6, 7, 8, 9, 10 mm
- 1/4" TX-E Socket E4, E5, E6, E7, E8
- 50x 1/4" bits
- 1/2" TX socket 10, 11, 12, 13, 14, 15, 17, 19, 21, 22, 24, 27, 30, 32 mm
- 1/2" Deep socket 16, 17, 18, 19, 22 mm
- 1/2" TX-E Socket E20, E22, E24
- Slotted Screwdriver 6x38 mm, 4x100 mm, 6x100 mm, 8x150 mm
- Phillips Screwdriver PH2x38 mm, PH1x100 mm, PH2x100 mm, PH3x150 mm
- Combination wrench 8, 9, 10, 11, 12, 13, 14, 15, 16, 17, 18, 19 mm
- Hex Key Wrench Set 9pc
- Diagonal Pliers 160 mm
- Long Nose Pliers 210 mm
- Combination Pliers 180 mm
- Water Pump Pliers 260 mm
- Engineers Hammer 300 g
- Measuring tape 5 m
- Punch and chisel set in plastic holder 5pc

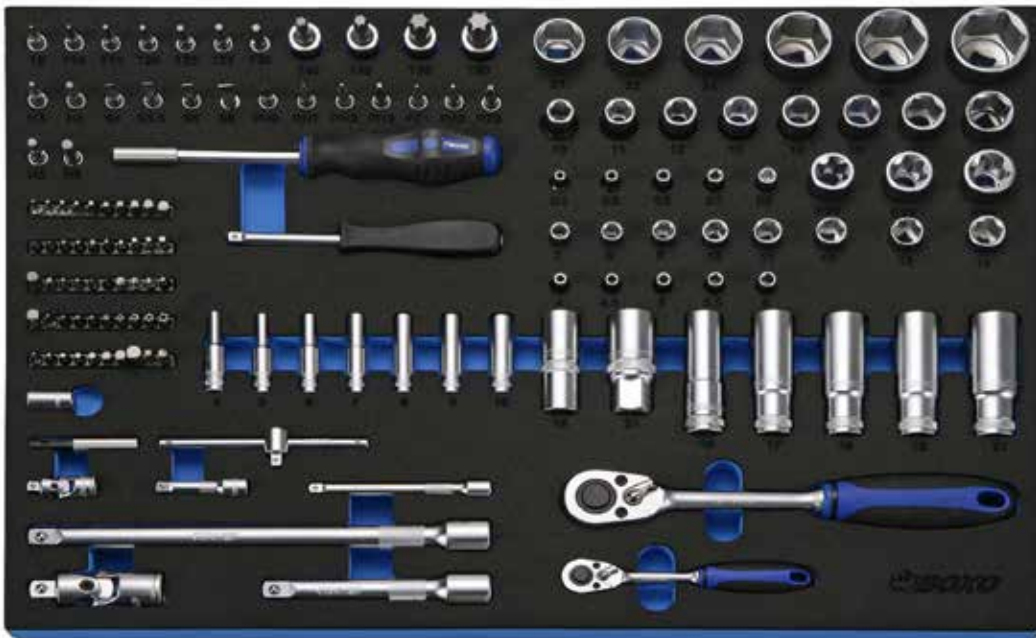

BXE013

3/3 3/3 3/3 3/3 3/3 1/4" 3/8" 1/2"



1/4", 3/8" & 1/2" 330pc Toolset

- 1/4" Sockets (6Pt) 4, 4.5, 5, 5.5, 6, 7, 8, 9, 10, 11, 12, 13, 14 mm
- 1/4" Deep sockets (6Pt) 4, 4.5, 5, 5.5, 6, 7, 8, 9, 10, 11, 12, 13, 14 mm
- 1/4" TX-E Socket E4, E5, E6, E7, E8
- 1/4" Hex socket bit H3, H4, H5, H6, H7, H8, T8, T10, T15, T20, T25, SL4, SL5.5, SL6, SL8, PH0, PH1, PH2, PH3
- 1/4" 72 Teeth ratchet
- 1/4" Extension bars 50, 100, 150 mm
- 1/4" Universal Joint
- 1/4" Adapter 1/4" F x 3/8" M
- 1/4" Spinner handle
- 1/4" Sliding T-handle 115 mm
- 1/4" Bit holder screwdriver 100 mm
- 50 pcs 1/4" Bit set
- 3/8" Sockets (6Pt) 6, 7, 8, 9, 10, 11, 12, 13, 14, 15, 16, 17, 18, 19, 20, 21, 22, 24 mm
- 3/8" Deep sockets (6Pt) 6, 7, 8, 9, 10, 11, 12, 13, 14, 15, 16, 17, 18, 19, 20, 21, 22, 24 mm
- 3/8" TX-E Sockets E10, E11, E12, E14
- 3/8" 72 Teeth ratchet
- 3/8" Extension bars 75, 150, 250 mm
- 3/8" Universal Joint
- 3/8" Adapter 3/8" F x 1/2" M
- 3/8" Spark plug sockets 16, 21 mm
- 3/8" TX socket bits T15, T20, T25, T27, T30, T40, T45
- 3/8" Hex socket bits H4, H5, H6, H7, H8, H10
- 1/2" Sockets (6Pt) 8, 9, 10, 11, 12, 13, 14, 15, 16, 17, 18, 19, 20, 21, 22, 23, 24, 26, 27, 30, 32 mm
- 1/2" Deep sockets (6Pt) 10, 11, 12, 13, 14, 15, 16, 17, 18, 19, 21, 22, 24, 27, 30, 32 mm
- 1/2" TX-E Sockets E10, E12, E14, E16, E18, E20, E22, E24
- 1/2" 72 Teeth ratchet
- 1/2" Universal Joint
- 1/2" Extension bars 125, 250 mm
- 1/2" Adapter 1/2" F x 3/8" M
- 1/2" Spark plug sockets 16, 21 mm
- 1/2" Bitsockets (55 mm)
 - H5, H6, H7, H8, H10, H12, H14,
 - T20, T25, T27, T30, T40, T45, T50, T55, T60, T70,
 - TP30, TP40, TP45, TP50, TP55, TP60,
 - M8, M10, M12
- 1/2" XL Bitsockets (100 mm)
 - H5, H6, H7, H8, H10, H12, H14,
 - M14, M16, M18
- Gasket scraper
- Utility knife w/ 6pcs spare blade
- Measuring tape 5 m
- Cape chisel 5x130 mm
- Cold chisels 12x150, 18x180, 22x200 mm
- Pin punches 2x115, 3x125, 4x150, 5x165, 6x180, 8x180 mm
- Taper punch 3x120 mm
- Center punch 4x120 mm
- Scissor
- Engineer Hammer 500g
- Soft PU hammer 35 mm
- Auto center punch
- 1/4" Flexible bit screwdriver 500 mm
- Curve jaw locking plier 250 mm
- Adjustable wrench 250 mm
- Waterpump plierps 250 mm
- Heavy duty diagonal cutter 175 mm
- Long nose plier 200 mm
- Combination plier 175 mm
- Bent long nose plier 200 mm
- 4pcs Circlip pliers 175 mm



POWER TOOLS

AIR TOOLS

TOOL STORAGE

HAND TOOLS

WORKSHOP EQUIPMENT

SPECIALIST VEHICLE TOOLS

BASIC-SET

1/4" 1/2"

Basic set 148pc



- BX037 1/4" socket set 72pc
- BX038 1/2" socket set 24pc
- BX006 Combination wrench set 16pc
- BX004A Screwdriver set 8pc
- BX005TA TX Screwdriver set 7pc
- BX009 Plier set 4pc
- BX047 File, hammer and measuring set 17pc



STARTER-SET

1/4" 1/2"

Tool set 240pc



- BX037 72x 1/4" Metric socket set
- BX038 24x 1/2" Metric socket set
- BX015A 64x 1/2" Metric socket and bits set
- BX006 16x Metric combination wrench set
- BX045 13x Reversible gear wrench and measuring tape measure set
- BX022A 15x Flex head gear wrench set
- BX004A 8x Screwdriver set
- BX005TA 7x TX screwdriver set
- BX012 10x Precision screwdriver & mini plier set
- BX009 4x Plier set
- BX028 3x 280 mm Long nose plier set
- BX025 4x Circlip plier set



PREMIUM-SET

1/4" 1/2"

Premium set 257pc



- BX037 72x 1/4" Metric socket set
- BX038 24x 1/2" Metric socket set
- BX015A 64x 1/2" Metric socket and bits set
- BX006 16x Metric combination wrench set
- BX045 13x Reversible gear wrench and measuring tape measure set
- BX022A 15x Flex head gear wrench set
- BX004A 8x Screwdriver set
- BX005TA 7x TX screwdriver set
- BX012 10x Precision screwdriver & mini plier set
- BX009 4x Plier set
- BX028 3x 280 mm Long nose plier set
- BX025 4x Circlip plier set
- BX047 17x File, hammer and measuring set



POWER TOOLS

AIR TOOLS

TOOL STORAGE

HAND TOOLS

WORKSHOP EQUIPMENT

SPECIALIST VEHICLE TOOLS

EXECUTIVE-SET

1/4" 1/2"



Tool set 291pc

BX037

BX038

BX015A



- BX037 1/4" Metric socket set 72pc
- BX038 1/2" Metric socket set 24pc
- BX015A 1/2" Metric socket and bits set 64pc

BX006

BX045

BX022A



- BX006 Metric combination wrench set 16pc
- BX045 Reversible gear wrench and measuring tape measure set 13pc
- BX022A Flex head gear wrench set 15pc

BX004A

BX005TA

BX012



- BX004A Screwdriver set 8pc
- BX005TA TX screwdriver set 7pc
- BX012 Precision screwdriver & mini plier set 10pc

BX009

BX028

BX025



- BX009 Plier set 4pc
- BX028 280 mm Long nose plier set 3pc
- BX025 Circlip plier set 4pc

BX047



- BX047 File, hammer and measuring set 17pc

BX073



- BX073 Air impact wrench, impact socket and torque wrench set 34pc



MAA013
 Back panel ATB-serie



 **BOXO**[®]
tools for life

- POWER TOOLS
- AIR TOOLS
- TOOL STORAGE**
- HAND TOOLS
- WORKSHOP EQUIPMENT
- SPECIALIST VEHICLE TOOLS

HAND TOOLS



POWERHAND®
POWER FOR PROFESSIONALS

Our Powerhand brand continues to feature across the hand tools range with products such as bit sets, adjustable pliers, spanners and pry bars and new torque wrenches.







Our professional range of BOXO hand tools has continued to grow, and is a comprehensive hand tool offering. New products to this edition include additional ratchet and socket sets, multifix sockets, and a full range of individuals enabling the user to buy the most popular sizes or replace lost items without needing to replace an entire set. Most products in this range feature a limited lifetime warranty.

METRINCH®
IF THIS CAN'T DO IT, NO TOOL CAN

Our patented Metrinch wall drive profile drives only on the flats and not the corners, with specific calculations to enable a single Metrinch tool to be used on both metric and inch (AF, BSW & BSF) series fasteners. The specialist nature of Metrinch sockets and spanners make them ideal for use on worn and damaged bolts or even those completely rounded by abrasion.

SYMBOL GUIDE

 1/4" drive	 1/2" drive	 Blow mould case	 Chrome molybdenum
 3/8" drive	 3/4" drive	 6-point	 TX male
	 1" drive	 Spline	 Male
		 Flank drive	 Female

SUB-SECTIONS

- 112 TOOL-SYSTEM-MODULES
- 122 SOCKET SETS
- 124 SOCKET AND COMBINATION SETS
- 128 SOCKET RAIL SETS
- 132 RAILS
- 134 1/4" SOCKETS
- 137 3/8" SOCKETS
- 140 3/8" AND 1/2" SOCKETS
- 142 1/2" SOCKETS
- 146 3/4" SOCKETS
- 147 ACCESSORIES
- 150 RATCHETS
- 152 TORQUE WRENCHES
- 153 WRENCHES
- 168 SCREWDRIVERS
- 172 HEX AND TX-KEYS
- 174 BIT SETS
- 175 PLIERS
- 181 HAMMERS
- 182 PLIERS
- 184 PUNCHES AND CHISELS
- 185 PRYBARS AND PICK TOOLS
- 186 PICK AND CUTTING TOOLS
- 188 CUTTING TOOLS
- 189 MEASURING TOOLS
- 191 VDE TOOLS
- 197 CAULKING GUNS

BX037

1/3 1/4"

1/4" Socket set 72pc



- 1/4" Sockets (6Pt) 4, 4.5, 5, 5.5, 6, 7, 8, 9, 10, 11, 12, 13, 14 mm
- 1/4" Deep sockets (6Pt) 4, 4.5, 5, 5.5, 6, 7, 8, 9, 10, 11, 12, 13, 14 mm
- 72 Teeth ratchet, spinner handle 150 mm, sliding T-handle
- Universal joint
- Extension bars 50, 100, 150 mm
- Hex key wrenches 1.5, 2, 2.5, 3, 4, 5, 6, 8, 10 mm
- 1/4" Socket bit (36 mm)

6pt Cr-V



BX002A

1/3 3/8"

3/8" Socket set 29pc



- 3/8" Socket (6Pt) 7, 8, 9, 10, 11, 12, 13, 14, 15, 16, 17, 18, 19, 20, 21, 22, 24 mm
- Spark plug socket 16, 21 mm
- 72 Teeth ratchet
- Universal joint
- Sliding T-handle
- Bit coupler, 3/8" F x 1/4" M adapter, 3/8" F x 1/2" M adapter
- Extension bar 75, 150, 250 mm
- Magnetic extension bar

6pt Cr-V



BX038

1/3 1/2"

1/2" Socket set 24pc



- 1/2" Socket (6Pt) 8, 9, 10, 11, 12, 13, 14, 15, 16, 17, 19, 21, 22, 23, 24, 27, 30, 32 mm
- 72 Teeth ratchet
- Universal joint
- Breaker bar 375 mm
- Extension bar 125, 250 mm
- Sliding T-handle 300 mm

6pt Cr-V



BX001S-2

1/3 1/4"

1/4" SAE socket set 65pc



- Sockets SAE (6Pt) 5/32", 3/16", 7/32", 1/4", 9/32", 5/16", 11/32", 3/8", 7/16", 15/32", 1/2", 9/16"
- Deep sockets SAE (6Pt) 5/32", 3/16", 7/32", 1/4", 9/32", 5/16", 11/32", 3/8", 7/16", 15/32", 1/2", 9/16"
- 72 Teeth ratchet
- Spinner handle 150 mm
- Sliding T-handle
- Universal joint
- Extension bars 50, 100, 150 mm
- Hex key wrenches
- 1/4" Socket bits (36 mm)

6pt Cr-V



BX002S-2

1/3 3/8"

3/8" SAE socket set 21pc



- 3/8" Spark plug sockets 16, 21 mm
- 3/8" Sockets SAE (6Pt) 1/4", 5/16", 3/8", 7/16", 15/32", 1/2", 9/16", 5/8", 11/16", 3/4", 13/16", 7/8", 15/16"
- 72 Teeth ratchet
- Universal joint
- Sliding T-handle 165 mm
- Extension bars 75, 150, 250 mm

6pt Cr-V



BX003S-2

1/3 1/2"

1/2" SAE socket set 21pc



- 1/2" Sockets SAE (6Pt) 5/16", 3/8", 7/16", 15/32", 1/2", 9/16", 5/8", 11/16", 3/4", 13/16", 7/8", 15/16", 1", 1 1/16", 1 3/16", 1 1/4"
- 72 Teeth ratchet
- Universal joint
- Sliding T-handle
- Extension bars 125, 250 mm

12pt Cr-V



BX016

1/3 3/8"

3/8" Deep socket set 14pc



- Deep sockets (6Pt) 8, 9, 10, 11, 12, 13, 14, 15, 16, 17, 19, 21, 22, 24 mm

6pt Cr-V



BX017

1/3 1/2"

1/2" Deep socket set 14pc



- Deep sockets (6Pt) 10, 11, 12, 13, 14, 15, 17, 19, 21, 22, 24, 27, 30, 32 mm

6pt Cr-V

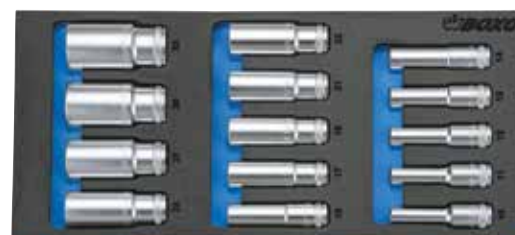

BX029

1/3 1/2"

1/2" Impact socket set 26pc

- Impact sockets (6Pt) 8, 9, 10, 11, 12, 13, 14, 15, 16, 17, 18, 19, 21, 22, 24 mm
- Deep impact sockets (6Pt) 17, 19, 21, 22, 24 mm
- Colour impact sockets with plastic sleeve (6Pt) 17, 19, 21 mm
- Impact universal joint
- Impact extension bar 125 mm
- 3/4" F * 1/2" M Adapter

6pt Cr-Mo



BX015A

1/3 1/2"

1/2" Socket bit and bit set 64pc

- Hex socket bits 5x138, 6x100, 7x100, 8x100 mm
- TX socket bits T40x138, T45x100, T55x138, T70x100 mm
- XZN socket bits M6x100, M8x100, M10x100, M12x100 mm
- Magnetic bit holder
- Bit set 50pc

XZN Cr-V



BX039

1/3 1/2"

1/2" Socket bit & impact socket set 15pc

- Hex socket bits 5x138, 6x100, 7x100, 8x100 mm
- TX socket bits T40x138, T45x100, T55x138, T70x100 mm
- XZN socket bits M6x100, M8x100, M10x100, M12x100 mm
- Deep impact sockets (6Pt) 17, 19, 21 mm

XZN 6pt Cr-V Cr-Mo



BX032

1/3 1/2"

1/2" Impact TX-E socket- & Hex impact socket set 28pc

- TX impact sockets E10, E11, E12, E14, E16, E18, E20, E22, E24
- Hex impact sockets H4, H5, H6, H8, H10, H12, H14, H17, H19
- TX impact sockets T20, T25, T27, T30, T40, T45, T50, T55, T60, T70

6pt XZN Cr-V Cr-Mo



BX091

1/3 1/4"

1/4", 3/8" & 1/2" Adapter, extension & universal joint set 16pc

- Adapters 3/8"x1/4", 1/4"x3/8", 3/8"x1/2", 1/2"x3/8"
- 1/4" Extension bars 50, 100, 150 mm
- 3/8" Extension bars 75, 150, 250 mm
- 1/2" Extension bars 75, 150, 250 mm
- Universal joints 1/4", 3/8", 1/2"

XZN Cr-V



BX092

1/3 1/4"

1/4", 3/8" & 1/2" Adapter, extension & universal joint set ball joint 16pc

- Adapters 3/8"-1/4", 1/4"-3/8", 3/8"-1/2", 1/2"-3/8"
- 1/4" Wobble extension bars 50, 100, 150 mm
- 3/8" Wobble extension bars 75, 150, 250 mm
- 1/2" Wobble extension bars 75, 150, 250 mm
- Universal joints 1/4", 3/8", 1/2"

XZN Cr-V



BX093

1/3 1/4" 3/8" 1/2"

1/4", 3/8" & 1/2" Adapter, extension & universal joint set magnetic 16pc

- Adapters 3/8"-1/4", 1/4"-3/8", 3/8"-1/2", 1/2"-3/8"
- 1/4" Magnetic extension bars 50, 100, 150 mm
- 3/8" Magnetic extension bars 75, 150, 250 mm
- 1/2" Magnetic extension bars 75, 150, 250 mm
- Universal joints 1/4", 3/8", 1/2"



Cr-V

BXS004

1/4" 3/8" 1/2"

1/4", 3/8", 1/2" & 3/4" Adapter set 6pc

- Adapter: 3/8" - 1/4" 1/4" - 3/8" 3/8" - 1/2" 1/2" - 3/8" 1/2" - 3/4" 3/4" - 1/2"



Cr-V

BXS005

1/4" 3/8" 1/2"

1/4", 3/8" & 1/2" universal joint set 3pc



Cr-V

B-SHR3

1/3 1/4" 3/8" 1/2"

3Pc swivel head ratchet set in foam



- 1/4" Swivel head ratchet
- 3/8" Swivel head ratchet
- 1/2" Swivel head ratchet

Cr-V



B-SLR3

1/3 1/4" 3/8" 1/2"

3Pc slimline ratchet set in foam



- 1/4" Slimline ratchet
- 3/8" Slimline ratchet
- 1/2" Slimline ratchet

Cr-V

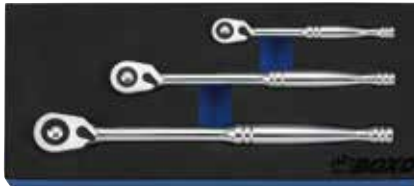

B-PHR3

1/3 1/4" 3/8" 1/2"

3Pc pear-head ratchet set in foam



- 1/4" Pear-head ratchet
- 3/8" Pear-head ratchet
- 1/2" Pear-head ratchet

Cr-V



BX128

1/2" Air impact socket set 26pc



1/3 1/2"

BX212

1/2" Socket set 12Pt 24pc



Cr-Mo

12pt Cr-V

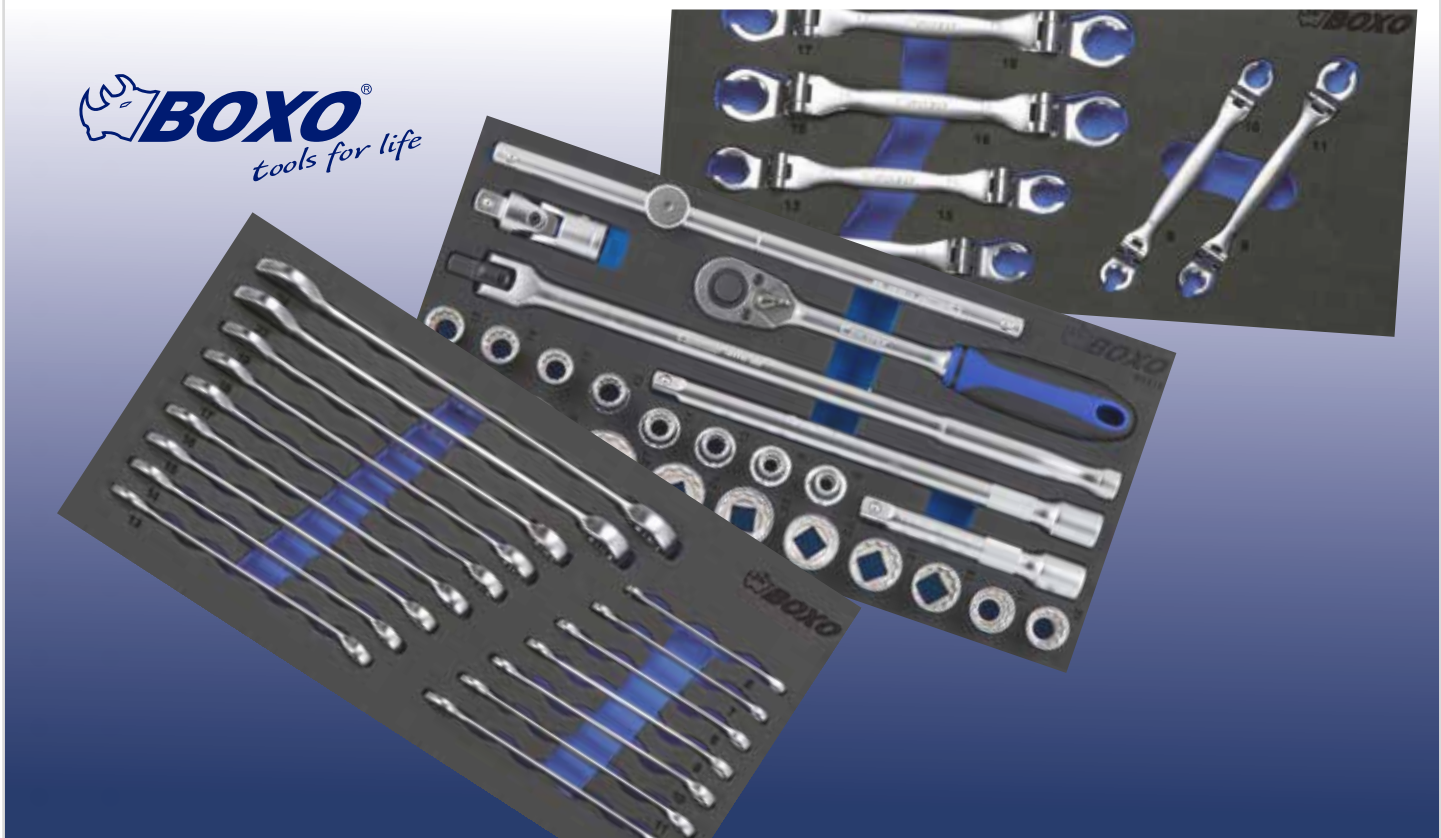

VVE051

1/2" XZN socket bit set 26pc

- M5-M16-55 mm
- M5-M14-100 mm
- M5-M14-140 mm
- M8-M14-200 mm



1/2 1/2"

POWER TOOLS

AIR TOOLS

VVE052

1/2" Hex bit socket set 30pc

- H5-H19-55 mm
- H5-H13-100 mm
- H5-H14-140 mm
- H5-H12-200 mm



1/2 1/2"

TOOL STORAGE

HAND TOOLS

VVE053

1/2" TX bit socket set 32pc

- TX20-TX70-55 mm
- TX20-TX70-100 mm
- TX40-TX70-140 mm
- TX40-TX70-200 mm



1/2 1/2"

WORKSHOP EQUIPMENT

SPECIALIST VEHICLE TOOLS

BX033

1/3 1/2" 1/4"

1/2" & 1/4" TX-socket set & TX-ring ratchet set 39pc



- 1/4" TX-E sockets E4, E5, E6, E7, E8 & E10
- 1/2" TX-E sockets E11, E12, E14, E16, E18, E20, E22, E24
- TX sockets T10, T15, T20, T25, T27, T30, T40, T45, T50, T55, T60, T70
- TX-E wrenches E6xE8, E10xE12, E14xE18, E20xE24
- Long TX key wrenches T10, T15, T20, T25, T27, T30, T40, T45, T50



BX051

1/3 1/2" 1/4"

1/2" & 1/4" TX-E socket set & TX-double ring wrench set 23pc



- 1/4" TX-E sockets E4, E5, E6, E7
- 1/2" TX-E sockets E10, E12, E14, E16, E18, E20
- TX-E wrenches E6xE8, E10xE12, E14xE18, E20xE24
- TX key wrench set (short type) T10, T15, T20, T25, T27, T30, T40, T45, T50



BX019

1/3

Double flex-socket wrench set 7pc



- 6x7, 8x9, 10x11, 12x13, 14x15, 16x17, 18x19 mm



BX041

1/3

Double open end wrench & pin punch set 15pc



- Double open end wrenches 6x7, 8x9, 10x11, 12x13, 14x15, 16x17, 18x19, 21x23, 22x24 mm
- Pin punch 2x115, 3x125, 4x150, 5x165, 6x180, 8x180 mm

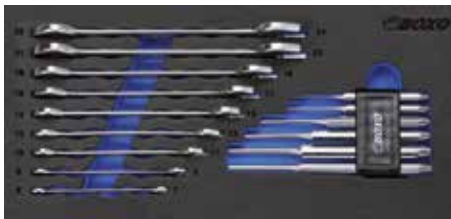

BX006

1/3

Combination wrench set 16pc



- Combination wrenches 6, 7, 8, 9, 10, 11, 12, 13, 14, 15, 16, 17, 18, 19, 22, 24 mm

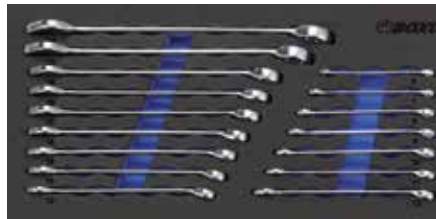

BX042

1/3

Offset 75° double ring wrench & Hex-key set 17pc



- 75° offset double ring wrenches 6x7, 8x9, 10x11, 12x13, 14x15, 16x17, 18x19, 20x22 mm
- HEX key set 1.5, 2, 2.5, 3, 4, 5, 6, 8, 10 mm



BX067A

1/3

Double open end wrench set 3pc



- Double open end wrenches 24x27, 30x32, 36x41 mm



BX057

1/3

Combination wrench set 4pc



- Combination wrenches 27, 29, 30, 32 mm



BX058

1/3

75° Offset double ring wrench set 4pc



- Offset double ring wrenches 21x23, 24x26, 25x28, 30x32 mm

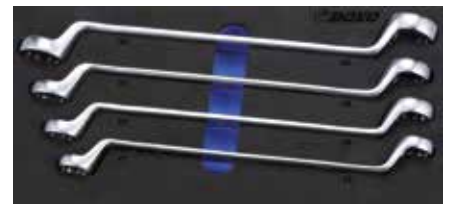

BX024

1/3

Ratcheting wrench set 12pc



- Ratcheting wrenches 8, 9, 10, 11, 12, 13, 14, 15, 16, 17, 18, 19 mm

12pt Cr-V



BX045

1/3

Reversible gear wrench set and measuring tape 13pc



- Ratcheting Wrenches 8, 9, 10, 11, 12, 13, 14, 15, 16, 17, 18, 19 mm
- Measuring tape (5 m)

12pt Cr-V



BX022A

1/3

Flex-head ratcheting wrench set 15pc



- Flex-head ratcheting wrenches 8, 9, 10, 11, 12, 13, 14, 15, 16, 17, 18, 19 mm
- 1/4" x Adapter 10 mm
- 3/8" x Adapter 13 mm
- 1/2" x Adapter 19 mm

12pt Cr-V



BX074

1/3

Flare nut wrench set 6pc



- Flare Nut Wrenches 8x9, 10x11, 12x13, 14x15, 16x18, 17x19 mm

12pt 6pt Cr-V



BX076

1/3

Double flex-head flare nut wrench set 6pc



- 8x10, 9x11, 12x14, 13x15, 16x18, 17x19 mm

12pt 6pt Cr-V



BX077

1/3

Half-moon ring wrench & hex key set 13pc



- Half-moon Ring Wrench 8x10, 12x14, 13x15, 17x19 mm
- Hex key wrench (Long type) 1.5, 2, 2.5, 3, 4, 5, 6, 8, 10 mm

12pt Cr-V



BX007S-2

1/3

SAE Double open end wrench set 6pc



- 1/4"x5/16", 3/8"x7/16", 1/2"x9/16", 5/8"x11/16", 11/16"x3/4", 13/16"x7/8"

Cr-V



BX006S-2

1/3

SAE Combination wrench set 13pc



- 1/4", 5/16", 11/32", 3/8", 7/16", 1/2", 9/16", 5/8", 11/16", 3/4", 13/16", 7/8", 15/16"

12pt Cr-V



BX118S-2

1/3

SAE 45° Offset double ring wrench set 6pc



- 1/4"x5/16", 3/8"x7/16", 1/2"x9/16", 9/16"x5/8", 11/16"x3/4", 13/16"x7/8"

12pt Cr-V



POWER TOOLS







AIR TOOLS

TOOL STORAGE

HAND TOOLS

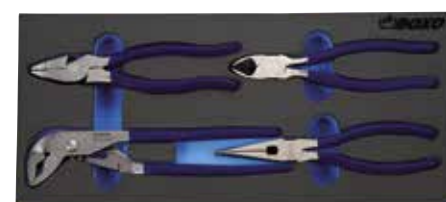
WORKSHOP EQUIPMENT

SPECIALIST VEHICLE TOOLS

<p>BX011 1/3</p> <p>Adjustable wrench set 3pc </p> <ul style="list-style-type: none"> Adjustable wrench 150 mm Adjustable wrench 200 mm Adjustable wrench 250 mm <p style="text-align: right;">Cr-V</p> 	<p>BX010 1/3</p> <p>Locking plier set 3pc </p> <ul style="list-style-type: none"> Long nose locking plier 160 mm Long nose locking plier 225 mm Curved jaw locking plier 250 mm 	<p>BX034 1/3</p> <p>Locking plier with multi angle flex screwdriver set 6pc </p> <ul style="list-style-type: none"> Locking plier 180 mm Locking plier 250 mm 
<p>BX026 1/3</p> <p>Plier set 5pc </p> <ul style="list-style-type: none"> W-type plier J-type plier LL-type plier J-type plier L-type plier 	<p>BX009 1/3</p> <p>Plier set 4pc </p> <ul style="list-style-type: none"> Diagonal cutting plier 160 mm Combination plier 180 mm Long nose plier 200 mm Water pump plier 250 mm 	<p>BX097 1/3</p> <p>Premium plier set 4pc </p> <ul style="list-style-type: none"> Diagonal cutter 175 mm Combination plier 185 mm Long nose plier 200 mm Waterpump plier 245 mm 
<p>BX025 1/3</p> <p>Circlip plier set 4pc </p> <ul style="list-style-type: none"> External circlip pliers 180 mm - straight nose External circlip pliers 180 mm - bent nose Internal circlip pliers 180 mm - straight nose Internal circlip pliers 180 mm - bent nose 	<p>BX098 1/3</p> <p>Premium plier set 150 mm 4pc </p> <ul style="list-style-type: none"> Diagonal cutter 150 mm Combination plier 150 mm Long nose plier 150 mm Bent long nose plier 150 mm 	<p>BX028 1/3</p> <p>280 mm Long nose plier set 3pc </p> <ul style="list-style-type: none"> Long nose plier 45° Long nose plier 90° Long nose plier 

BX013

1/3

Hammer & punch set 6pc



- Fitters hammer 500 g
- Plastic hammer
- Centre punch 4x185 mm
- Drift punches 4x150, 5x165, 6x180 mm



BX014

1/3

Punch & chisel set 17pc



- Pin punches 2x115, 3x125, 4x150, 5x165, 6x180, 8x180 mm
- Drift punches 3x120, 4x120, 5x120, 6x120 mm
- Chisels 10x140, 12x150, 16x180, 18x180, 22x200 mm
- Cape chisel 130 mm
- Automatic center punch

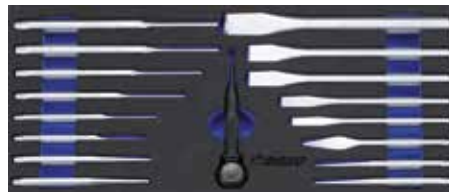

BX027

1/3

Steel file set 5pc



- Half-round file
- Flat file
- Triangle file
- Round file
- Square file



BX047

3/3

File, hammer, measuring, marking & cutting tool set 17pc



- Half-round file
- Flat file
- Triangle file
- Round file
- Square file
- Hammer 300 g
- Dead blow hammer 300 g
- Heavy duty utility knife
- Heavy duty hacksaw 300 mm
- Automatic center punch
- Stainless steel scriber
- SAE screw pitch gauges
- Metric screw pitch gauges
- Metric feeler gauge 20pc
- Vernier calliper 150 mm
- Circular protractor 200 mm
- Double ended scriber



BX000-1

1/3

Empty foam tray with 1 box



BX000-3

1/3

Empty foam tray with 3 boxes



BC001

Blow mould case for one foam inlay (empty)



POWER TOOLS

AIR TOOLS

TOOL STORAGE

HAND TOOLS

WORKSHOP EQUIPMENT

SPECIALIST VEHICLE TOOLS

BX004A

1/3

Screwdriver set - slotted and Philips 8pc



- Slotted screwdrivers 6x38, 3x75, 4x100, 6x100 mm
- Phillips screwdrivers PH0x75, PH1x100, PH2x38, PH2x100 mm

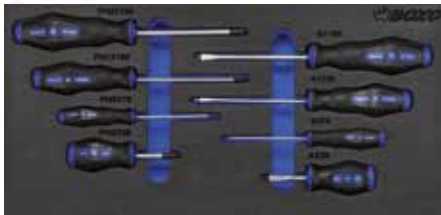

BX005A

1/3

Screwdriver set - slotted and Philips 7pc



- Slotted screwdrivers 6x38, 3x75, 4x100, 6x100 mm
- Phillips screwdrivers PH0x75, PH1x100, PH2x38, PH2x100 mm

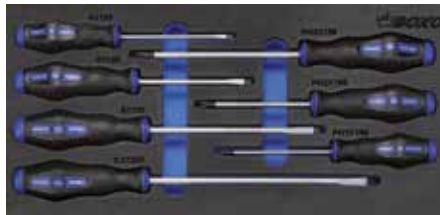

BX040

1/3

Screwdriver set 8pc



- Slotted screwdrivers 4x100, 6x38, 6x100, 8x150 mm
- Phillips screwdrivers PH1x100, PH2x38, PH2x100, PH3x150 mm

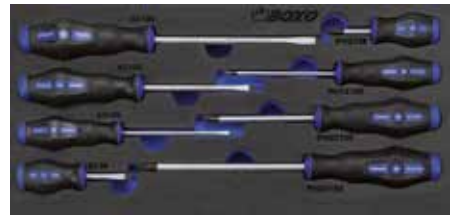
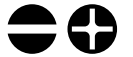

BX005

1/3

Go-through screwdriver set 7pc



- Slotted screwdrivers 5x100, 6x100, 8x100, 9.5x200 mm
- Phillips screwdrivers PH1x100, PH2x100, PH3x150 mm

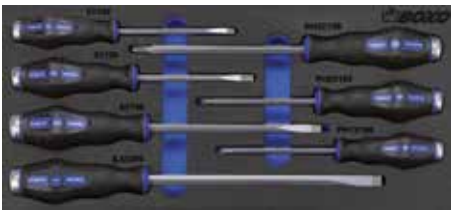

BX005TA

1/3

TX Screwdriver set 7pc



- TX screwdrivers T20x75, T25x100, T27x100, T30x100, T40x125, T45x150, T50x175 mm

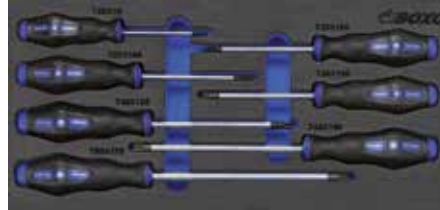

BX012

1/3

Precision screwdriver and mini plier set 10pc



- Precision screwdrivers PH 00X50, 0x50, 1x50 mm
- Slotted 1.5x50, 2x50 & 3x50 mm
- Mini pliers
- Combination plier 125 mm
- Diagonal cutting plier 115 mm
- Long nose plier 125 mm 45°
- Bent nose plier 125 mm

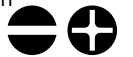

BX020

1/3

2 way T-Handle hex key set 8pc



- 2 way T-handle hex-key H2, H2.5, H3, H4, H5, H6, H8, H10

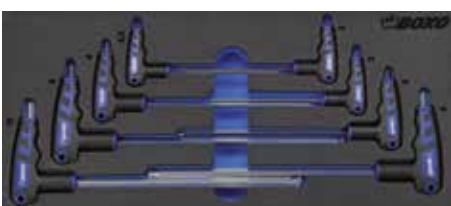

BX021

1/3

2 way T Handle TX-key set 9pc



- 2 way T-handle TX-key T10, T15, T20, T25, T27, T30, T40, T45, T50

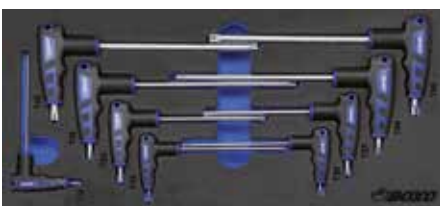

BX082

1/3

T-Handle socket set 9pc



- T-handle socket 6, 7, 8, 10, 11, 12, 13, 14, 17 mm



B-8015F

2/3

Screwdriver set in foam 15pc



- Slotted screwdrivers SL3x75, SL4x100, SL5.5x75, SL6x100, SL8x150, SL10x200
- Phillips screwdrivers PH0x75, PH1x75, PH2x100, PH2x150, PH3x150
- Pozi screwdrivers PZ0x75, PZ1x100, PZ2x100, PZ3x150
- Ergonomic comfort grips with non-slip
- Some drivers with a hex bolt and go-through

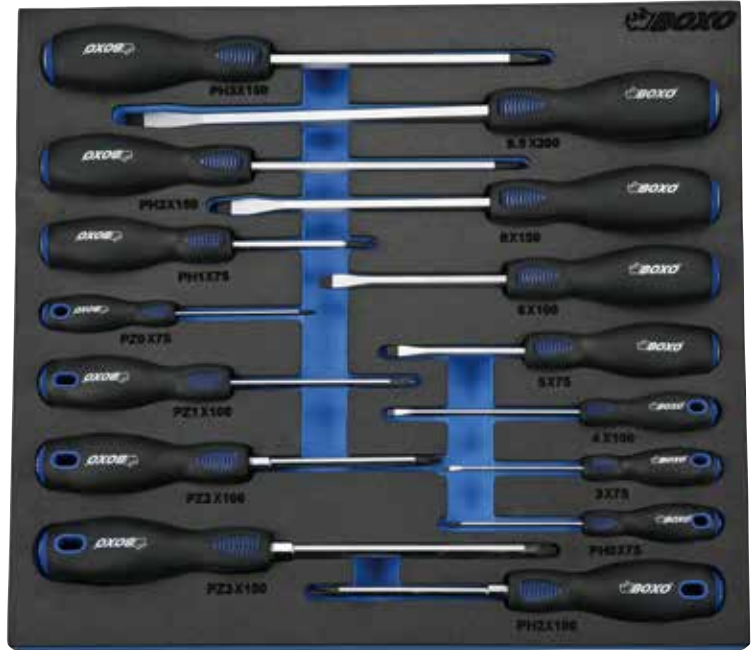

BX073

3/3 1/2"

1/2" Air impact wrench with impact socket set and torque wrench 34pc



- 1/2" Composite air impact wrench
- 1/2" Torque Wrench 40-200 Nm
- 1/2" Swivel handle w/ Frosty Finishing 460 mm
- Torque E-Bars 90, 100, 110, 120, 135 Nm
- 18" Go through pry bar
- 1/2" Impact sockets (6Pt) 8, 9, 10, 11, 12, 13, 14, 15, 16, 17, 18, 19, 21, 22, 24 mm
- 1/2" Deep impact sockets (6Pt) 17, 19, 21, 22, 24 mm
- 1/2" Wheel impact sockets 17, 19, 21 mm
- 1/2" Impact universal joint
- 1/2" Impact extension bar 125 mm

Cr-Mo

6pt

60

Length	569 mm
Width	379 mm



POWER TOOLS

AIR TOOLS

TOOL STORAGE

HAND TOOLS

WORKSHOP EQUIPMENT

SPECIALIST VEHICLE TOOLS

BXM20-M15

1/4" Socket set 15pc



- 1/4" Sockets (6Pt) 4, 4.5, 5, 5.5, 6, 7, 8, 9, 10, 11, 12, 13 mm
- 1/4" Extension bar 75 mm
- 1/4" Bit coupler
- 1/4" Reversible ratchet



1/4"

Cr-V

72

6Pt

U-BX140052

1/4" Socket set 52pc



- 1/4" Sockets 4, 5, 6, 7, 8, 9, 10, 11, 12, 13 mm
- 1/4" Deep sockets 4, 5, 6, 7, 8, 9, 10, 12, 13 mm
- 1/4" Bit sockets
H3, H4, H5, H6, H7, H8
SL4, SL5.5, SL6
PH1, PH2, PH3
PZ1, PZ2, PZ3
M5, M6, M8
T8, T10, T15, T20, T25, T27, T30, T40
- 1/4" Extension bar 50, 100 mm
- 1/4" Spinner handle
- 1/4" Reversible ratchet
- 1/4" Universal joint
- 1/4" Magnetic adapter
- 1/4" Bit coupler



1/4"

Cr-V

72

6Pt

XZN

Star

Star

Star

Star

Star

BMC

MET-0325

Socket set 37pc



1/4" Description:

- MET-1490 Ratchet
- MET-1492 Universal Joint
- MET-1493 Extension 50 mm
- MET-1494 1/4" Male & 3/8" female adapter
- MET-1495 Spinner handle
- MET-1497 T-handle
- MET-1498 Bit holder
- MET-1499 Extension 100 mm wobble

1/4" Sockets:

- 5 mm - 3/16"
- 6 mm - 1/4"
- 7 mm - 9/32"
- 8 mm - 5/16"
- 9 mm - 11/32"
- 10 mm - 3/8"
- 11 mm - 7/16"
- 12 mm - 15/32"

1/4" Bit sockets:

- SL4, SL4.5, SL5.5, SL6.5
- PZ1, PZ2
- PH0, PH1, PH2, PH3
- HX2.5, HX3, HX4, HX5, HX6
- TX10, TX15, TX20, TX25, TX27, TX30



1/4"

46CrV4

Star

Cr-V

40

Star

Star

Star

Star

Star

BMC

U-BX380036

3/8" Socket set 36pc



- 3/8" Sockets 8, 9, 10, 11, 12, 13, 14, 15, 16, 17, 18, 19, 20, 21, 22 mm
- 3/8" Deep sockets - 8, 9, 10, 11, 12, 13, 14, 15, 17, 19, 21 mm
- 3/8" Universal joint
- 3/8" Swivel handle 250 mm
- 3/8" Spark plug socket 16 mm
- 3/8" Extension bar 150, 250 mm
- Reversible ratchet
- Bit coupler
- Magnetic adapter
- 3/8" x 1/4" Adapter



3/8"



POWER TOOLS

AIR TOOLS

U-BX120030

1/2" Socket set 30pc



- 1/2" Sockets 10, 11, 12, 13, 14, 15, 16, 17, 18, 19, 20, 21, 22, 24, 27, 30, 32 mm
- 1/2" Deep sockets 17, 19, 21 mm
- 1/2" Spark plug socket 16, 21 mm
- 1/2" Extension bar 125, 250 mm
- 1/2" Universal joint
- 1/2" Swivel handle 380 mm
- Reversible ratchet
- Bit coupler
- Magnetic adapter
- 1/2" x 3/8" Adapter



1/2"



TOOL STORAGE

HAND TOOLS

MET-0427

Socket set 26pc



1/2" Description:

- MET-1290 Ratchet
- MET-1291 Extension bar 250 mm
- MET-1292 Spark plug socket 16 mm & 5/8"
- MET-1293 Spark plug socket 21 mm & 13/16"
- MET-1294 T-handle
- MET-1296 Universal joint
- MET-1299 Extension bar 125 mm wobble

1/2" Sockets:

- 10 mm - 3/8"
- 11 mm - 7/16"
- 12 mm - 15/32"
- 13 mm - 1/2"
- 14 mm - 9/16"
- 15 mm - 19/32"
- 16 mm - 5/8"
- 17 mm - 11/16"
- 18 mm - 23/32"
- 19 mm - 3/4"
- 20/21 mm - 13/16"
- 22 mm - 7/8"
- 23 mm - 29/32"
- 24 mm - 15/16"
- 25 mm - 1"
- 26/27 mm - 1 1/16"
- 28 mm - 1 1/8"
- 29/30 mm - 1 3/16"
- 31/32 mm - 1 1/4"



1/2"



WORKSHOP EQUIPMENT

SPECIALIST VEHICLE TOOLS

BX340021

3/4"

3/4" Socket set 21pc



3/4" Sockets:

- 19, 21, 22, 23, 24, 26, 27, 29, 30, 32, 35, 36, 38, 41, 46, 50 mm
- 3/4" Extension bar 100, 200, 410 mm
- 3/4" Reversible ratchet
- 3/4" Sliding T-handle 450 mm



BMC

Cr-V

72

6Pt

MET-0300

1/4" 3/8"

Socket set 25pc



3/8" Description:

- MET-1390 Ratchet 38 T
- MET-1392 Extension bar 150 mm wobble
- MET-1394 Universal joint
- MET-1395 Spark plug socket 16 mm & 5/8"
- MET-1396 Spark plug socket 21 mm & 13/16"

1/4" Description:

- MET-1491 Fingerlight ratchet 40 T
- MET-1492 Universal joint
- MET-1493 Extension bar 50 mm
- MET-1494 1/4" Male & 3/8" female adapter
- MET-1495 Spinner handle

1/4" Sockets:

- 5 mm - 3/16", 6 mm - 1/4", 7 mm - 9/32", 8 mm - 5/16", 9 mm - 11/32", 10 mm - 3/8", 11 mm - 7/16", 12 mm - 15/32"



3/8" Sockets:

- 13 mm - 1/2", 14 mm - 9/16", 16 mm - 5/8", 17 mm - 11/16", 19 mm - 3/4", 20/21 mm - 13/16", 22 mm - 7/8"



BMC

38

40

46CrV4

MET-0450

1/2"

Combination set 30pc



1/2" Description:

- MET-1290 Ratchet with 40 T
- MET-1293 Spark plug socket 21 mm & 13/16"
- MET-1295 Breaker bar 410 mm
- MET-1296 Universal joint
- MET-1299 Extension bar 125 mm wobble

1/2" Sockets:

- 10 mm - 3/8", 11 mm - 7/16", 12 mm - 15/32", 13 mm - 1/2", 14 mm - 9/16", 15 mm - 19/32", 16 mm - 5/8", 17 mm - 11/16", 18 mm - 23/32", 19 mm - 3/4", 20/21 mm - 13/16", 22/23 mm - 7/8", 24 mm - 15/16", 25 mm - 1", 26/27 mm - 1 1/16", 28 mm - 1 1/8", 29/30 mm - 1 3/16", 31/32 mm - 1 1/4"

Combination spanners:

- 11 mm - 7/16", 12 mm - 15/32", 13 mm - 1/2", 14 mm - 9/16", 17 mm - 11/16", 19 mm - 3/4", 22/23 mm - 7/8"



BMC

40

46CrV4

MET-0625

Combination set 37pc



3/8" Description:

- MET-1390 Ratchet with 38 T
- MET-1391 Extension bar 75 mm
- MET-1393 Extension bar 150 mm
- MET-1394 Universal joint
- MET-1395 Spark plug socket 16 mm & 5/8"
- MET-1396 Spark plug socket 21 mm & 13/16"
- MET-1399 Extension bar 40 mm wobble

1/4" Description:

- MET-1494 1/4" Male & 3/8" female adapter
- MET-1495 Spinner handle

1/4" Sockets:

- 5 mm - 3/16"
- 6 mm - 1/4"
- 7 mm - 9/32"
- 8 mm - 5/16"
- 9 mm - 11/32"
- 10 mm - 3/8"

3/8" Sockets:

- 10 mm - 3/8"
- 11 mm - 7/16"
- 12 mm - 15/32"
- 13 mm - 1/2"
- 14 mm - 9/16"
- 16 mm - 5/8"
- 17 mm - 11/16"
- 19 mm - 3/4"

3/8" Deep sockets:

- 10 mm - 3/8"
- 11 mm - 7/16"
- 12 mm - 15/32"
- 13 mm - 1/2"
- 14 mm - 9/16"
- 17 mm - 11/16"
- 19 mm - 3/4"

Combination spanners:

- 10 mm - 3/8"
- 11 mm - 7/16"
- 12 mm - 15/32"
- 13 mm - 1/2"
- 14 mm - 9/16"
- 16 mm - 5/8"
- 17 mm - 11/16"
- 19 mm - 3/4"



1/4" 3/8"



MET-0650

Combination set 50pc



1/2" Description:

- MET-1288 Extension bar 75 mm wobble
- MET-1290 Ratchet 40 T
- MET-1291 Extension bar 250 mm
- MET-1294 T-handle
- MET-1295 Breaker bar 410 mm
- MET-1297 Extension bar 125 mm

3/8" Description:

- MET-1387 Extension bar 125 mm
- MET-1390 Ratchet 38 T
- MET-1391 Extension bar 75 mm
- MET-1394 Universal joint
- MET-1395 Spark plug socket 16 mm & 5/8"
- MET-1396 Spark plug socket 21 mm & 13/16"
- MET-1399 Extension bar 40 mm wobble

1/4" Description:

- MET-1494 1/4" Male & 3/8" female adapter
- MET-1495 Spinner handle

1/4" Sockets:

- 5 mm - 3/16", 6 mm - 1/4", 7 mm - 9/32", 8 mm - 5/16", 9 mm - 11/32", 10 mm - 3/8"

3/8" Sockets:

- 10 mm - 3/8", 11 mm - 7/16", 12 mm - 15/32", 13 mm - 1/2", 14 mm - 9/16", 16 mm - 5/8", 17 mm - 11/16"

3/8" Deep sockets:

- 10 mm - 3/8", 11 mm - 7/16", 12 mm - 15/32", 13 mm - 1/2", 14 mm - 9/16", 16 mm - 5/8", 17 mm - 11/16"



1/4" 3/8" 1/2"



POWER TOOLS

AIR TOOLS

TOOL STORAGE

HAND TOOLS

WORKSHOP EQUIPMENT

SPECIALIST VEHICLE TOOLS

MET-0559

1/4" 3/8"

Combination set 59pc



3/8" Description:

- MET-1388 Extension bar 75 mm wobble
- MET-1390 Ratchet 38 T
- MET-1393 Extension bar 150 mm
- MET-1394 Universal joint
- MET-1396 Sparkplug socket 21 mm & 13/16"

1/4" Description:

- MET-1488 Extension bar 75 mm
- MET-1491 Fingertight ratchet 40 T
- MET-1494 1/4" Male & 3/8" female adapter
- MET-1495 Spinner handle

Bits sockets:

- SL4.0, SL4.5, SL6.5 mm
- PZ1, PZ2, PZ3, PH1, PH2, PH3, TX10, TX15, TX25, TX27, TX30

1/4" Sockets:

- 5 mm - 3/16", 6 mm - 1/4", 7 mm - 9/32", 8 mm - 5/16", 9 mm - 11/32", 10 mm - 3/8", 11 mm - 7/16", 12 mm - 15/32", 13 mm - 1/2"

3/8", Sockets:

- 10 mm - 3/8", 11 mm - 7/16", 12 mm - 15/32", 13 mm - 1/2", 14 mm - 9/16", 15 mm - 19/32", 16 mm - 5/8", 17 mm - 11/16", 18 mm - 23/32", 19 mm - 3/4", 20/21 mm - 13/16", 22 mm - 7/8"

3/8" Deep sockets:

- 10 mm - 3/8", 11 mm - 7/16", 12 mm - 15/32", 13 mm - 1/2", 14 mm - 9/16", 16 mm - 5/8", 17 mm - 11/16"

Combination Spanners:

- 10 mm - 3/8", 12 mm - 15/32", 13 mm - 1/2", 14 mm - 9/16", 16 mm - 5/8", 17 mm - 11/16", 18 mm - 23/32", 19 mm - 3/4"



MET-0076

1/4" 3/8" 1/2"

Combination set 76pc



1/2" Description:

- MET-1290 Ratchet 40 T
- MET-1291 Extension bar 250 mm
- MET-1294 T-handle

3/8" Description:

- MET-1390 Ratchet 38 T
- MET-1391 Extension bar 75 mm
- MET-1394 Universal joint
- MET-1395 Spark plug socket 16 mm & 5/8"
- MET-1396 Spark plug socket 21 mm & 13/16"

1/4" Description:

- MET-1491 Fingerlight ratchet 40 T
- MET-1492 Universal joint
- MET-1493 Extension bar 50 mm
- MET-1494 1/4" Male & 3/8" female adapter
- MET-1495 Spinner handle

1/4" Sockets:

- 5 mm - 3/16"
- 6 mm - 1/4"
- 7 mm - 9/32"
- 8 mm - 5/16"
- 9 mm - 11/32"
- 10 mm - 3/8"
- 11 mm - 7/16"
- 12 mm - 15/32"
- 13 mm - 1/2"

1/4" Deep sockets:

- 5 mm - 3/16"
- 6 mm - 1/4"



- 7 mm - 9/32"
- 8 mm - 5/16"
- 9 mm - 11/32"
- 10 mm - 3/8"
- 11 mm - 7/16"
- 12 mm - 15/32"

3/8" Sockets:

- 10 mm - 3/8"
- 11 mm - 7/16"
- 12 mm - 15/32"
- 13 mm - 1/2"
- 14 mm - 9/16"
- 15 mm - 19/32"
- 16 mm - 5/8"
- 17 mm - 11/16"
- 19 mm - 3/4"
- 20/21 mm - 13/16"
- 22 mm - 7/8"

3/8" Deep sockets:

- 10 mm - 3/8"
- 11 mm - 7/16"
- 13 mm - 1/2"
- 14 mm - 9/16"
- 17 mm - 11/16"



- 19 mm - 3/4"
- 22 mm - 7/8"

1/2" Sockets:

- 10 mm - 3/8"
- 11 mm - 7/16"
- 12 mm - 15/32"
- 13 mm - 1/2"
- 14 mm - 9/16"
- 15 mm - 19/32"
- 16 mm - 5/8"
- 17 mm - 11/16"
- 18 mm - 23/32"
- 19 mm - 3/4"
- 20/21 mm - 13/16"
- 22 mm - 7/8"
- 24 mm - 15/16"

- 25 mm - 1"
- 26/27 mm - 1 1/16"
- 29/30 mm - 1 3/16"
- 31/32 mm - 1 1/4"

Combination Spanners:

- 10 mm - 3/8"
- 11 mm - 7/16"
- 12 mm - 15/32"
- 13 mm - 1/2"
- 14 mm - 9/16"
- 15 mm - 19/32"
- 16 mm - 5/8"
- 17 mm - 11/16"
- 18 mm - 23/32"
- 19 mm - 3/4"
- 20/21 mm - 13/16"



MET-0563

1/4" 3/8"

Combination set 63pc



3/8" Description:

- MET-1390 Ratchet 38 T
- MET-1393 Extension bar 150 mm
- MET-1394 Universal joint
- MET-1396 Spark plug socket 21 mm & 13/16"

1/4" Description:

- MET-1491 Fingerlight ratchet 40 T
- MET-1493 Extension bar 50 mm
- MET-1494 1/4" Male & 3/8" female adapter
- MET-1495 Spinner handle
- MET-1498 Bit holder

Bit sockets:

SL4.0, SL4.5, SL5.5, SL6.5PZ1, PZ2, PZ3PH0, PH1, PH2, PH3HX2.5, HX3.0, HX4.0, HX5.0, HX6.0TX10, TX15, TX20, TX25, TX27, TX30

1/4" Sockets:

5 mm - 3/16", 6 mm - 1/4", 7 mm - 9/32", 8 mm - 5/16", 9 mm - 11/32", 10 mm - 3/8", 11 mm - 7/16", 12 mm - 15/32", 13 mm - 1/2"

3/8" Sockets:

7 mm - 9/32", 8 mm - 5/16", 9 mm - 11/32", 10 mm - 3/8", 11 mm - 7/16", 12 mm - 15/32", 13 mm - 1/2", 14 mm - 9/16", 15 mm - 19/32", 16 mm - 5/8", 17 mm - 11/16", 18 mm - 23/32", 19 mm - 3/4", 20/21 mm - 13/16"

Combination spanners:

9 mm - 11/32", 10 mm - 3/8", 11 mm - 7/16", 12 mm - 15/32", 13 mm - 1/2", 14 mm - 9/16", 15 mm - 19/32", 16 mm - 5/8", 17 mm - 11/16", 18 mm - 23/32"



U-BX14120122

1/4" 1/2"

1/4" & 1/2" Socket set 122pc



- 1/4" Sockets 4, 4.5, 5, 5.5, 6, 7, 8, 9, 10, 11, 12, 13 mm
- 1/4" Deep sockets 4, 5, 6, 7, 8, 9, 10, 11, 12, 13 mm
- 1/4" Bit sockets H3, H4, H5, H6, H7 & H8, SL4, SL5.5, SL6, PH1, PH2, PH3, PZ1, PZ2, PZ3, M5, M6, M8, T8, T10, T15, T20, T25, T27, T30, T40
- 1/4" Extension bar 50, 100 mm
- 1/4" Reversible ratchet
- 1/4" Universal joint
- Spinner handle
- 1/4" Sliding T-handle 115 mm
- Magnetic adapter
- Bit coupler
- 1/2" Sockets 10, 12, 13, 14, 15, 16, 17, 18, 19, 20, 21, 22, 23, 24, 27, 30, 32, 34 mm
- 1/2" Sockets 3/8", 7/16", 1/2", 9/16", 11/16", 3/4"
- 1/2" Deep sockets 13, 15, 17, 19 mm
- 1/2" Spark plug socket 16, 21 mm
- 1/2" Extension bar 125, 250 mm
- 1/2" Magnetic adapter
- Universal joint
- Reversible ratchet
- 1/2" x 3/8" Adapter
- Bit coupler

Combination wrenches

7, 8, 10, 11, 12, 13, 14, 15, 17, 18, 19, 21, 22 mm

3/8" Bit adapter

5/16" Bits Hex, H8, H10, H12, H14, TP40, TP45, TP50, TP55, PH, PH3, PH4, PZ3, PZ4

Slotted

8, 10, 12 mm



POWER TOOLS

AIR TOOLS

TOOL STORAGE

HAND TOOLS

WORKSHOP EQUIPMENT

SPECIALIST VEHICLE TOOLS

<p>MET-0220 1/4"</p> <p>1/4" Socket rail set 9pc </p> <p>Contents:</p> <ul style="list-style-type: none"> 5 mm - 3/16" 6 mm - 1/4" 7 mm - 9/32" 8 mm - 5/16" 9 mm - 11/32" 10 mm - 3/8" 11 mm - 7/16" 12 mm - 15/32" 13 mm - 1/2" <p> 46CrV4</p> 	<p>MET-0230 1/4"</p> <p>1/4" Deep socket rail set 9pc </p> <p>Contents:</p> <ul style="list-style-type: none"> 5 mm - 3/16" 6 mm - 1/4" 7 mm - 9/32" 8 mm - 5/16" 9 mm - 11/32" 10 mm - 3/8" 11 mm - 7/16" 12 mm - 15/32" 13 mm - 1/2" <p> 46CrV4</p> 	<p>B-1407R 1/4"</p> <p>1/4" TX-E socket rail set  7pc</p> <p>Contents: E4, E5, E6, E7, E8, E10, E11</p> <p> Cr-V</p> <p> DIN 3124</p> 
<p>SK2060-13AR 1/4"</p> <p>1/4" Socket rail set 13pc </p> <p>Contents: 4, 4.5, 5, 5.5, 6, 7, 8, 9, 10, 11, 12, 13, 14 mm</p> <p> 6Pt</p> <p> Cr-V</p> <p> DIN 3124</p> 	<p>SK2060L-13AR 1/4"</p> <p>1/4" Deep socket rail set 13pc </p> <p>Contents: 4, 4.5, 5, 5.5, 6, 7, 8, 9, 10, 11, 12, 13, 14 mm</p> <p> 6Pt</p> <p> Cr-V</p> <p> DIN 3124</p> 	<p>B-1438R 1/4"</p> <p>1/4" & 3/8" TX-E socket rail set 11pc </p> <p>Contents: E4, E5, E6, E7, E8, E10, E11, E12, E14, E16, E18</p> <p> Star</p> <p> Cr-V</p> <p> DIN 3120</p> 
<p>B-TR08 1/4"</p> <p>1/4", 3/8" & 1/2" Mixed TX-E socket rail set 8pc </p> <p>Contents:</p> <ul style="list-style-type: none"> 1/4" Sockets E4, E5 3/8" Sockets E10, E11, E12, E14 1/2" Sockets E14, E16 <p> Star</p> <p> Cr-V</p> <p> DIN 3120</p> 	<p>MET-0321 3/8"</p> <p>3/8" Socket rail set 8pc </p> <p>Contents:</p> <ul style="list-style-type: none"> 10 mm - 3/8" 11 mm - 7/16" 12 mm - 15/32" 13 mm - 1/2" 14 mm - 9/16" 16 mm - 5/8" 17 mm - 11/16" 19 mm - 3/4" <p> 46CrV4</p> 	<p>MET-0320 3/8"</p> <p>3/8" Socket rail set 12pc </p> <p>Contents:</p> <ul style="list-style-type: none"> 10 mm - 3/8" 11 mm - 7/16" 12 mm - 15/32" 13 mm - 1/2" 14 mm - 9/16" 15 mm - 19/32" 16 mm - 2/8" 17 mm - 11/16" 18 mm - 23/32" 19 mm - 3/4" 20/21 mm - 13/16" 22 mm - 7/8" <p> 46CrV4</p> 

MET-0331

3/8"

3/8" Deep socket rail set 8pc



Contents:

- 10 mm - 3/8"
- 11 mm - 7/16"
- 12 mm - 15/32"
- 13 mm - 1/2"
- 14 mm - 9/16"
- 16 mm - 5/8"
- 17 mm - 11/16"
- 19 mm - 3/4"



MET-0330

3/8"

3/8" Deep socket rail set 12pc



Contents:

- 10 mm - 3/8"
- 11 mm - 7/16"
- 12 mm - 15/32"
- 13 mm - 1/2"
- 14 mm - 9/16"
- 15 mm - 19/32"
- 16 mm - 5/8"
- 17 mm - 11/16"
- 18 mm - 23/32"
- 19 mm - 3/4"
- 20/21 mm - 13/16"
- 22 mm - 7/8"



SK3060-13AR

3/8"

3/8" Socket rail set 13pc



Contents:

7, 8, 9, 10, 11, 12, 13, 14, 15, 16, 17, 19, 21 mm



SK3060L-13AR

3/8"

3/8" Deep socket rail set 13pc



Contents:

7, 8, 9, 10, 11, 12, 13, 14, 15, 16, 17, 19, 21 mm



B-H3807R

3/8"

3/8" Hex socket rail set 8pc



Contents:

3, 4, 6, 7, 8, 10, 12 mm



B-T3808R

3/8"

3/8" TX bit socket rail set 8pc



Contents:

T15, T20, T25, T27, T30, T40, T45, T50



B-3806R

3/8"

3/8" TX-E socket rail set 6pc



Contents:

E6, E8, E10, E12, E14, E16



B-3812R

3/8"

3/8" TX-E socket rail set 12pc



Contents:

E4, E5, E6, E7, E8, E10, E11, E12, E14, E16, E18, E20



POWER TOOLS





























AIR TOOLS

TOOL STORAGE

HAND TOOLS

WORKSHOP EQUIPMENT

SPECIALIST VEHICLE TOOLS

<p>MET-0431 1/2"</p> <p>1/2" Socket rail set 8pc</p> <p>METRINCH IF THIS CAN'T DO IT, NO TOOL CAN</p> <p>Contents:</p> <ul style="list-style-type: none"> 10 mm - 3/8" 11 mm - 7/16" 12 mm - 15/32" 13 mm - 1/2" 14 mm - 9/16" 16 mm - 5/8" 17 mm - 11/16" 19 mm - 3/4" <p> 46CrV4</p> 	<p>MET-0430 1/2"</p> <p>1/2" Socket rail set 10pc</p> <p>METRINCH IF THIS CAN'T DO IT, NO TOOL CAN</p> <p>Contents:</p> <ul style="list-style-type: none"> 10 mm - 3/8" 11 mm - 7/16" 12 mm - 15/32" 13 mm - 1/2" 14 mm - 9/16" 16 mm - 5/8" 17 mm - 11/16" 19 mm - 3/4" 22 mm - 7/8" 24 mm - 15/16" <p> 46CrV4</p> 	<p>MET-0441 1/2"</p> <p>1/2" Deep socket rail set 8pc</p> <p>METRINCH IF THIS CAN'T DO IT, NO TOOL CAN</p> <p>Contents:</p> <ul style="list-style-type: none"> 10 mm - 3/8" 11 mm - 7/16" 12 mm - 15/32" 13 mm - 1/2" 14 mm - 9/16" 16 mm - 5/8" 17 mm - 11/16" 19 mm - 3/4" <p> 46CrV4</p> 
<p>MET-0440 1/2"</p> <p>1/2" Deep socket rail set 10pc</p> <p>METRINCH IF THIS CAN'T DO IT, NO TOOL CAN</p> <p>Contents:</p> <ul style="list-style-type: none"> 10 mm - 3/8" 11 mm - 7/16" 12 mm - 15/32" 13 mm - 1/2" 14 mm - 9/16" 16 mm - 5/8" 17 mm - 11/16" 19 mm - 3/4" 22 mm - 7/8" 24 mm - 15/16" <p> 46CrV4</p> 	<p>SK4060-11AR 1/2"</p> <p>1/2" Socket rail set 11pc</p> <p>BOXO tools for life</p> <p>Contents: 10, 11, 12, 13, 14, 15, 16, 17, 19, 21, 22 mm</p> <p> 6Pt</p> <p> Cr-V</p> <p> DIN 3124</p> 	<p>SK4060L-11AR 1/2"</p> <p>1/2" Deep socket rail set 11pc</p> <p>BOXO tools for life</p> <p>Contents: 10, 11, 12, 13, 14, 15, 16, 17, 19, 21, 22 mm</p> <p> 6Pt</p> <p> Cr-V</p> <p> DIN 3124</p> 
<p>B-H1209R 1/2"</p> <p>1/2" Hex bit socket rail set 9pc</p> <p>BOXO tools for life</p> <p>Contents: 5, 6, 7, 8, 9, 10, 12, 14, 17 mm</p> <p> Hex</p> <p> Cr-V</p> <p> DIN 3120</p> 	<p>B-T1209R 1/2"</p> <p>1/2" TX Bit socket rail set 9pc</p> <p>BOXO tools for life</p> <p>Contents: T20, T25, T27, T30, T40, T45, T50, T55, T60</p> <p> TX</p> <p> Cr-V</p> <p> DIN 3120</p> 	<p>B-1205R 1/2"</p> <p>1/2" TX-E socket rail set 5 pc</p> <p>BOXO tools for life</p> <p>Contents: E16, E18, E20, E22, E24</p> <p> TX-E</p> <p> Cr-V</p> <p> DIN 3120</p> 

B-1209R

1/2"

1/2" TX-E socket rail set 9pc



Contents:

E10, E11, E12, E14, E16, E18, E20, E22, E24



Cr-V

DIN 3120

X-MET-CLIP14

1/4"

X-MET-CLIP38

3/8"

X-MET-CLIP12

1/2"

1/4" Metal clip



3/8" Metal clip



1/2" Metal clip



P-AR-C14

1/4"

P-AR-C38

3/8"

P-AR-C12

1/2"

1/4" Plastic clip



3/8" Plastic clip



1/2" Plastic clip



POWER TOOLS

AIR TOOLS

TOOL STORAGE

HAND TOOLS

WORKSHOP EQUIPMENT

SPECIALIST VEHICLE TOOLS

X-MET-CR152MM

Metal rail 152 mm



X-MET-CR203MM

Metal rail 203 mm



X-MET-CR213MM

Metal rail 213 mm



X-MET-CR230MM

Metal rail 230 mm



X-MET-CR280MM

Metal rail 280 mm



P-AR160

Aluminium rail 160 mm



P-AR215

Aluminium rail 215 mm



P-AR305

Aluminium rail 305 mm



METRINCH[®]
 IF THIS CAN'T DO IT, NO TOOL CAN

 **BOXO**[®]
tools for life



POWER TOOLS

AIR TOOLS

TOOL STORAGE

HAND TOOLS

WORKSHOP EQUIPMENT

SPECIALIST VEHICLE TOOLS

MET-14-SOCKET-SERIE

1/4"

1/4" Sockets - metric and inch



	Size (mm)
MET-1404	4 mm - 5/32"
MET-1405	5 mm - 3/16"
MET-1406	6 mm - 1/4"
MET-1407	7 mm - 9/32"
MET-1408	8 mm - 5/16"
MET-1409	9 mm - 11/32"
MET-1410	10 mm - 3/8"
MET-1411	11 mm - 7/16"
MET-1412	12 mm - 15/32"
MET-1413	13 mm - 1/2"



MET-14-DEEP-SOCKET-SERIE

1/4"

1/4" Deep sockets - metric and inch



	Size (mm)
MET-1454	4 mm - 5/32"
MET-1455	5 mm - 3/16"
MET-1456	6 mm - 1/4"
MET-1457	7 mm - 9/32"
MET-1458	8 mm - 5/16"
MET-1459	9 mm - 11/32"
MET-1460	10 mm - 3/8"
MET-1461	11 mm - 7/16"
MET-1462	12 mm - 15/32"
MET-1463	13 mm - 1/2"



SK2060-SERIE

1/4"

1/4" Sockets - 6Pt



	Size (mm)	L (mm)	D1 (mm)	D2 (mm)	T (mm)
SK2060-004	4	25	11.8	6.8	3.6
SK2060-005	5	25	11.8	8	4.2
SK2060-006	6	25	11.8	9.3	4.8
SK2060-007	7	25	11.8	10.8	5.4
SK2060-008	8	25	11.8	11.8	5.4
SK2060-009	9	25	12.8	12.8	6
SK2060-010	10	25	13.8	13.8	7
SK2060-011	11	25	15.8	15.8	8
SK2060-012	12	25	16.8	16.8	8
SK2060-013	13	25	17.8	17.8	8
SK2060-014	14	25	19.8	19.8	10
SK2060-045	4.5	25	11.8	7.4	3.6
SK2060-055	5.5	25	11.8	8.7	4.2

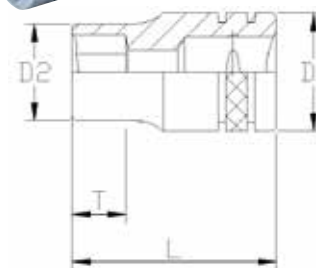

SK2060-L-SERIE

1/4"

1/4" Sockets long - 6Pt



	Size (mm)	L (mm)	D1 (mm)	D2 (mm)	T (mm)
SK2060-004L	4	50	11.8	6.8	5
SK2060-005L	5	50	11.8	8	5.5
SK2060-006L	6	50	11.8	9.3	6
SK2060-007L	7	50	11.8	10.8	10.5
SK2060-008L	8	50	11.8	11.8	10.5
SK2060-009L	9	50	12.8	12.8	11.5
SK2060-010L	10	50	13.8	13.8	13
SK2060-011L	11	50	15.8	15.8	14
SK2060-012L	12	50	16.8	16.8	15
SK2060-013L	13	50	17.8	17.8	17
SK2060-014L	14	50	19.8	19.8	19
SK2060-045L	4.5	50	11.8	7.4	5
SK2060-055L	5.5	50	11.8	8.7	5.5

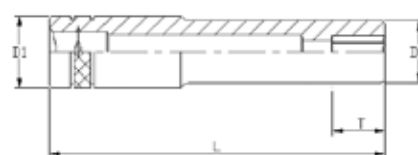

SK2060-E-SERIE

1/4"

1/4" Sockets - TX-E



	Size	L (mm)	D1 (mm)	D2 (mm)	T (mm)
SK2060-004E	E4	25	11.8	6.1	4.2
SK2060-005E	E5	25	11.8	6.9	4.2
SK2060-006E	E6	25	11.8	8	4.2
SK2060-007E	E7	25	11.8	8.8	4.2
SK2060-008E	E8	25	11.8	10	4.8
SK2060-010E	E10	25	13.7	12	5.4
SK2060-011E	E11	25	13.7	12.7	6

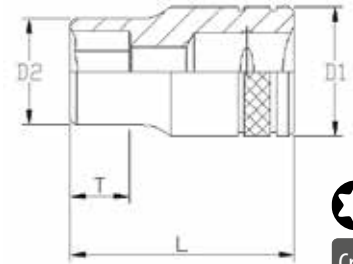

Cr-V

DIN 3120

SB20-T-SERIE

1/4"

1/4" Bit sockets - TX



	Size	L (mm)	D (mm)
SB20-T0837	T8	37	11.9
SB20-T1037	T10	37	11.9
SB20-T1537	T15	37	11.9
SB20-T2037	T20	37	11.9
SB20-T2537	T25	37	11.9
SB20-T2737	T27	37	11.9
SB20-T3037	T30	37	11.9
SB20-T4037	T40	37	11.9

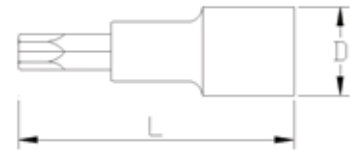

Cr-V

DIN 3120

SB20-M0537

1/4"

1/4 Triple square bit socket M5



	Size	L (mm)	D (mm)
SB20-M0537	M5	37	11.9
SB20-M0837	M8	37	11.9
SB20-M0637	M6	37	11.9

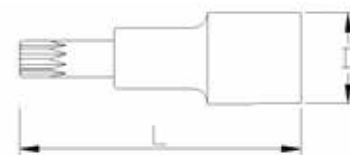

Cr-V

DIN 3120

SB20-H-SERIE

1/4"

1/4" Bit sockets - Hex



	Size (mm)	L (mm)	D (mm)
SB20-H0337	3	37	11.9
SB20-H0437	4	37	11.9
SB20-H0537	5	37	11.9
SB20-H0637	6	37	11.9
SB20-H0737	7	37	11.9
SB20-H0837	8	37	11.9
SB20-H2537	2.5	37	11.9

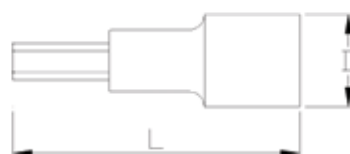

Cr-V

DIN 3120

POWER TOOLS

AIR TOOLS

TOOL STORAGE

HAND TOOLS

WORKSHOP EQUIPMENT

SPECIALIST VEHICLE TOOLS

SB20-PH-SERIE

1/4"

1/4" Bit sockets - Philips



	Size	L (mm)	D (mm)
SB20-PH037	PH0	37	11.9
SB20-PH137	PH1	37	11.9
SB20-PH237	PH2	37	11.9
SB20-PH337	PH3	37	11.9
SB20-PH437	PH4	37	11.9

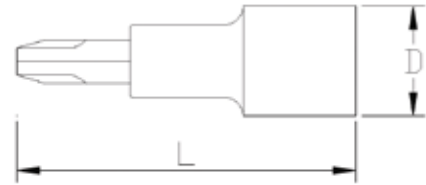

Cr-V

DIN 3120

SB20-PZ-SERIE

1/4"

1/4" Bit sockets - Pozi



	Size	L (mm)	D1 (mm)
SB20-PZ037	PZ0	37	11.9
SB20-PZ137	PZ1	37	11.9
SB20-PZ237	PZ2	37	11.9
SB20-PZ337	PZ3	37	11.9

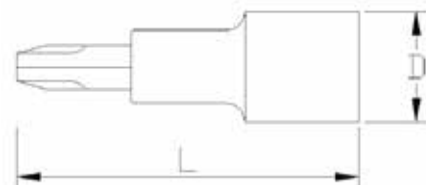

Cr-V

DIN 3120

SB20-SL-SERIE

1/4"

1/4" Bit sockets - Slotted



	Size (mm)	L (mm)	D (mm)
SB20-SL0337	3	37	11.9
SB20-SL0437	4	37	11.9
SB20-SL0637	4.5	37	11.9
SB20-SL0837	4.5	37	11.9
SB20-SL4537	6	37	11.9
SB20-SL5537	8	37	11.9

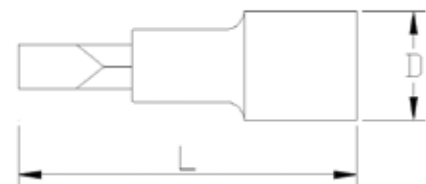

Cr-V

DIN 3120

3/8" SOCKETS

MET-13-SOCKET-SERIE

3/8"

3/8" Sockets - Metric and Inch



	Size
MET-1308	8 mm - 5/16"
MET-1309	9 mm - 11/32"
MET-1310	10 mm - 3/8"
MET-1311	11 mm - 7/16"
MET-1312	12 mm - 15/32"
MET-1313	13 mm - 1/2"
MET-1314	14 mm - 9/16"
MET-1315	15 mm - 19/32"
MET-1316	16 mm - 5/8"
MET-1317	17 mm - 11/16"
MET-1318	18 mm - 23/32"
MET-1319	19 mm - 3/4"
MET-1320	20 mm - 13/16"
MET-1322	22 mm - 7/8"



MET-13-DEEP-SOCKET-SERIE

3/8"

3/8" Deep sockets - Metric and Inch



	Size
MET-1350	10 mm - 3/8"
MET-1351	11 mm - 7/16"
MET-1352	12 mm - 15/32"
MET-1353	13 mm - 1/2"
MET-1354	14 mm - 9/16"
MET-1355	15 mm - 19/32"
MET-1356	16 mm - 5/8"
MET-1357	17 mm - 11/16"
MET-1358	18 mm - 23/32"
MET-1359	19 mm - 3/4"
MET-1360	20 mm - 13/16"
MET-1362	22 mm - 7/8"



SK3060-SERIE

3/8"

3/8" Sockets - 6Pt

	Size (mm)	L (mm)	D1 (mm)	D2 (mm)	T (mm)
SK3060-006	6	28	16.8	10	6
SK3060-007	7	28	16.8	10.8	6
SK3060-008	8	28	16.8	12	6
SK3060-009	9	28	16.8	13.1	8
SK3060-010	10	28	16.8	14.7	8
SK3060-011	11	28	16.8	15.7	8
SK3060-012	12	28	15.7	16.8	8
SK3060-013	13	28	16.5	17.8	8
SK3060-014	14	28	17.5	19.8	11
SK3060-015	15	28	19	21.8	11
SK3060-016	16	28	19.5	21.8	12
SK3060-017	17	30	21.5	23.8	12
SK3060-018	18	30	23	25.8	12
SK3060-019	19	30	23.5	25.8	14
SK3060-020	20	30	25.5	27.8	14
SK3060-021	21	30	26.5	27.8	14
SK3060-022	22	30	28.5	29.8	14
SK3060-024	24	30	29	31.8	14

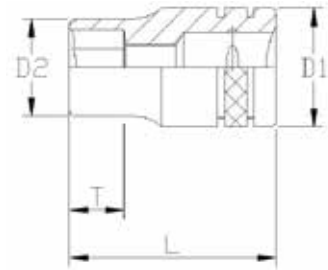

SK3060-L-SERIE

3/8"

3/8" Deep sockets - 6Pt

	Size (mm)	L (mm)	D1 (mm)	D2 (mm)	T (mm)
SK3060-006L	6	63	16.8	10	15
SK3060-007L	7	63	16.8	10.8	15
SK3060-008L	8	63	16.8	12	15
SK3060-009L	9	63	16.8	13.1	15
SK3060-010L	10	63	16.8	14.7	19
SK3060-011L	11	63	16.8	15.7	23
SK3060-012L	12	63	15.7	16.8	23
SK3060-013L	13	63	16.5	18.8	23
SK3060-014L	14	63	17.5	19.8	23
SK3060-015L	15	63	19	21.8	23
SK3060-016L	16	63	19.5	21.8	23
SK3060-017L	17	63	21.5	23.8	23
SK3060-018L	18	63	23	25.8	23
SK3060-019L	19	63	23.5	25.8	23
SK3060-020L	20	63	25	27.8	23
SK3060-021L	21	63	25.5	27.8	23
SK3060-022L	22	63	26.5	29.8	23
SK3060-024L	24	63	29	31.8	23

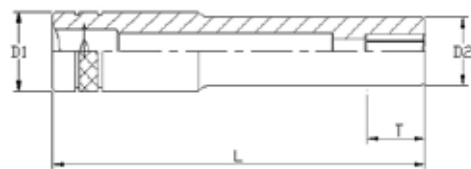

SK3122-SERIE

3/8"

3/8" Sockets - 12Pt



	Size (mm)	L (mm)	D1 (mm)	D2 (mm)	T (mm)
SK3122-006	6	28	16.8	10	6
SK3122-007	7	28	16.8	10.8	6
SK3122-008	8	28	16.8	12	6
SK3122-009	9	28	16.8	13.1	8
SK3122-010	10	28	16.8	14.7	8
SK3122-011	11	28	16.8	15.7	8
SK3122-012	12	28	15.7	16.8	8
SK3122-013	13	28	16.5	17.8	8
SK3122-014	14	28	17.5	19.8	11
SK3122-015	15	28	19	21.8	11
SK3122-016	16	28	19.5	21.8	12
SK3122-017	17	30	21.5	23.8	12
SK3122-018	18	30	23	25.8	12
SK3122-019	19	30	23.5	25.8	14
SK3122-020	20	30	25.5	27.8	14
SK3122-021	21	30	26.5	27.8	14
SK3122-022	22	30	28.5	29.8	14

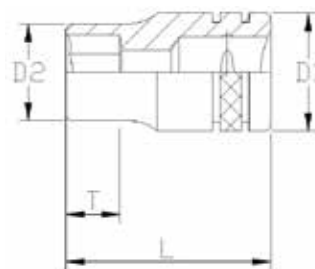

12pt

Cr-V

DIN 3124

SK3122-010L

3/8"

3/8" Deep socket - 12Pt 10 mm



	Size (mm)	L (mm)	D1 (mm)	D2 (mm)	T (mm)
SK3122-010L	10	63	16.8	14.7	23
SK3122-011L	10	63	16.8	14.7	19
SK3122-013L	13	63	16.5	18.8	23

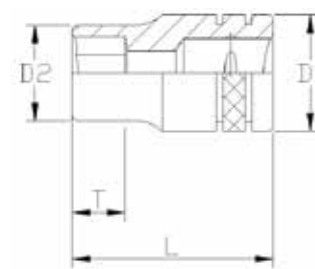

12pt

Cr-V

DIN 3124

SK3060-E-SERIE

3/8"

3/8" Sockets - TX-E



	Size (mm)	L (mm)	D1 (mm)	D2 (mm)	T (mm)
SK3060-004E	E4	28	16.8	6.5	6
SK3060-005E	E5	28	16.8	7	6
SK3060-006E	E6	28	16.8	8	6
SK3060-007E	E7	28	16.8	9	8
SK3060-008E	E8	28	16.8	10.5	8
SK3060-010E	E10	28	16.8	12	8
SK3060-011E	E11	28	16.8	13	8
SK3060-012E	E12	28	16.8	14	8
SK3060-014E	E14	28	17.8	16	11

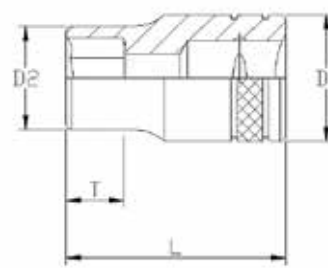

Cr-V

DIN 3120

SB30-T-SERIE

3/8"

3/8" Bit sockets - TX

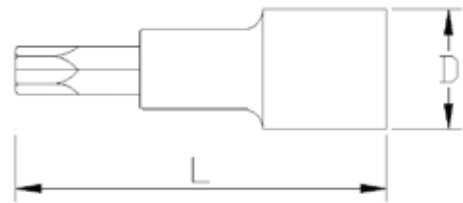

	Size	L (mm)	D (mm)
SB30-T1548	T15	48	17.9
SB30-T2048	T20	48	17.9
SB30-T2548	T25	48	17.9
SB30-T2748	T27	48	17.9
SB30-T3048	T30	48	17.9
SB30-T4048	T40	48	17.9
SB30-T4548	T45	48	17.9
SB30-T5048	T50	48	17.9
SB30-T5548	T55	48	17.9



Cr-V
DIN 3120

SB30-H-SERIE

3/8"

3/8" Bit sockets - Hex

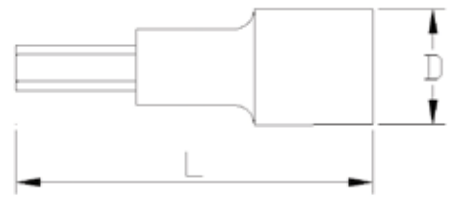

	Size (mm)	L (mm)	D (mm)
SB30-H0348	3	48	17.9
SB30-H0448	4	48	17.9
SB30-H0548	5	48	17.9
SB30-H0648	6	48	17.9
SB30-H0748	7	48	17.9
SB30-H0848	8	48	17.9
SB30-H1048	10	48	17.9



Cr-V
DIN 3120

SB30-PH-SERIE

3/8"

3/8" Bit sockets - Philips

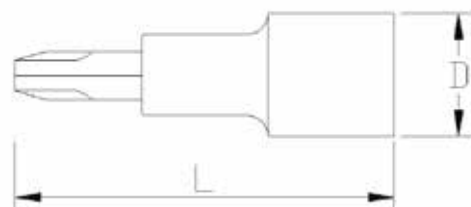

	Size	L (mm)	D (mm)
SB30-PH148	PH1	48	17.9
SB30-PH248	PH2	48	17.9
SB30-PH348	PH3	48	17.9



Cr-V
DIN 3120

POWER TOOLS

AIR TOOLS

TOOL STORAGE

HAND TOOLS

WORKSHOP EQUIPMENT

SPECIALIST VEHICLE TOOLS

SB30-PZ-SERIE

3/8"

3/8" Bit sockets - Pozi

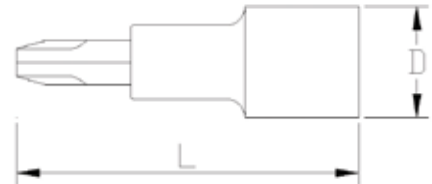

Cr-V

DIN 3120

	Size	L (mm)	D (mm)
SB30-PZ148	PZ1	48	17.9
SB30-PZ248	PZ2	48	17.9
SB30-PZ348	PZ3	48	17.9

SB30-SL-SERIE

3/8"

3/8" Bit sockets - Slotted

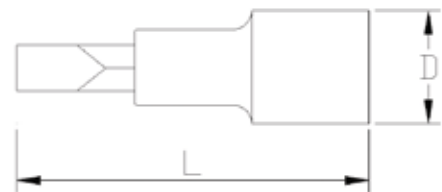

Cr-V

DIN 3120

	Size (mm)	L (mm)	D (mm)
SB30-SL0848	8	48	17.9
SB30-SL1048	10	48	17.9
SB30-SL5548	5.5	48	17.9
SB30-SL6548	6.5	48	17.9

MET-12-SOCKET-SERIE

1/2"

1/2" Sockets - Metric and Inch



	Size
MET-1210	10 mm - 3/8"
MET-1211	11 mm - 7/16"
MET-1212	12 mm - 15/32"
MET-1213	13 mm - 1/2"
MET-1214	14 mm - 9/16"
MET-1215	15 mm - 19/32"
MET-1216	16 mm - 5/8"
MET-1217	17 mm - 11/16"
MET-1218	18 mm - 23/32"
MET-1219	19 mm - 3/4"
MET-1220	20/21 mm - 13/16"
MET-1222	22 mm - 7/8"
MET-1223	23 mm - 29/32"
MET-1224	24 mm - 15/16"
MET-1225	25 mm - 1"
MET-1226	26/27 mm - 1 1/16"
MET-1228	28 mm - 1 1/8"
MET-1229	29/30 mm - 1 3/16"
MET-1231	31/32 mm - 1 1/4"

46CrV4

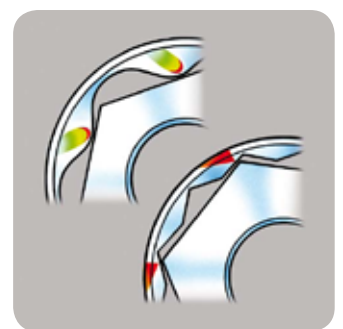

MET-12-DEEP-SOCKET-SERIE

1/2"

1/2" Deep sockets - Metric and Inch



	Size
MET-1250	10 mm - 3/8"
MET-1251	11 mm - 7/16"
MET-1252	12 mm - 15/32"
MET-1253	13 mm - 1/2"
MET-1254	14 mm - 9/16"
MET-1255	15 mm - 19/32"
MET-1256	16 mm - 5/8"
MET-1257	17 mm - 11/16"
MET-1258	18 mm - 23/32"
MET-1259	19 mm - 3/4"
MET-1260	20/21 mm - 13/16"
MET-1262	22 mm - 7/8"
MET-1263	23 mm - 29/32"
MET-1264	24 mm - 15/16"
MET-1265	25 mm - 1"
MET-1267	26/27 mm - 1 1/16"
MET-1268	28 mm - 1 1/8"
MET-1270	29/30 mm - 1 3/16"
MET-1272	31/32 mm - 1 1/4"

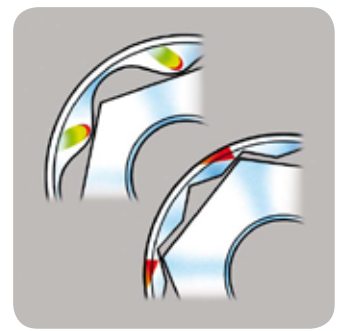

46CrV4

POWER TOOLS

AIR TOOLS

TOOL STORAGE

SK4060-SERIE

1/2"

1/2" Sockets - 6Pt



	Size (mm)	L (mm)	D1 (mm)	D2 (mm)	T (mm)
SK4060-008	8	38	21.8	13.2	9
SK4060-009	9	38	21.8	13.9	10
SK4060-010	10	38	21.8	15	10
SK4060-011	11	38	21.8	16.3	10
SK4060-012	12	38	21.8	17.6	10
SK4060-013	13	38	21.8	18.8	10
SK4060-014	14	38	21.8	20.4	10
SK4060-015	15	38	21.8	21	14
SK4060-016	16	38	23.3	22	14
SK4060-017	17	38	22	23.8	14
SK4060-018	18	38	23	25.8	14
SK4060-019	19	38	23.5	25.8	18
SK4060-020	20	38	24	27.8	18
SK4060-021	21	38	25	27.8	18
SK4060-022	22	38	26	29.8	18
SK4060-023	23	40	27	31.8	18
SK4060-024	24	40	28	31.8	18
SK4060-025	25	40	30	33.8	20
SK4060-026	26	42	30	33.8	20
SK4060-027	27	42	30	35.8	20
SK4060-028	28	44	32	37.8	20
SK4060-029	29	44	32	37.8	20
SK4060-030	30	44	34	39.8	22
SK4060-032	32	44	36	41.8	22
SK4060-034	34	44	38	44	22

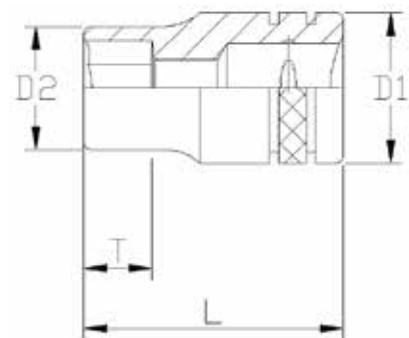

6pt

Cr-V

DIN 3124

HAND TOOLS

WORKSHOP EQUIPMENT

SPECIALIST VEHICLE TOOLS

SK4060-L-SERIE

1/2"

1/2" Deep sockets - 6Pt



	Size (mm)	L (mm)	D1 (mm)	D2 (mm)	T (mm)
SK4060-008L	8	77	21.8	13.2	12
SK4060-009L	9	77	21.8	13.9	12
SK4060-010L	10	77	21.8	15	12
SK4060-011L	11	77	21.8	16.3	12
SK4060-012L	12	77	21.8	17.6	12
SK4060-013L	13	77	21.8	18.8	12
SK4060-014L	14	77	21.8	20.4	15
SK4060-015L	15	77	21.8	21	15
SK4060-016L	16	77	23.3	22	15
SK4060-017L	17	77	22	23.8	15
SK4060-018L	18	77	23	25.8	18
SK4060-019L	19	77	23.5	25.8	18
SK4060-020L	20	77	24	27.8	18
SK4060-021L	21	77	25	27.8	18
SK4060-022L	22	77	26	29.8	21
SK4060-023L	23	77	27	31.8	24
SK4060-024L	24	77	28	31.8	24
SK4060-025L	25	77	30	33.8	24
SK4060-026L	26	77	30	33.8	24
SK4060-027L	27	77	30	35.8	27
SK4060-028L	28	77	32	37.8	27
SK4060-029L	29	77	32	37.8	27
SK4060-030L	30	77	34	39.8	30
SK4060-032L	32	77	36	41.8	32

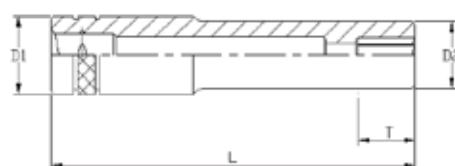

6pt

Cr-V

DIN
3124

SK4122-SERIE

1/2"

1/2" Sockets - 12Pt



	Size (mm)	L (mm)	D1 (mm)	D2 (mm)	T (mm)
SK4122-008	8	38	21.8	13.2	9
SK4122-009	9	38	21.8	13.9	10
SK4122-010	10	38	21.8	15	10
SK4122-011	11	38	21.8	16.3	10
SK4122-012	12	38	21.8	17.6	10
SK4122-013	13	38	21.8	18.8	10
SK4122-014	14	38	21.8	20.4	10
SK4122-015	15	38	21.8	21	14
SK4122-016	16	38	23.3	22	14
SK4122-017	17	38	22	23.8	14
SK4122-018	18	38	23	25.8	14
SK4122-019	19	38	23.5	25.8	18
SK4122-020	20	38	24	27.8	18
SK4122-021	21	38	25	27.8	18
SK4122-022	22	38	26	29.8	18
SK4122-023	23	40	27	31.8	18
SK4122-024	24	40	28	31.8	18
SK4122-026	26	42	30	33.8	20
SK4122-027	27	42	30	35.8	20
SK4122-030	30	44	34	39.8	22
SK4122-032	32	44	36	41.8	22
SK4122-034	34	44	38	44	22

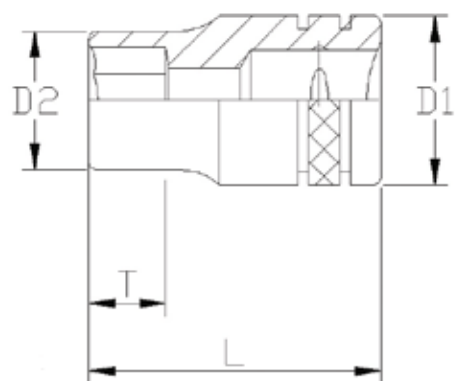

12pt

Cr-V

DIN
3124

SK4060-E-SERIE

1/2"

1/2" Sockets - TX-E

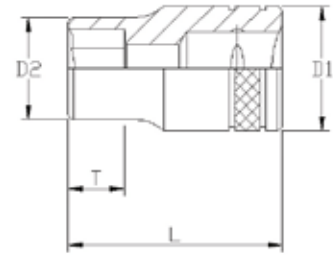

	Size	L (mm)	D1 (mm)	D2 (mm)
SK4060-010E	E10	38	21.8	13.2
SK4060-011E	E11	38	21.8	13.7
SK4060-012E	E12	38	21.8	15
SK4060-014E	E14	38	21.8	16.5
SK4060-016E	E16	38	21.8	18.7
SK4060-018E	E18	38	21.8	20.5
SK4060-020E	E20	38	22	23.8
SK4060-024E	E24	38	25	27.8



Cr-V

DIN 3120

SB40-T-SERIE

1/2"

1/2" Bit sockets - TX



	Size	L (mm)	D (mm)
SB40-T1055	T10	55	23.9
SB40-T1555	T15	55	23.9
SB40-T20100	T20	100	23.9
SB40-T2055	T20	55	23.9
SB40-T25100	T25	100	23.9
SB40-T2555	T25	55	23.9
SB40-T27100	T27	100	23.9
SB40-T2755	T27	55	23.9
SB40-T30100	T30	100	23.9
SB40-T3055	T30	55	23.9
SB40-T40100	T40	100	23.9
SB40-T40138	T40	138	23.9
SB40-T4055	T40	55	23.9
SB40-T45100	T45	100	23.9
SB40-T4555	T45	55	23.9
SB40-T50100	T50	100	23.9
SB40-T5055	T50	55	23.9
SB40-T55100	T55	100	23.9
SB40-T55138	T55	138	23.9
SB40-T5555	T55	55	23.9
SB40-T60100	T60	100	23.9
SB40-T6055	T60	55	23.9
SB40-T70100	T70	100	23.9
SB40-T7055	T70	55	23.9

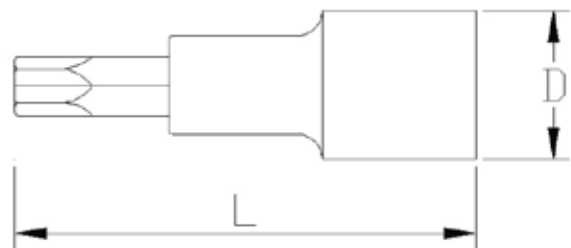

Cr-V

DIN 3120

POWER TOOLS

AIR TOOLS

TOOL STORAGE

HAND TOOLS

WORKSHOP EQUIPMENT

SPECIALIST VEHICLE TOOLS

SB40-TP-SERIE

1/2"

1/2" Bit sockets - Tamperproof TX



	Size	L (mm)	D (mm)
SB40-TP3055	T30	55	23.9
SB40-TP4055	T40	55	23.9
SB40-TP4555	T45	55	23.9
SB40-TP5055	T50	55	23.9
SB40-TP5555	T55	55	23.9
SB40-TP6055	T60	55	23.9



Cr-V

DIN
3120

SB40-M-SERIE

1/2"

1/2" Bit sockets - XZN



	Size	L (mm)	D (mm)
SB40-M06100	M6	100	23.9
SB40-M0655	M6	55	23.9
SB40-M08100	M8	100	23.9
SB40-M0855	M8	55	23.9
SB40-M10100	M10	100	23.9
SB40-M1055	M10	55	23.9
SB40-M12100	M12	100	23.9
SB40-M1255	M1	55	23.9
SB40-M14100	M14	100	23.9
SB40-M1455	M14	55	23.9



Cr-V

DIN
3120

SB40-H-SERIE

1/2"

1/2" Bit sockets - Hex



	Size (mm)	L (mm)	D (mm)
SB40-H0455	4	55	23.9
SB40-H05138	5	138	23.9
SB40-H0555	5	55	23.9
SB40-H06100	6	100	23.9
SB40-H0655	6	55	23.9
SB40-H07100	7	100	23.9
SB40-H0755	7	55	23.9
SB40-H08100	8	100	23.9
SB40-H0855	8	55	23.9
SB40-H0955	9	55	23.9
SB40-H10100	10	100	23.9
SB40-H1055	10	55	23.9
SB40-H1255	12	55	23.9
SB40-H1455	14	55	23.9
SB40-H1755	17	55	23.9
SB40-H1955	19	55	23.9



Cr-V

DIN
3120

SB40-SL-SERIE

1/2"

1/2" Bit sockets - Slotted



	Size (mm)	L (mm)	D (mm)
SB40-SL0855	8	55	15.2
SB40-SL1055	10	55	18.2
SB40-SL1255	12	55	20.2

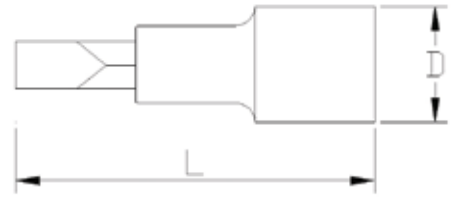

Cr-V
 DIN 3120



POWER TOOLS

AIR TOOLS

TOOL STORAGE

HAND TOOLS

WORKSHOP EQUIPMENT

SPECIALIST VEHICLE TOOLS

SK6061-SERIE

3/4"

3/4" Sockets - 6Pt



	Size (mm)	L (mm)	D1 (mm)	D2 (mm)	T (mm)
SK6061-019	19	50	33	29	13
SK6061-021	21	50	33	31	13
SK6061-022	22	50	36	32	14
SK6061-023	23	50	36	33	14
SK6061-024	24	50	36	34	16
SK6061-026	26	52	36	38	17
SK6061-027	27	52	36	38	18
SK6061-028	28	52	36	40	18
SK6061-029	29	52	38	40	18
SK6061-030	30	54	38	42	20
SK6061-032	32	56	38	44	22
SK6061-033	33	56	38	46	22
SK6061-034	34	56	38	46	22
SK6061-035	35	58	42	48	25
SK6061-036	36	58	42	50	25
SK6061-038	38	60	45	52	25
SK6061-041	41	64	45	56	28
SK6061-046	46	68	48	62	31
SK6061-050	50	72	48	68	34
SK6061-055	55	76	48	74	37
SK6061-060	60	78	48	80	38

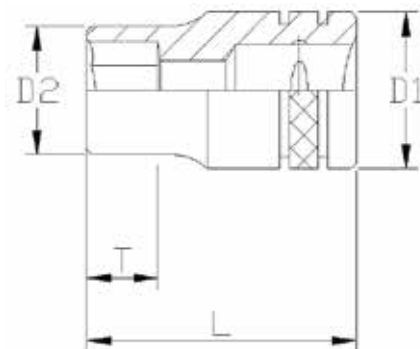

6pt

Cr-V

DIN
3124

SK6122-SERIE

3/4"

3/4" Sockets - 12Pt



	Size (mm)	L (mm)	D1 (mm)	D2 (mm)	T (mm)
SK6122-019	19	50	33	29	13
SK6122-022	22	50	36	32	14
SK6122-024	24	50	36	34	16
SK6122-027	27	52	36	38	18
SK6122-030	30	54	38	42	20
SK6122-032	32	56	38	44	22
SK6122-036	36	58	42	50	25
SK6122-038	38	60	45	52	25
SK6122-041	41	64	45	56	28
SK6122-046	46	68	48	62	31
SK6122-050	50	72	48	68	34
SK6122-055	55	76	48	74	37

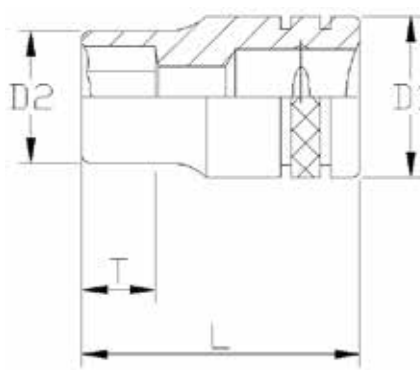

12pt

Cr-V

DIN
3124

ACCESSORIES

MET-SPARK-PLUG-SOCKET-SERIE

3/8" 1/2"

Spark plug sockets



Size

MET-1292	16 mm - 5/8"
MET-1293	21 mm - 13/16"

Size

MET-1395	16 mm - 5/8"
MET-1396	21 mm - 13/16"

SP3600-SERIE

3/8"

3/8" Spark plug sockets



Size (mm) L (mm) D (mm)

SP3120-014	(12Pt) 14		
SP3600-016	16	64	22
SP3600-018	18		
SP3600-021	21	64	27.8



SP-M-SERIE

3/8" 1/2"

Spark plug sockets magnetic



Size (mm) L (mm) D (mm)

SP3600-016M	16	64	22
SP3600-021M	21	64	27.8
SP4600-016M	16	64	22
SP4600-021M	21	64	27.8



SP4600-SERIE

1/2"

1/2" Spark plug sockets



Size (mm) L (mm) D (mm)

SP4600-016	16	64	22
SP4600-018	18		
SP4600-021	21	64	27.8



AD-SERIE

1/4"

1/4" Adapter 26 mm



Size (mm) L (mm)

AD20-038	1/4" x 3/8"	26
AD30-012	3/8" x 1/2"	36.2
AD30-014	3/8" x 1/4"	26.7
AD40-034	1/2" x 3/4"	50.5
AD40-038	1/2" x 3/8"	35.7
AD60-012	3/4" x 1/2"	57

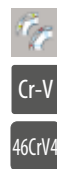

MET-ADAPTER-SERIE

1/4"

Adapters



Size (mm)

MET-1298	1/4" x 3/8"
MET-1494	1/4" x 3/8"

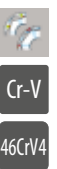

POWER TOOLS

AIR TOOLS

TOOL STORAGE

HAND TOOLS

WORKSHOP EQUIPMENT

SPECIALIST VEHICLE TOOLS

GWADS-SERIE

1/4" 3/8" 1/2"

Bit adapters



	Drive	Size (mm)
GWADS20	1/4"	10
GWADS30	3/8"	13
GWADS40	1/2"	19



HBSC-SERIE

1/4" 3/8" 1/2"

Bit couplers



	Size (mm)
HBSC2610	1/4"
HBSC3610S	5/16"
HBSC4610S	5/16"
MET-1498	1/4"



UJ-SERIE

1/4" 3/8" 1/2"

Universal joints



	Drive
UJ2300-001	1/4"
UJ3300-001	3/8"
UJ4300-001	1/2"

	Drive
UJ2300-001M	1/4"
UJ3300-001M	3/8"
UJ4300-001M	1/2"



MET-UNIVERSAL-JOINT-SERIE

1/4" 3/8" 1/2"

Universal joints



	Drive
MET-1296	1/2"
MET-1394	3/8"
MET-1492	1/4"



EX-SERIE

1/4" 3/8" 1/2"

Extension bars



	Drive	L (mm)
EX2040-050	1/4"	50
EX2040-075	1/4"	75
EX2040-100	1/4"	100
EX2040-150	1/4"	150
EX3040-050	3/8"	50
EX3040-075	3/8"	75
EX3040-150	3/8"	150
EX3040-250	3/8"	250
EX4040-050	1/2"	50
EX4040-075	1/2"	75
EX4040-125	1/2"	125
EX4040-150	1/2"	150
EX4040-250	1/2"	250
EX4040-600	1/2"	600



MET-EXTENSION-BAR-SERIE

1/4" 3/8" 1/2"

Extension bars



	Drive	L (mm)
MET-1287	1/2"	75
MET-1291	1/2"	250
MET-1297	1/2"	125
MET-1387	3/8"	125
MET-1391	3/8"	75
MET-1393	3/8"	150
MET-1488	1/4"	75
MET-1493	1/4"	50
MET-1496	1/4"	150



MET-EXTENSION-BAR-WOBBLE-SERIE 1/4" 3/8" 1/2"

Extension bars wobble



	Drive	L (mm)
MET-1288	1/2"	75
MET-1299	1/2"	125
MET-1388	3/8"	75
MET-1392	3/8"	150
MET-1397	3/8"	250
MET-1399	3/8"	40
MET-1499	1/4"	100



Wobble



MET-1294/1398/1497 1/4" 3/8" 1/2"

Two way adapter



	Drive
MET-1294	1/2"
MET-1398	3/8"
MET-1497	1/4"



STB-SERIE 1/4" 3/8" 1/2"

Sliding handles



	Drive	L (mm)
STB2100-115	1/4"	115
STB3100-165	3/8"	165
STB3100-200	3/8"	200
STB4100-250	1/2"	250
STB4100-300	1/2"	300
STB6100-450	3/4"	450



EX2040-050M 1/4" 3/8" 1/2"

1/4" Magnetic extension bar



	Drive	L (mm)
EX2040-050M	1/4"	50
EX3040-045M	3/8"	45
EX4040-050M	1/2"	50

	Drive	L (mm)
EX3040-075M	3/8"	75
EX4040-075M	1/2"	75



MET-1495 1/4"

1/4" Spinner handle



SH2400-150 1/4"

1/4" Spinner handle



POWER TOOLS

AIR TOOLS

TOOL STORAGE

HAND TOOLS

WORKSHOP EQUIPMENT

SPECIALIST VEHICLE TOOLS

SW4410-SERIE

1/2"

Breaker bars



	L (mm)	Repair kit
SW4410-380	380	MET-1295SN
SW4410-460	460	MET-1295SN
MET-1295	410	MET-1295SN

Cr-V
DIN 3122

SW4712-600

1/2"

1/2" Breaker bar with ratchet function



L	600 mm
Teeth	24

24
Cr-V
DIN 3122

MET-1491

1/4"

1/4" Fingertight ratchet 40 teeth



Teeth	40
-------	----

40
46CrV4

MET-REVERSIBLE-RATCHET-SERIE

1/4" 3/8" 1/2"

Reversible ratchets



	Drive	Teeth	Repair kit
MET-1290	1/2"	40	MET-1290SN
MET-1390	3/8"	38	MET-1390SN
MET-1490	1/4"	40	MET-1490SN

38
40
46CrV4

B-1402

1/4" 3/8" 1/2"

1/4" Pear-head closed ratchet



	Drive	L (mm)	Teeth	Repair kit
B-1202	1/2"	250	72	B-1202-R
B-1402	1/4"	128	72	B-1402-R
B-3802	3/8"	198	72	B-3802-R

72
Cr-V
DIN 3122

B-1403

1/4" 3/8" 1/2"

1/4" Reversible swivel-head ratchet with quick release



	Drive	L (mm)	Teeth	Repair kit
B-1203	1/2"	285	72	B-1203-R
B-1403	1/4"	153	72	B-1403-R
B-3803	3/8"	230	72	B-3803-R

72
Cr-V
DIN 3122

RS14-SERIE

1/4" 3/8" 1/2"

Feinzahn-Umschaltknarre 72 Zähne



	Drive	Teeth	Repair kit
RS1420-272	1/4"	72	RSR272-R
RS1430-272	3/8"	72	RSR372-R
RS1440-272	1/2"	72	RSR472-R



Cr-V

DIN 3122

RS4310-036

1/2"

1/2" Extractable ratchet



Teeth	36
L (mm)	305 ~ 445



Cr-V

RS6211-072

3/4"

3/4" Reversible ratchet with quick release 510 mm



L	510 mm
Teeth	72



Cr-V

DIN 3122

RS6211-124

3/4"

3/4" Reversible ratchet with quick release



	Drive	L (mm)	Teeth
RS6211-124	3/4"	505	24
RS8211-124	1"	813	24



Cr-V

DIN 3122

RS61D2-148

3/4"

3/4" 48T Reversible extendable ratchet 450 - 750 mm



RS6211-124RK

3/4"

3/4" repairkit



POWER TOOLS

AIR TOOLS

TOOL STORAGE

HAND TOOLS

WORKSHOP EQUIPMENT

SPECIALIST VEHICLE TOOLS

TWM2-SERIE

1/4" 3/8" 1/2" 1"

Calibrated ratcheting torque wrenches

Large scale window with unit.
Unit (Nm) with vernier.
At all times only one unit in the viewing area,
avoids reading errors.



Window for fine adjustments
of 1 Nm, allows very accurate settings.



Automatic actuation: The BOXO-Torque Wrench - TWM2 actuates with a clear tactile impulse and audible signal and is immediately ready for operation again.

Robust steel tube: With high corrosion protection, chromeplated, satin chrome plated.



Ergonomic anti slip soft grip handle

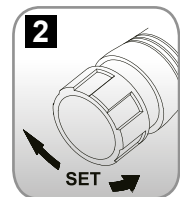

Classified to DIN EN ISO 6789:2003 Type II Class A, with a factory certificate allowing for operations to be traced back. Calibrated to a +/- 3 % tolerance of the adjusted value.

Serial number on the wrench and on the certificate for product identification & traceability



	Nm	Drive	L (mm)	Teeth	Repair set
TWM2-60N	12 ~ 60 Nm	3/8"	395	24	TWR-M3
TWM2-100N	20 ~ 100 Nm	3/8"	423	24	TWR-M3
TWM2-200N	40 ~ 200 Nm	1/2"	556	24	TWR-M4
TWM2-320N	60 ~ 320 Nm	1/2"	586	24	TWR-M4
TWM2-800N	150 ~ 800 Nm	3/4"	1166	36	TWR-M6
TWM2-1000N	200 ~ 1000 Nm	1"	1390	36	TWR-M8
TWM2-1500N	300 ~ 1500 Nm	1"	1758	36	TWR-M8



With 3/8" & 1/2" square drive and integrated reversible ratchet function for controlled clockwise tightening.

For the BOXO Torque Wrench TWM2: Switch the lever of the reversible ratchet to correspond with the desired direction, clockwise or counter-clockwise.

Concealed setting drill hole, for secured adjusting/ setting system.

Cr-V

DIN 6789

WRENCHES

MET-11-SERIE

Combination wrenches - Metric and Inch



	Size (mm)
MET-1108	8 mm - 5/16"
MET-1109	9 mm - 11/32"
MET-1110	10 mm - 3/8"
MET-1111	11 mm - 7/16"
MET-1112	12 mm - 15/32"
MET-1113	13 mm - 1/2"
MET-1114	14 mm - 9/16"
MET-1115	15 mm - 19/32"
MET-1116	16 mm - 5/8"
MET-1117	17 mm - 11/16"
MET-1118	18 mm - 23/32"
MET-1119	19 mm - 3/4"
MET-1120	20/21 mm - 13/16"
MET-1122	22/23 mm - 7/8"
MET-1124	24 mm - 15/16"
MET-1126	26/27 mm - 1 1/16"
MET-1129	29/30 mm - 1 3/16"
MET-1132	31/32 mm - 1 1/4"



MET-0106

Combination wrench set 6pc



- 10 mm - 3/8"
- 11 mm - 7/16"
- 13 mm - 1/2"
- 14 mm - 9/16"
- 16 mm - 5/8"
- 17 mm - 11/16"



MET-0107

Combination wrench set 7pc



- 10 mm - 3/8"
- 11 mm - 7/16"
- 13 mm - 1/2"
- 14 mm - 9/16"
- 16 mm - 5/8"
- 17 mm - 11/16"
- 19 mm - 3/4"



MET-0110

Combination wrench set in pouch 10pc



- 10 mm - 3/8"
- 11 mm - 7/16"
- 13 mm - 1/2"
- 14 mm - 9/16"
- 15 mm - 19/32"
- 16 mm - 5/8"
- 17 mm - 11/16"
- 18 mm - 23/32"
- 19 mm - 3/4"



MET-0125

Combination wrench set in pouch 14pc



- 8 mm - 5/16"
- 9 mm - 11/32"
- 10 mm - 3/8"
- 11 mm - 7/16"
- 12 mm / 15/32"
- 13 mm - 1/2"
- 14 mm - 9/16"
- 15 mm - 19/32"
- 16 mm - 5/8"
- 17 mm - 11/16"
- 18 mm - 23/32"
- 19 mm - 3/4"
- 20/21 mm - 13/16"
- 22/23 mm - 7/8"



MET-0135

Combination wrench set in pouch 15pc



- 8 mm - 5/16"
- 9 mm - 11/32"
- 10 mm - 3/8"
- 11 mm - 7/16"
- 12 mm / 15/32"
- 13 mm - 1/2"
- 14 mm - 9/16"
- 15 mm - 19/32"
- 16 mm - 5/8"
- 17 mm - 11/16"
- 18 mm - 23/32"
- 19 mm - 3/4"
- 20/21 mm - 13/16"
- 22/23 mm - 7/8"
- 24 mm - 15/16"
- 26/27 mm - 1 1/16"
- 29/30 mm - 1 3/16"
- 31/32 mm - 1 1/4"



POWER TOOLS

AIR TOOLS

TOOL STORAGE

HAND TOOLS

WORKSHOP EQUIPMENT

SPECIALIST VEHICLE TOOLS

WR1710-SERIE

Combination wrenches 15°



	Size (mm)	L (mm)	D1 (mm)	D2 (mm)	T1 (mm)	T2 (mm)
WR1710-006	6	105	15.5	10.1	4.2	4.7
WR1710-007	7	115	17	11.5	4.4	5
WR1710-008	8	125	19.2	12.8	4.6	5.5
WR1710-009	9	135	21.2	14.2	4.8	5.9
WR1710-010	10	145	23.2	15.6	5.0	6.5
WR1710-011	11	155	25.3	16.9	5.4	6.9
WR1710-012	12	165	27.2	18.3	5.5	7.3
WR1710-013	13	175	29.4	19.7	5.9	7.8
WR1710-014	14	185	31.5	21.2	6.2	8.3
WR1710-015	15	195	33.2	22.5	6.4	8.6
WR1710-016	16	205	34.7	24	6.7	8.9
WR1710-017	17	215	36.5	25.3	6.9	9.3
WR1710-018	18	225	38.7	26.8	7.2	9.9
WR1710-019	19	235	40.7	28.1	7.4	10.5
WR1710-020	20	245	43.1	29.7	7.7	10.9
WR1710-021	21	255	44.8	31.3	8	11.3
WR1710-022	22	265	46.9	32.6	8.2	11.5
WR1710-023	23	275	48.3	34.2	8.4	11.8
WR1710-024	24	285	50.4	35.5	8.7	12.1
WR1710-025	25	295	52	36.9	8.9	12.5
WR1710-026	26	305	53.6	38.2	9.2	12.8
WR1710-027	27	315	55.7	39.6	9.4	13.1
WR1710-028	28	325	57.6	40.9	9.7	13.3
WR1710-029	29	335	59.7	42.3	9.9	13.5
WR1710-030	30	345	61.8	43.7	10.1	13.7
WR1710-032	32	365	65.8	46.4	10.4	14.3
WR1710-034	34	380	69.2	48.8	10.7	15
WR1710-036	36	410	74	53	13.5	19.4
WR1710-041	41	460	84	61	16	21.6
WR1710-046	46	500	92	66	17	23
WR1710-050	50	540	73	73	18	24.6

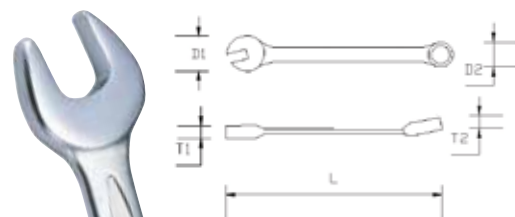

12pt
Cr-V
DIN 3113

WR1710-12B

Combination wrench set in pouch 12pc



Contents:

8, 9, 10, 11, 12, 13, 14, 15, 16, 17, 18, 19 mm



12pt
Cr-V
DIN 3113

WR1710-16B

Combination wrench set in pouch 16pc



Contents:

6, 7, 8, 9, 10, 11, 12, 13, 14, 15, 16, 17, 18, 19, 22, 24 mm



12pt
Cr-V
DIN 3113

B-0018

Combination spanner set 15° 18pc



Contents:

6, 7, 8, 9, 10, 11, 12, 13, 14, 15, 16, 17, 18, 19, 20, 21, 22, 24 mm

■ 15° offset jaw



12pt
Cr-V
DIN 3113

WR1710-03B

Combination wrench set in pouch 3pc



Contents:

27, 30, 32 mm



12pt
Cr-V
DIN 3113

B-S10-SERIE

Stubby combination wrenches



	Size (mm)
B-S1008	8
B-S1009	9
B-S1010	10
B-S1011	11
B-S1012	12
B-S1013	13
B-S1014	14
B-S1015	15
B-S1016	16
B-S1017	17
B-S1018	18
B-S1019	19



U-WR1710-I10BB

Mini combination ignition wrench set 10pc



For easy access in difficult to reach areas

Contents:

- 4 mm
- 4.5 mm
- 5 mm
- 5.5 mm
- 6 mm
- 7 mm
- 8 mm
- 9 mm
- 10 mm
- 11 mm

B-S0008

Stubby combination wrench set 8pc



- 12pt flank profile
- 15° offset jaw
- DIN 3113/ANSI standard

Contents:

- 8, 10, 12, 13, 14, 15, 17, 19 mm



POWER TOOLS

AIR TOOLS

TOOL STORAGE

HAND TOOLS

WORKSHOP EQUIPMENT

SPECIALIST VEHICLE TOOLS

WR1720-SERIE

Open end wrenches 15°



	Size (mm)	L (mm)	D1 (mm)	D2 (mm)	T2 (mm)
WR1720-0607	6x7	123	18	15.5	3.2
WR1720-0809	8x9	140	22.7	20.4	3.4
WR1720-1011	10x11	156	27.1	24.9	3.8
WR1720-1213	12x13	172	31.3	29.2	3.9
WR1720-1415	14x15	190	35.3	33.3	4.2
WR1720-1617	16x17	204	38.9	37.1	4.6
WR1720-1819	18x19	221	42.8	40.9	4.8
WR1720-2022	20x22	237	48.8	44.8	5.2
WR1720-2123	21x23	247	50.8	46.8	5.4
WR1720-2427	24x27	263	59.1	52.8	5.8
WR1720-2528	25x28	279	61.3	54.8	6
WR1720-3032	30x32	298	69.8	65.4	6.6
WR1720-3436	34x36	350	76	69.8	7.5
WR1720-3641	36x41	380	87	76	9
WR1720-4650	46x50	465	104	95	11

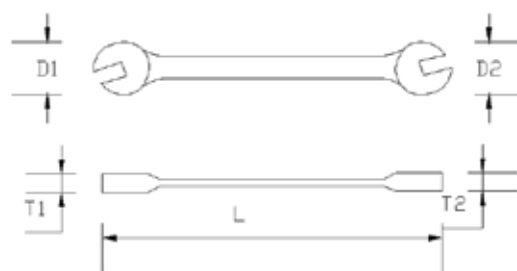

Cr-V

DIN 3113

WR1720-06B

Open end wrench set in pouch 6pc

Contents:

8x9, 10x11, 12x13, 14x15, 16x17, 18x19 mm



Cr-V DIN 3110

WR1720-08B

Open end wrench set in pouch 8pc

Contents:

6x7, 8x9, 10x11, 12x13, 14x15, 16x17, 18x19, 20x22 mm



Cr-V DIN 3110

WR1720-12B

Open end wrench set in pouch 12pc

Contents:

6x7, 8x9, 10x11, 12x13, 14x15, 16x17, 18x19, 21x23, 22x24, 24x26, 25x28, 30x32 mm



Cr-V DIN 3110

WR1730-SERIE

Double ring wrenches offset 75°



	Size (mm)	L (mm)	D1 (mm)	D2 (mm)	T2 (mm)
WR1730-0607	6x7	168	12.2	10.7	6
WR1730-0809	8x9	183	15.1	13.6	7
WR1730-1011	10x11	198	18	16.6	8
WR1730-1213	12x13	217	20.9	19.5	9
WR1730-1415	14x15	239	23.7	22.4	10
WR1730-1617	16x17	260	26.7	25.3	11
WR1730-1819	18x19	292	29.7	28.2	11.6
WR1730-2022	20x22	318	34	31.1	12.2
WR1730-2123	21x23	330	36.9	34	12.5
WR1730-2427	24x27	345	41.4	36.9	13.5
WR1730-2528	25x28	355	43.8	40.4	13.8
WR1730-3032	30x32	370	48.5	45.5	15.4

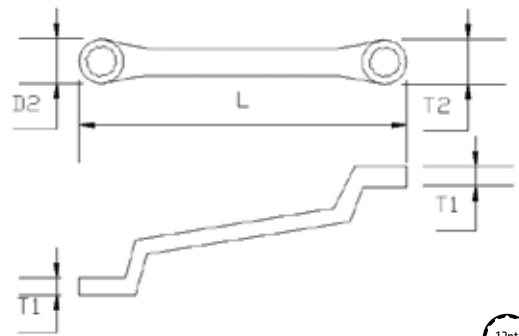

WR1730-06B

B-0008

B-0008-XL

Double ring wrench set, offset 75° in pouch 6pc

Contents:
6x7, 8x9, 10x11, 12x13, 14x15, 16x17 mm

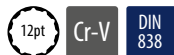

Double ring wrench offset 75° set 8pc

Contents:
6x7, 8x9, 10x11, 12x13, 14x15, 16x17, 18x19, 20x22 mm



Combination wrench set XL in pouch 8pc

Contents:
21, 22, 24, 27, 30, 32, 34, 36 mm



POWER TOOLS

AIR TOOLS

TOOL STORAGE

HAND TOOLS

WORKSHOP EQUIPMENT

SPECIALIST VEHICLE TOOLS

B-HM-SERIE

Half-Moon wrenches



	Size (mm)
B-HM0810	8x10
B-HM1113	11x13
B-HM1214	12x14
B-HM1315	13x15
B-HM1719	17x19
B-HM1922	19x22



Cr-V

DIN 3113

B-HM0005

Half-Moon wrench set 5pc



Contents:
8 x10, 11x13, 12x14, 13x15,
7x19 mm



Cr-V

DIN 3113

WR1740S-SERIE

TX-E Ring wrenches

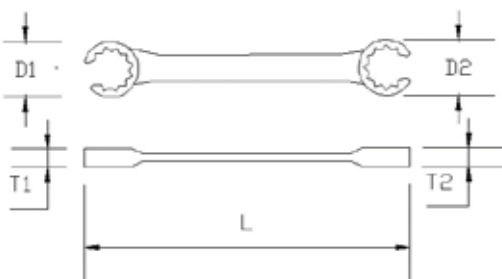

WR1740S-06B

TX-E-Ring wrench set 6pc



Contents:
E6xE8, E7xE11, E10xE12,
E14xE18, E16xE22, E20xE24



Cr-V

DIN 3113



Cr-V

DIN 3113

	Size	L (mm)	D1 (mm)	D2 (mm)	T1 (mm)	T2 (mm)
WR1740S-0608	E6xE8	114	7.3	9.7	4.2	5.3
WR1740S-0711	E7xE11	130	10.8	14.8	5.2	7.2
WR1740S-1012	E10xE12	141	12.3	15.1	6.5	7.7
WR1740S-1418	E14xE18	180	17	21.1	8.2	10.3
WR1740S-1622	E16xE22	205	19.7	27.3	8.4	11.8
WR1740S-2024	E20xE24	224	23.9	27.9	11	12.6

GWSO-SERIE

TX-E Double ring ratcheting wrenches

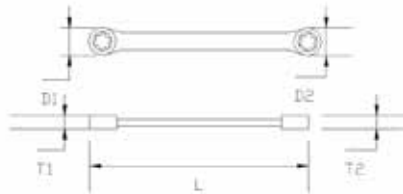

	Size	L (mm)	D1 (mm)	D2 (mm)	T1 (mm)	T2 (mm)
GWSO-0608	E6xE8	130.4	17.4	20.9	7.4	7.4
GWSO-1012	E10xE12	144.4	20.9	22.9	7.4	8.7
GWSO-1418	E14xE18	181.4	27.4	30.4	8.7	10.3
GWSO-2024	E20xE24	224.4	31.9	34.4	10.3	10.3



Cr-V

DIN 3113

WR1740-06B

Flare nut wrench set in pouch 6pc



Contents:

6Pt: - 8x9, 10x11, 13x14 mm
12Pt - 15x17, 16x18, 19x21 mm



6pt

12pt

Cr-V

DIN 3118

WR1740-SERIE

Flare nut wrenches

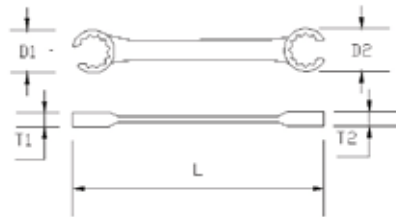

6pt

12pt

Cr-V

DIN 3118

	Size	L (mm)	D1 (mm)	D2 (mm)	T1 (mm)	T2 (mm)
WR1740-0809	8x9 (6Pt)	145	20.8	18.4	8.5	7
WR1740-0911	9x11 (6Pt)	152	22.5	20.5	8.8	8.2
WR1740-1011	10x11 (6Pt)	152	22.6	20.8	9	8.5
WR1740-1012	10x12 (6Pt)	152	22.6	20.8	9	8.5
WR1740-1213	12x13 (6Pt)	165	25	22.6	10.5	9
WR1740-1314	13x14 (6Pt)	175	27.7	25.2	11.2	9.9
WR1740-1415	14 (6Pt)x15 (12Pt)	196	30	27.5	12.2	11
WR1740-1517	15x17 (12Pt)	196	30.2	27.8	11.8	10.9
WR1740-1618	16x18 (12Pt)	196	30.2	27.6	11.8	10.9
WR1740-1719	17x19 (12Pt)	210	32.5	30.2	14	12
WR1740-1921	19x21 (12Pt)	231	37.5	32.8	15.8	13.5
WR1740-2224	22x24 (12Pt)	252	41	38.0	17	16



POWER TOOLS

AIR TOOLS

TOOL STORAGE

HAND TOOLS

WORKSHOP EQUIPMENT

SPECIALIST VEHICLE TOOLS

WR1770-SERIE

Flexible flare nut wrenches



	Size (mm)
WR1770-10	10
WR1770-11	11
WR1770-12	12
WR1770-8	8
WR1770-9	9



WR1770-05B

Flexible flare nut wrench set in pouch 5pc



Contents:
8, 9, 10, 11, 12 mm



WR1780-06B

Double flexible flare nut wrench set in pouch 6pc



Contents:
8x10, 9x11, 12x14, 13x15, 16x18, 17x19 mm



WR1780-SERIE

Double flexible flare nut wrenches



	Size (mm)
WR1780-0810	8x10
WR1780-0911	9x11
WR1780-1214	12x14
WR1780-1315	13x15
WR1780-1618	16x18
WR1780-1719	17x19



GWFO-SERIE

Flex-head ratcheting wrenches



	Size (mm)	L (mm)	D1 (mm)	D2 (mm)	T1 (mm)	T2 (mm)
GWFO-008	8	136	17.4	16.95	7.4	4.9
GWFO-009	9	158	20.9	20.8	7.4	5.8
GWFO-010	10	158	20.9	20.8	7.4	5.8
GWFO-011	11	175	23.4	25.1	8.7	6.2
GWFO-012	12	175	23.4	25.1	8.7	6.2
GWFO-013	13	185	24.9	27.15	8.7	6.4
GWFO-014	14	193	27.4	29.3	8.7	7.0
GWFO-015	15	213	30.4	33.0	10.3	7.4
GWFO-016	16	213	30.4	33.0	10.3	7.4
GWFO-017	17	231	31.9	35.2	10.3	8.2
GWFO-018	18	249	34.5	39.4	10.5	9.0
GWFO-019	19	249	34.5	39.4	10.5	9.0

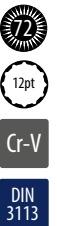
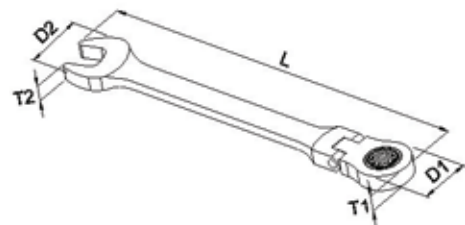

GWFO-12B

Flex-head ratcheting wrench set in pouch 12pc



Contents:
8, 9, 10, 11, 12, 13, 14, 15, 16, 17, 18, 19 mm



WR1790-12B

Open end ratcheting wrench set 12pc



Contents:
8, 9, 10, 11, 12, 13, 14, 15, 16, 17, 18, 19 mm



POWER TOOLS

AIR TOOLS

TOOL STORAGE

HAND TOOLS

WORKSHOP EQUIPMENT

SPECIALIST VEHICLE TOOLS

SIN-171-SERIE

XXL ring spanners

Extra-long spanners to benefit in tight spaces such as an engine room

- Thin walled
- Flank profile
- 40% longer



40% LONGER



Size (mm)

SIN-171.1011	10x11
SIN-171.1214	12x14
SIN-171.1315	13x15
SIN-171.1618	16x18
SIN-171.1719	17x19
SIN-171.2021	20x21
SIN-171.2224	22x24



Cr-V

DIN 3113

U-SIN-170.0006

XL Ring spanner set 6pc

Extra-long spanners to benefit in tight spaces such as an engine room.

- Thin walled
- Flank profile



40% LONGER



Cr-V

DIN 3113

Contents:
10x11, 12x14, 13x15,
16x18, 17x19, 22x24 mm

B-XLFH-SERIE

XL Flex-head ratcheting spanners

- 180° operational swing
- 72 teeth
- 40% longer



40% LONGER



Size (mm)

B-XLFH0809	8x9
B-XLFH1011	10x11
B-XLFH1213	12x13
B-XLFH1415	14x15
B-XLFH1618	16x18
B-XLFH1719	17x19



Cr-V

DIN 3113

B-XLF0006

XL Flex-head ratcheting spanner set 6pc

- 180° operational swing
- 72 teeth
- 40% longer



40% LONGER



Cr-V

DIN 3113

Contents:
8x9, 10x11, 12x13, 14x15,
16x18, 17x19 mm

GWNRO-SERIE

Ratcheting wrenches



	Size (mm)	L (mm)	D1 (mm)	D2 (mm)	T1 (mm)	T2 (mm)
GWNRO-008	8	134	17.1	16.7	7.4	4.7
GWNRO-009	9	158	21	21	7.4	5.5
GWNRO-010	10	158	21	21	7.4	5.5
GWNRO-011	11	164	22.6	23	8.7	6
GWNRO-012	12	167	23.8	25	8.7	6.2
GWNRO-013	13	177	24.9	27.5	8.7	6
GWNRO-014	14	189	27	29	8.7	7
GWNRO-015	15	198	28.1	31.5	10.3	7.2
GWNRO-016	16	204	29.9	33	10.3	7.5
GWNRO-017	17	224	31.9	34.9	10.3	8
GWNRO-018	18	245	34.4	38.9	10.3	8.8
GWNRO-019	19	245	34.4	38.9	10.3	8.8

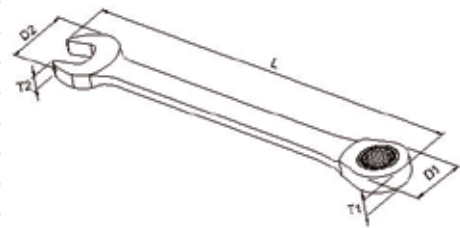

- 72
- 12pt
- Cr-V
- DIN 3113

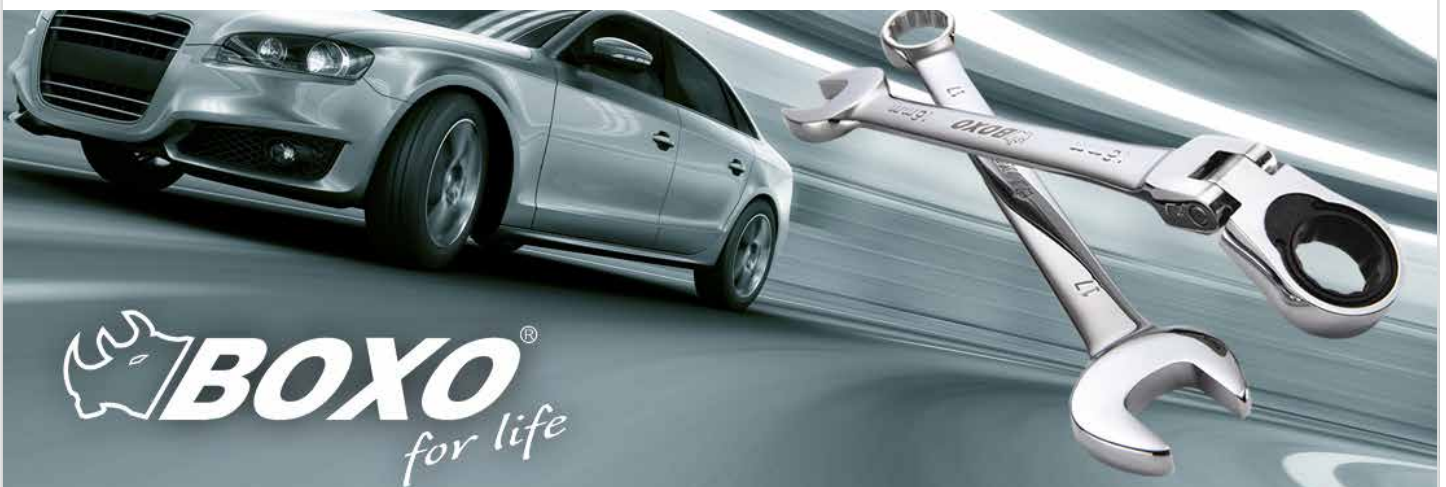

GWNRO-4CB

Non-reversible ratcheting wrench set 4pc



Contents:
10, 13, 17, 19 mm



- 72
- 12pt
- Cr-V
- DIN 3113

GWNRO-12B

Non-reversible ratcheting wrench set in pouch 12pc



Contents:
8, 9, 10, 11, 12, 13, 14, 15, 16, 17, 18, 19 mm



- 72
- 12pt
- Cr-V
- DIN 3113

GWRO-SERIE

Reversible ratcheting wrenches

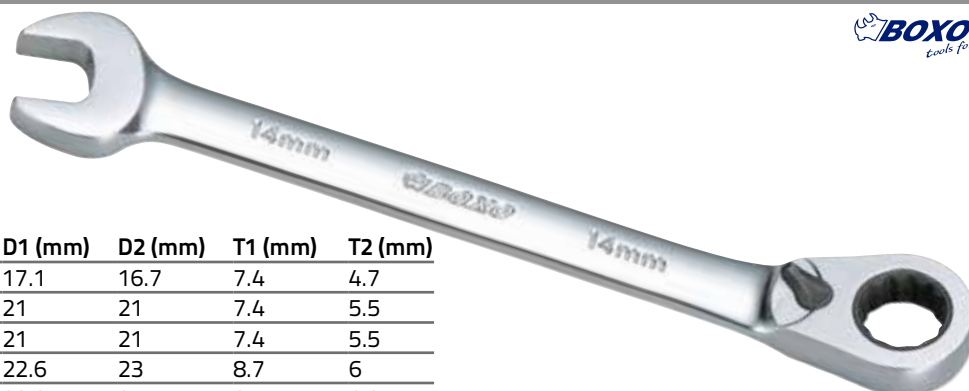

	Size (mm)	L (mm)	D1 (mm)	D2 (mm)	T1 (mm)	T2 (mm)
GWRO-008	8	134	17.1	16.7	7.4	4.7
GWRO-009	9	158	21	21	7.4	5.5
GWRO-010	10	158	21	21	7.4	5.5
GWRO-011	11	164	22.6	23	8.7	6
GWRO-012	12	167	23.8	25	8.7	6.2
GWRO-013	13	177	24.9	27.5	8.7	6
GWRO-014	14	189	27	29	8.7	7
GWRO-015	15	198	28.1	31.5	10.3	7.2
GWRO-016	16	204	29.9	33	10.3	7.5
GWRO-017	17	224	31.9	34.9	10.3	8
GWRO-018	18	245	34.4	38.9	10.6	8.8
GWRO-019	19	245	34.4	38.9	10.6	8.8

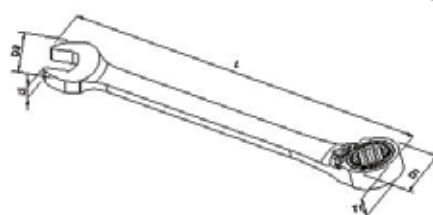

12pt

Cr-V

B-SR0010

Reversible ratcheting wrench stubby 10-19 mm 10pc

Contents:

10, 11, 12, 13, 14, 15, 16, 17, 18, 19 mm



GWRO-4CB

Reversible ratcheting wrench set 4pc

Contents:

10, 13, 17, 19 mm



12pt

Cr-V

GWRO-12B

Reversible ratcheting wrench set in pouch 12pc

Contents:

8, 9, 10, 11, 12, 13, 14, 15, 16, 17, 18, 19 mm



12pt

Cr-V

WR1911-SERIE

Double ended flex socket wrenches 12Pt



	Size (mm)	L (mm)	D1 (mm)	D2 (mm)
WR1911-0607	6x7	176	10.9	10.9
WR1911-0809	8x9	180	13.8	13.8
WR1911-1011	10x11	200	14.7	15.9
WR1911-1213	12x13	220	17.9	18.7
WR1911-1415	14x15	242	19.6	21.8
WR1911-1617	16x17	244	19.6	21.8
WR1911-1819	18x19	275	25.8	25.8



WR1911-06B

Double ended flex socket wrench set in pouch 6pc



Contents:
8x9, 10x11, 12x13, 14x15, 16x17, 18x19 mm



WR1921-SERIE

Double ended flex hex wrenches



	Size (mm)
WR1921-0225	H2xH2.5
WR1921-0304	H3xH4
WR1921-0506	H5xH6
WR1921-0810	H8xH10
WR1921-1214	H12xH14



WR1921-05B

Double ended flex hex wrench set in pouch 5pc



Contents:
H2xH2.5, H3xH4, H5xH6, H8xH10, H12xH14



POWER TOOLS

AIR TOOLS

TOOL STORAGE

HAND TOOLS

WORKSHOP EQUIPMENT

SPECIALIST VEHICLE TOOLS

WR1931-SERIE

Double ended flex TX-wrenches



Size

WR1931-1520	T15xT20
WR1931-2527	T25xT27
WR1931-3040	T30xT40
WR1931-4550	T45xT50
WR1931-5560	T55xT60



WR1931-05B

Double ended flex TX-wrench set in pouch 5pc



Contents: T15xT20, T25xT27, T30xT40, T45xT50, T55xT60



WR1941-SERIE

Double ended flex TX-E wrenches



Size

WR1941-0608	E6xE8
WR1941-1011	E10xE11
WR1941-1012	E10xE12
WR1941-1416	E14xE16
WR1941-1820	E18xE20
WR1941-2224	E22xE24



WR1941-06B

Double ended flex TX-E wrenches set in pouch 6pc



Contents: E6xE8, E10xE11, E10xE12, E14xE16, E18xE20, E22xE24



WR1513-SERIE

Adjustable wrenches with composite grip

- Non-slip handle
- Wide jaw openings

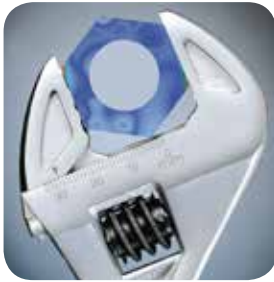

	Length	Size (mm)
WR1513-004	100	0 ~ 17
WR1513-006	150	0 ~ 24
WR1513-008	200	0 ~ 28
WR1513-010	250	0 ~ 33
WR1513-012	300	0 ~ 38
WR1513-015	375	0 ~ 51

Cr-V

DIN
3117 -
1988

WR1523-SERIE

Adjustable wrenches industrial black

- Wide jaw openings



	Length	Size (mm)
WR1523-018	450	0 ~ 60
WR1523-024	600	0 ~ 70

B-AW0003

Adjustable wrench set 3pc

- Non-slip handle
- Wide jaw openings

Contents:

- 200 mm
- 250 mm
- 300 mm



Cr-V

DIN
3117 -
1988



POWER TOOLS

AIR TOOLS

TOOL STORAGE

HAND TOOLS

WORKSHOP EQUIPMENT

SPECIALIST VEHICLE TOOLS

SCW-006PB

Precision screwdriver set 6pc



Contents:

- PH00x50, PH0x50, PH1x50, SL1.5x50, SL2x50, SL3x50



SCWA-7CB

Screwdriver set in display 7pc

Contents:

- SCW-1611-04100: SL4x100 mm
- SCW-1611-06100: SL6x100 mm
- SCW-1611-08150: SL8x150 mm
- SCW-1611-95150: SL9.5x150 mm
- SCW-1621-01100: PH1x100 mm
- SCW-1621-02100: PH2x100 mm
- SCW-1621-03150: PH3x150 mm



B-8015

Screwdriver set 15pc



- Ergonomic comfort-grip handles with non-slip finish
- Resistant to damage from most oils and solvents
- Shaft made from chrome plated SVCM steel
- Hardened tip
- Some drivers with a hex bolt

Contents:

- SL3x75, SL4x100, SL5.5x75, SL6x100, SL8x150, SL10x200 mm
- PH0x75, PH1x75, PH2x100, PH2x150, PH3x150 mm
- PZ0x75, PH1x100, PH2x100, PH3x150 mm



SCWAT-7CB

TX-screwdriver set 7pc

Contents:

- SCW-1631-10075: T10x75
- SCW-1631-15075: T15x75
- SCW-1631-20075: T20x75
- SCW-1631-25100: T25x100
- SCW-1631-27100: T27x100
- SCW-1631-30100: T30x100
- SCW-1631-40125: T40x125



SCW6100-SERIE

Precision screwdrivers Phillips



	Size
SCW6100-0050	PH00x50
SCW6100-0150	PH0x50
SCW6100-050	PH1x50

SCW6200-SERIE

Precision screwdrivers Slotted



	Size
SCW6200-1550	SL1.5x50
SCW6200-2050	SL2.0x50
SCW6200-3050	SL3.0x50



SCW1621-SERIE

Phillips screwdrivers standard



	Size	L (mm)	L1 (mm)	D1 (mm)
SCW1621-00075	PH0	145	75	3
SCW1621-01100	PH1	194	100	5
SCW1621-02038	PH2	100	38	6
SCW1621-02100	PH2	210	100	6
SCW1621-03150	PH3	270	150	8



SCW1611-SERIE

Screwdrivers Slotted



	Size (mm)	L (mm)	L1 (mm)	D (mm)
SCW1611-03075	3	145	75	3
SCW1611-04100	4	194	100	4
SCW1611-06038	6	100	38	6
SCW1611-06100	6	210	100	6
SCW1611-08150	8	270	150	8
SCW1611-95200	9.5	320	200	9.5



POWER TOOLS

AIR TOOLS

TOOL STORAGE

HAND TOOLS

WORKSHOP EQUIPMENT

SPECIALIST VEHICLE TOOLS

SCW1641-SERIE

Pozi screwdrivers standard



	Size	L (mm)	L1 (mm)	D (mm)
SCW1641-00075	PZ0	145	75	3
SCW1641-01100	PZ1	194	75	5
SCW1641-02100	PZ2	210	100	6
SCW1641-03150	PZ3	270	150	8



SCW1631-SERIE

TX Screwdrivers



	Size	L (mm)	L1 (mm)	D (mm)
SCW1631-08075	T8	169	75	3
SCW1631-10075	T10	169	75	4
SCW1631-15075	T15	169	75	4
SCW1631-20075	T20	169	75	4
SCW1631-25100	T25	210	100	4
SCW1631-27100	T27	210	100	6
SCW1631-30100	T30	210	100	6
SCW1631-40125	T40	245	125	8
SCW1631-45150	T45	270	150	-
SCW1631-50175	T50	295	175	-



SCW1620-SERIE

Phillips screwdrivers go-through



	Size	L (mm)	L1 (mm)	D (mm)
SCW1620-01100	PH1	194	100	5
SCW1620-02100	PH2	210	100	6
SCW1620-03150	PH3	270	150	8



SCW1610-SERIE

Screwdrivers go-through slotted



	Size (mm)	L (mm)	L1 (mm)	D (mm)
SCW1610-05100	5	194	100	5
SCW1610-06100	6	210	100	6
SCW1610-08150	8	270	150	8
SCW1610-95200	9.5	320	200	9.5



BD2710-500

1/4"

1/4" flexible quick release bit driver



LED-002 Magnetic, mirror and led lamp set

HBSHM

1/4"

1/4" Bit screwdriver



Cr-V

BH4282-060

1/4"

1/4" Stainless steel magnetic bitholder



POWER TOOLS

AIR TOOLS

TOOL STORAGE

HAND TOOLS

WORKSHOP EQUIPMENT

SPECIALIST VEHICLE TOOLS

B-HH0007

Quick-select hex key wrench set 7pc



Contents:

1.5, 2, 2.5, 3, 4, 5, 6 mm



Cr-V

B-TH0008

Quick-select TX key wrench set 8pc



Contents:

T5, T6, T7, T8, T9, T10, T15, T20



Cr-V

WHK25-009-SERIE

Hex key wrench sets



Single item:

WHK01-size

WHK11-size

WHK210size



Cr-V

Contents

WHK2501-009 9pc - 1.5, 2, 2.5, 3, 4, 5, 6, 8, 10 mm (short)

WHK2511-009 9pc - 1.5, 2, 2.5, 3, 4, 5, 6, 8, 10 mm (long)

WHK2521-009 9pc - 1.5, 2, 2.5, 3, 4, 5, 6, 8, 10 mm (extra long)

WHK25BP-009-SERIE

Ball point hex key wrench sets



Single item:

WHK11BP-size

WHK21BP-size



Cr-V

Contents

WHK2511BP-009 9pc - 1.5, 2, 2.5, 3, 4, 5, 6, 8, 10 mm (long)

WHK2521BP-009 9pc - 1.5, 2, 2.5, 3, 4, 5, 6, 8, 10 mm (extra long)

WHK25T-009-SERIE

TX key wrench sets



Single item:

WHK01-size

WHK11-size

WHK210size



Cr-Mo

Contents

WHK2501T-009 9pc - T10, T15, T20, T25, T27, T30, T40, T45, T50 (short)

WHK2511T-009 9pc - T10, T15, T20, T25, T27, T30, T40, T45, T50 (long)

WHK2521T-009 9pc - T10, T15, T20, T25, T27, T30, T40, T45, T50 (extra long)

WHK25TP-009-SERIE

Tamperproof TX key wrench sets



Single item:

WHK2501TP-size

WHK2511TP-size

WHK2521TP-size



Cr-Mo

Contents

WHK2501TP-009 9pc - T10, T15, T20, T25, T27, T30, T40, T45, T50 (short)

WHK2511TP-009 9pc - T10, T15, T20, T25, T27, T30, T40, T45, T50 (long)

WHK2521TP-009 9pc - T10, T15, T20, T25, T27, T30, T40, T45, T50 (extra long)

WHKAT22H-009

High torque twist Hex key wrench XL



- Twisted design for increased torque
- Special slip-resistant coating
- Heat-treated Cr-V steel for maximum strength and durability

Contents:
1.5, 2, 2.5, 3, 4, 5, 6, 8, 10 mm (XL)



WTH-SERIE

Hex T-handle wrenches with ball point



WTH-T-SERIE

TX T-handle wrenches

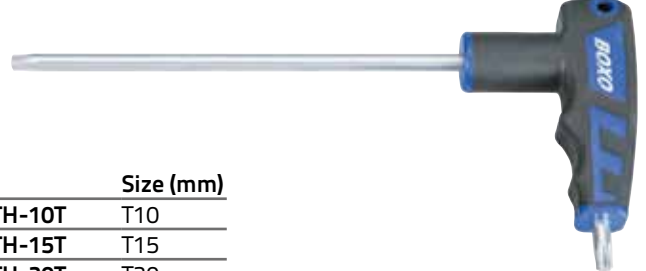
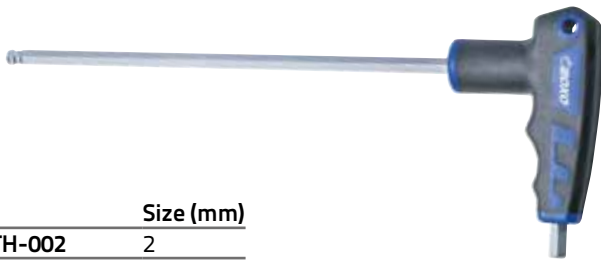

	Size (mm)
WTH-002	2
WTH-003	3
WTH-004	4
WTH-005	5
WTH-006	6
WTH-008	8
WTH-010	10
WTH-025	2.5

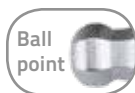

	Size (mm)
WTH-10T	T10
WTH-15T	T15
WTH-20T	T20
WTH-25T	T25
WTH-27T	T27
WTH-30T	T30
WTH-40T	T40
WTH-45T	T45
WTH-50T	T50



B-SD-BR08

1/4"

1/4" Stubby ratchet bit driver & bit set 7pc



Contents:
T15, T20, PH1, PH2, PH3, SL5.5, SL6.5



B-SD0038

1/4"

1/4" Ratchet screwdriver set 38pc



- 4-in 1 Flex ratchet bit driver handle
- Quick chuck bit system for rapid tool changes
- Integrated handle storage

Contents:
1/4" Sockets:
▪ 4, 5, 6, 7, 8, 9, 10, 11, 12, 13 mm

1/4" Bits (25 mm long):
▪ T8, T10, T15, T20, T25, T27, T30, T40
▪ PH0, PH1, PH2, PH3
▪ SL3, SL4.5, SL5.5, SL6.5, SL7
▪ H1.5, H2, H2.5, H3, H4, H5, H6



POWER TOOLS

AIR TOOLS

TOOL STORAGE

HAND TOOLS

WORKSHOP EQUIPMENT

SPECIALIST VEHICLE TOOLS

BH4281-1

1/4"

1/4" Bit set - Philips, Square



BH4281-2

1/4"

1/4" Bit set - Pozi, Hex ball point



BH4281-3

1/4"

1/4" Bit set - Hex



BH4281-4

1/4"

1/4" Bit set - Hex, XZN



BH4281-5

1/4"

1/4" Bit set - TX



LED-002

Magnet, mirror & LED lamp set 3pc



PLIERS

PR6540-010

Waterpump plier 250 mm

- 2-component grip



Length (mm)	250
Capacity (mm)	0 ~ 42

Cr-V

PR9540-SERIE

High-carbon C1080 steel waterpump pliers



- Boxo uses high-carbon C1080 steel for superior performance on the job and electronic coating for ultimate rust prevention
- Patented reinforcing edge minimizes stress breakage
- Undercut tongue & groove design won't slip
- Right-angle, laser-heat treated teeth grip better and last longer
- PermaLock® fastener eliminates nut and bolt failure

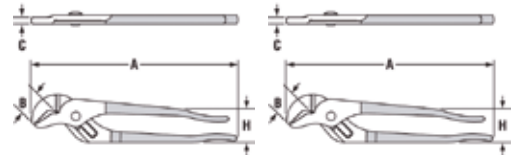

	Length (mm)	Capacity (mm)
U-PR9540-165	165	0 ~ 22
U-PR9540-203	200	0 ~ 38
U-PR9540-241	245	0 ~ 38
U-PR9540-254	250	0 ~ 51
U-PR9540-305	300	0 ~ 57
U-PR9540-419	420	0 ~ 108
U-PR9540-514	510	0 ~ 140



U-PR9541-241

Nutbuster tongue and groove plier 245 mm



- Boxo uses high-carbon C1080 steel for superior performance on the job and electronic coating for ultimate rust prevention
- Parrot Nose design ideal for round surfaces
- Unique SAFE-T-STOP® feature prevents finger pinch
- Unique double tongue & groove design won't slip
- PermaLock® fastener eliminates nut and bolt failures

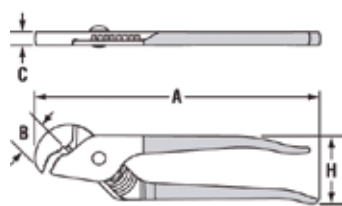

Length (mm)	245 mm
Capacity (mm)	0 ~ 28.5



U-PR9542-241

Griplock waterpump plier 245 mm



- Ergonomically designed offset head for greater leverage
- Special jaw design accommodates many shapes
- PermaLock® fastener eliminates nut and bolt failures

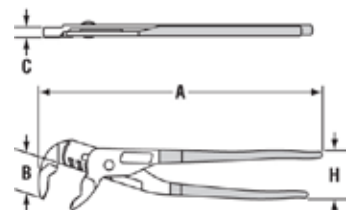

Length (mm)	245 mm
Capacity (mm)	0 ~ 32 mm



POWER TOOLS

AIR TOOLS

TOOL STORAGE

HAND TOOLS

WORKSHOP EQUIPMENT

SPECIALIST VEHICLE TOOLS

U-PR9511-152

Diagonal cutter 150 mm



- Box joint diagonal
- Laser heat-treated cutting edges last longer
- Boxo uses a knife and anvil style cutting edge to ensure perfect mating and superior cutting edge life
- Boxo uses a high-carbon C1080 steel for superior performance on the job and electronic coating for ultimate rust prevention



Length (mm)	150
Cutting capacity (mm)	1.5 / 2.0 (piano/steel wire)

PR6550-007

Diagonal cutter 180 mm



- 2-component grip



Cr-V

Length (mm)	180
Cutting capacity (mm)	2.0 / 2.5 (piano/steel wire)

U-PR9511-178

Diagonal cutter 175 mm

- Box joint diagonal
- Laser heat-treated cutting edges last longer
- Boxo uses a knife and anvil style cutting edge to ensure perfect mating and superior cutting edge life
- Boxo uses a high-carbon C1080 steel for superior performance on the job and electronic coating for ultimate rust prevention

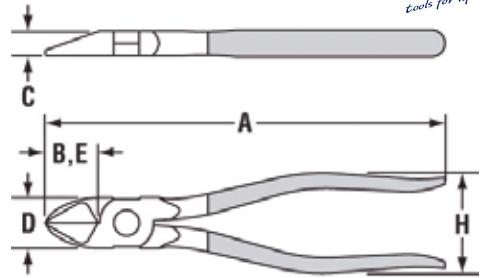

Length (mm)	175
Cutting capacity (mm)	2.5 / 3.0 (piano/steel wire)

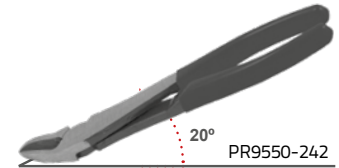

U-PR9550-242

Diagonal cutter 240 mm

- Box joint diagonal
- Laser heat-treated cutting edges last longer
- Boxo uses a knife and anvil style cutting edge to ensure perfect mating and superior cutting edge life
- Boxo uses a high-carbon C1080 steel for superior performance on the job and electronic coating for ultimate rust prevention

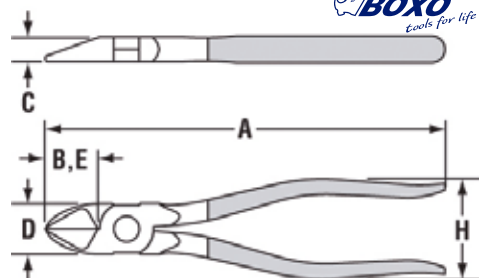

Length (mm)	240
Cutting capacity (mm)	3.0/3.5 (piano/steel wire)

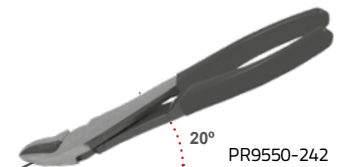

U-PR9590-158

End cutter plier 150 mm



- Laser heat-treated cutting edges last longer
- Boxo uses a knife and anvil style cutting edge to ensure perfect mating and superior cutting edge life
- Boxo uses a high-carbon C1080 steel for superior performance on the job and electronic coating for ultimate rust prevention

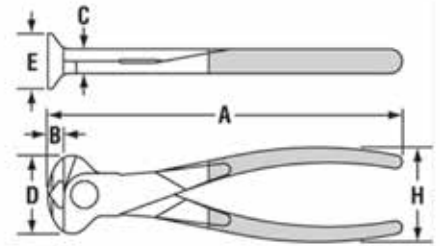

Length (mm)	150
Cutting capacity (mm)	1.5 / 2.0 (piano/steel wire)

U-PR9531-190

Combination plier 185 mm



- Cuts ASCR
- Laser heat-treated cutting edges last longer
- Boxo uses a knife and anvil cutting edge to ensure perfect mating and superior cutting edges life
- Useful gripping area
- Boxo uses high-grip carbon C1080 for superior performance on the job and electronic coating for ultimate rust prevention
- Improved High Leverage - moving the rivet closer to the cutter means considerably less force required for cutting

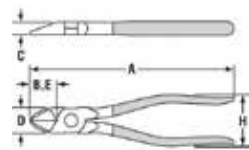

Length (mm)	185
Cutting capacity (mm)	2.5 / 3.0 (piano/steel wire)

PR6530-007

Combination plier 180 mm



- 2-component grip



Cr-V

Length (mm)	180
Cutting capacity (mm)	2.5 / 3.0 (piano/steel wire)

PRM-SERIE

Mini pliers



- 2-component grip

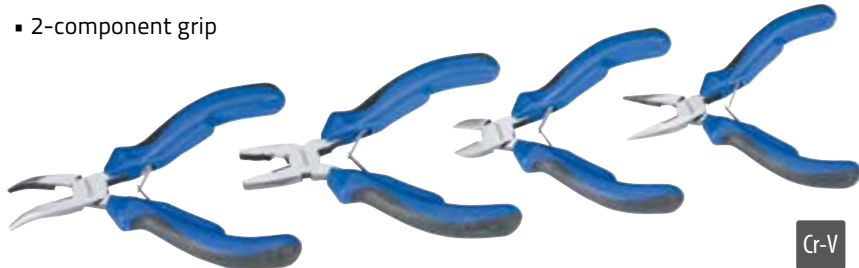

Cr-V

	Description	Length (mm)	Cutting capacity (mm)
PRM-B	Bent long nose plier	125	1.0/1.5 (piano/steel wire)
PRM-C	Combination plier	120	1.0/1.5 (piano/steel wire)
PRM-D	Diagonal cutter	115	1.0/1.5 (piano/steel wire)
PRM-L	Long nose plier	135	1.0/1.5 (piano/steel wire)



U-PR9510-152

XHL Diagonal plier 150 mm



- Extreme high leverage
- Crosshatch pattern on jaws grips work tightly

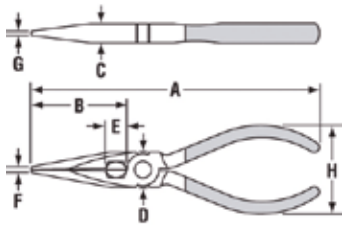

Length (mm)	150
Cutting capacity (mm)	1.5 / 2.0 (piano/steel wire)

U-PR9530-152

XHL Combination plier 150 mm



- Crosshatch pattern on jaws grips work tightly
- Extreme high leverage
- Suitable for cutting steel wire

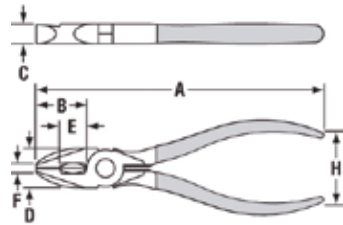

Length (mm)	150
Cutting capacity (mm)	1.5 / 2.0 (piano/steel wire)

U-PR9520-152

XHL Long nose plier 150 mm



- Suitable for cutting steel wire
- Extreme high leverage

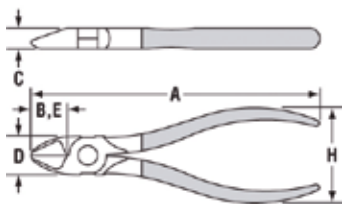

Length (mm)	150
Cutting capacity (mm)	1.5 / 2.0 (piano/steel wire)

U-PR9521-200

Long reach plier with flat nose 200 mm



- Flat nose
- Crosshatch teeth pattern
- Designed for long reach applications and hard to reach spaces
- Boxo uses high-carbon C1080 steel for superior performance on the job and electronic coating for ultimate rust prevention

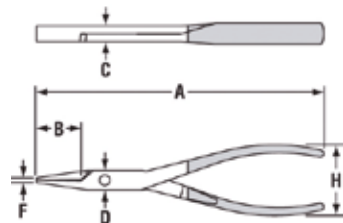

Length (mm)	200
-------------	-----

PR6520-008

Long nose plier 200 mm

- 2-component grip



Length (mm)	200
Cutting capacity (mm)	1.6 / 2.0 (piano/steel wire)

Cr-V

U-PR9520-203

High-carbon C1080 steel long nose plier 200 mm



- With side cutter Crosshatch pattern on jaws grips work tightly
- Boxo uses a knife and anvil style cutting edge to ensure perfect mating and superior cutting edge life
- Laser heat-treated cutting edges last longer
- Boxo uses high-carbon C1080 steel for superior performance on the job and electronic coating for ultimate rust prevention

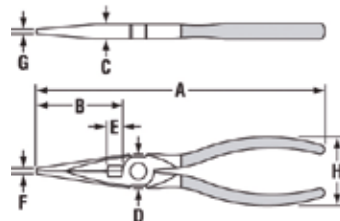

Length (mm)	200
Cutting capacity (mm)	1.6 / 2.0 (piano/steel wire)

U-PR9560-146

Bent long nose plier 150 mm

- Bent nose
- Crosshatch pattern on jaws grips work tightly
- Boxo uses a knife and anvil style cutting edge to ensure perfect mating and superior cutting edge life
- Boxo uses high-carbon C1080 steel for superior performance on the job and electronic coating for ultimate rust prevention

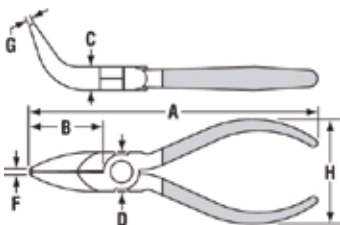

Length (mm)	150
-------------	-----

PRL-SERIE

XL Long nose pliers

- XL long nose plier straight
- XL long nose plier 45° bent
- XL long nose plier 90° bent



	Description	Length (mm)
PRL-45	45°	275
PRL-90	90°	275
PRL-ST	Straight	275

Cr-V

POWER TOOLS

AIR TOOLS

TOOL STORAGE

HAND TOOLS

WORKSHOP EQUIPMENT

SPECIALIST VEHICLE TOOLS

U-PR9210-241

Cable cutter 245 mm



- Cuts up to 4/0 aluminum and 2/0 copper
- Not for steel or ACSR
- Laser heat-treated cutting edges last longer
- Boxo uses a knife and anvil style cutting edge to ensure perfect mating and superior cutting edge life
- Boxo uses a high-carbon C1080 steel for superior performance on the job and electronic coating for ultimate rust prevention

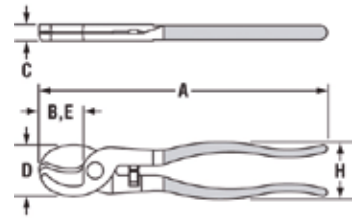

Length (mm)	245
-------------	-----

PR6710-007E

Plier with return spring, external 180 mm



- Retainer ring
- Vinyl coated



Capacity (mm)	12 ~ 65
Length (mm)	180

Cr-V

PR6710-007I

Plier with return spring, internal 180 mm



- Vinyl coated



Capacity	12 ~ 65 mm
Length	180 mm

Cr-V

PR6720-007E

90° Bent circlip plier with return spring, external 180 mm



- Vinyl coated



Capacity	12 ~ 65 mm
Length	180 mm

Cr-V

PR6720-007I

90° Bent plier with return spring, internal 180 mm



- Vinyl coated



Capacity	12 ~ 65 mm
Length	180 mm

Cr-V

HAMMERS

B-2241-2244

Ball pein hammer



	Head weight (g)	Length (mm)
B-2241	340	292
B-2242	450	330
B-2243	565	327
B-2244	900	385

HM7010-SERIE

Fitters hammer



Hickory

	Head weight (g)	Length (mm)
HM7010-300	300	300
HM7010-400	400	320
HM7010-500	500	320
HM7010-600	600	330
HM7010-800	800	350
HM7010-1000	1000	360

HM7110-035

Plastic hammer 300 mm



Double soft PU hammer

(HM7110-035RK) 35 mm head for HM7110-035



Ø (mm)	35
Length (mm)	300

HM7011-016

Plastic hammer 314 mm / 454 g



Combination of steel handle and impact resistant Urethane head



Headweight (g)	454
Length (mm)	314

HM7850-SERIE

Dead blow hammer



	Head weight (g)	Ø (mm)	Length (mm)
HM7850-035	400	35	260
HM7850-045	520	45	286
HM7850-055	1050	55	350
HM7850-065	1500	65	370



POWER TOOLS

AIR TOOLS

TOOL STORAGE

HAND TOOLS

WORKSHOP EQUIPMENT

SPECIALIST VEHICLE TOOLS

PR-AC1-0852

W-type plier



PR-AC2-0852

JJ-type plier



PR-AC3-0852

LL-type plier



PR-AC4-0852

J-type plier



PR-AC5-0852

L-type plier



PR6630-005

Curved jaw locking plier with wire cutter
 125 mm



Length 125 mm

PR6630-007

Curved jaw locking plier with wire cutter
 175 mm



Length 175 mm

PR6630-010

Curved jaw lock plier with wire cutter 250 mm



PR6640-006

Long nose locking plier 160 mm



Length 160 mm

PR6640-009

Long nose locking plier 225 mm



Length 225 mm

POWER TOOLS

AIR TOOLS

TOOL STORAGE

HAND TOOLS

WORKSHOP EQUIPMENT

SPECIALIST VEHICLE TOOLS

PP06BP

Pin punch set in a plastic holder 6pc

Contents:

- 2x115 mm
- 3x125 mm
- 4x150 mm
- 5x165 mm
- 6x180 mm
- 8x180 mm



PP-06-1MP

Pin punch set in a metal box 6pc

Contents:

- 2, 3, 4, 5, 6, 8 x 150 mm



PP-05BP

Punch and chisel set in a plastic holder 5pc

Contents:

- Pin Punch - 4x150 mm
- Taper Punch - 3x120 mm
- Centre Punch - 2x120 mm
- Caper Chisel - 5x130 mm
- Cold Chisel - 12x130 mm



PP-06-5MP

Combined set in a metal holder 6pc

Contents:

- Pin Punch - 4x50 mm
- Taper Punch - 3x120 mm
- Centre Chisel - 4x120 mm
- Cold Chisel - 12x125 mm, 16x150 mm
- Cape Chisel - 5x125 mm



PC28-SERIE

Punches and chisels



Description	Size (mm)
PC2851-5130 Caper chisel	5x130
PC2841-2120 Centre punch	2x120
PC2831-2220 Flat chisel	22x200
PC2831-1818 Flat chisel	18x180
PC2831-1618 Flat chisel	16x180
PC2831-1215 Flat chisel	12x150
PC2831-1014 Flat chisel	10x140
PC2821-6120 Drifft punch	6x120
PC2821-5120 Drifft punch	5x120
PC2821-4120 Drifft punch	4x120
PC2821-3120 Drifft punch	3x120
PC2811-8180 Pin Punch	8x180
PC2811-6180 Pin Punch	6x180
PC2811-5165 Pin Punch	5x165
PC2811-4150 Pin Punch	4x150
PC2811-3125 Pin Punch	3x125
PC2811-2115 Pin Punch	2x115



PC2861-0004-1

Automatic center punch 135 mm



AEN0098-18

Pry bar

- 450 mm



VG415

Precision hook & pick set 5pc



- Long fine tips
- Ideal for precision work in automotive/electronics
- Supplied in storage wallet

Contents:

- 1x straight
- 1x 45°
- 2x 90°
- Interchangeable holder



SIN-300.0015

Hook & pick set 4pc

- Ideal for various automotive applications including pin picking and removing hoses
- Length 270 mm

Contents:

- Awl
- Hook
- Bent tip 90° pick
- Curve tip pick



POWER TOOLS

AIR TOOLS

TOOL STORAGE

HAND TOOLS

WORKSHOP EQUIPMENT

SPECIALIST VEHICLE TOOLS

SIN-300.0030

Mini hook and pick set 4pc

- Blade: Stainless Steel
- Handle: black PVC
- Pouch bag
- Overall length: 180 mm
- Stainless tip: 73 mm
- Handle: 107 mm

Contents:

- Combination Pick
- 90° Pick
- Straight Pick
- Hook Pick



MT-SDE

Double ended scriber 240 mm



Diameter	4 mm
Length	240 mm

MT-SP

Scriber 150 mm



Diameter	4 mm
Length	150 mm

CUTK-178

Utility knife



- Ergonomic non-slip handle
- Quick open/close design
- Spare blade storage within handle



Spare blades (CUTK-B5)

CUTF-SERIE

Files

- Flat, half round, round, triangle and square



	Description	Length (mm)
CUTF-T08	Triangle file	200
CUTF-S08	Squar file	200
CUTF-R08	Round file	200
CUTF-HR08	Half round file	200
CUTF-F08	Flat file	200

PU-112086

Knife 9 mm



Length	9 mm
--------	------

CUTES-138

Multi-purpose scissor 138 mm

- Blade design
- Micro serrated



Length 138 mm



B-2202

Multi-purpose cutter

- Suitable for a range of shearing applications, including wire, rope and cardboard
- Blade design
- Micro serrated



Length 145 mm



B-2203

Cable cutter

- Multi-purpose cutter
- Suitable for a range of shearing applications, including cable ties, tape and insulation materials
- Blade design Micro serrated



Length 165 mm



B-2208

Mini tube cutter 3 ~ 25 mm

Specifically designed for easy operation



Diameter 13 mm
Spare blades (1pc) B-2208-1



B-2211

Multi-function wire stripper

- Fully automatic action - grips and strips in one go
- Adjustable cable strip length guide



Suitable for:

- Strip & cut cable/wire: 24 ~ 10 AWG / 0.25 mm² ~ 6 mm²
- Crimp insulated terminals: 22 ~ 10 AWG / 0.25 mm² ~ 5 mm²
- Crimp non-insulated terminals: 22 ~ 10 AWG / 0.25 mm² ~ 5 mm²
- Crimp ignition terminals: 7 ~ 8 / 8 mm² ~ 10 mm²



POWER TOOLS

AIR TOOLS

TOOL STORAGE

HAND TOOLS

WORKSHOP EQUIPMENT

SPECIALIST VEHICLE TOOLS

B-2204

Junior hacksaw 300 mm



- Ergonomic comfort-grip handles with non-slip finish



Length (mm)	300
Blade material	High carbon steel
Handle material	Steel/TPR

HS-300J

Junior hacksaw 150 mm



Length (mm)	150
Frame material	Square iron tube
Handle material	Aluminium

HS-300H

High tension hacksaw 300 mm



- Multi-angle adjustment: 0°, 45°



Length (mm)	300
Frame material	Square iron tube
Handle material	Aluminium

B-2206

Hacksaw 300 mm



- Multi-angle adjustment - 45°, 90°, 135°, 180°
- Blade storage in handle



Length (mm)	300
Blade material	Bi-metal
Handle material	ABS/TPR

MT-SPGS

Screw pitch gauges 22 blades 55°



Size (mm)	4 ~ 48
------------------	--------

MT-SPGM

Screw pitch gauge 24 blades 60°



Size (mm)	0.25 ~ 6
------------------	----------

MEASURING TOOLS

MT50019/80025

Tape measure

- Metric and Inch



	Width (mm)	Length (mm)
MT50019	19	5000
MT80025	19	8000

MT-FG

Feeler gauge 20 blades 005 - 10 mm



MT-VC

Vernier caliper 150 mm

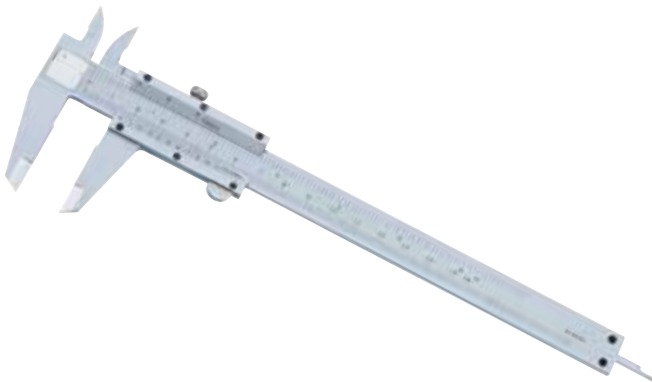

MT-SR

Steel ruler 300 mm



Length (mm)	300
Width (mm)	25
Thickness (mm)	1

MT-PR200

Plastic folding ruler 200 mm

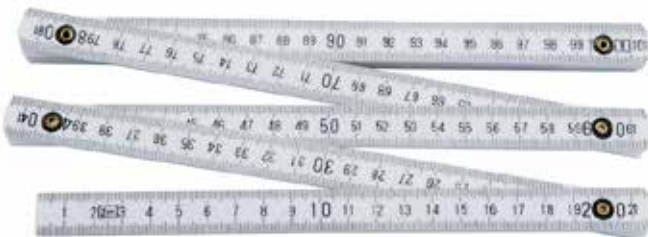

MT-PC

Circular protractor 150 mm



Length (mm)	150
Disc diameter (mm)	85

POWER TOOLS

AIR TOOLS

TOOL STORAGE

HAND TOOLS

WORKSHOP EQUIPMENT

SPECIALIST VEHICLE TOOLS

HU-HUS309A

Digital caliper 0 ~ 150 mm



- LCD display
- Zero setting at any position
- Metric/Inch system



Range (mm)	0 ~ 150
Resolution (mm)	0.01

X-SIN-200.0005

Angle meter with magnet



Degrees	360° CW or CCW
Accuracy	+/- 2%
Pre-setting memory	9
Signal	Buzzer + LEDs

VE473

Angular torque gauge



- Enables the user to rotate the fastener through a specified angle
- 360 degree scale clearly marked in 2 degree increments
- Easily zero the gauge by turning housing for next application

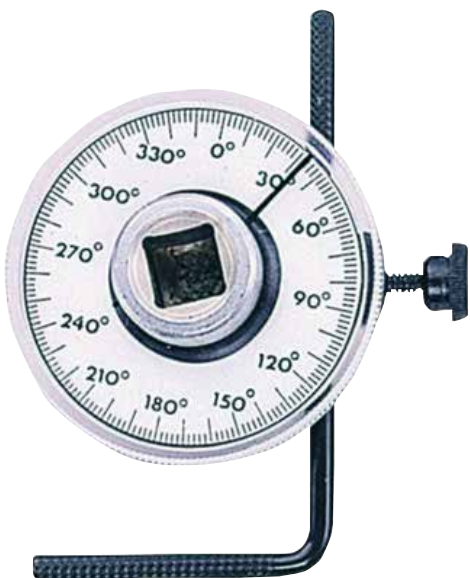

VDE TOOLS

SCWV-SERIE

VDE 1000 V Screwdriver in display box



DIN EN 60900

Contents

SCWV-7CB	Slotted - 3x100, 4x100, 5.5x125, 6.5x150 mm Phillips: PH0, PH1, PH2	7	
SCWV-6CB	Slotted - 3x100, 4x100, 6.5x150 mm Phillips - PH1, PH2, AC Test Screwdriver (110 ~ 250 V)	6	

BXI-012

VDE 1000 V Toolset in nylon pouch 12pc



- VDE 1000 V Slotted screwdrivers - 2.5x75 mm, 3x100 mm, 4x100 mm
- VDE 1000 V Phillips screwdrivers PH0x60 mm, PH1x80 mm
- VDE 1000 V Diagonal cutter 160 mm
- VDE 1000 V Combination plier 180 mm
- VDE 1000 V Cable knife
- PVC Insulating tape 20 m
- Mini diagonal cutter 115 mm
- Mini combination plier 120 mm
- Wire crimping tool



DIN EN 60900

BXI-S016

3/8"

3/8" VDE 1000 V insulated tool set 16pc



- VDE 1000 V 3/8" Reversible ratchet
- VDE 1000 V 3/8" Extension bars 150, 250 mm
- VDE 1000 V 3/8" Sliding T-bar
- VDE 1000 V 3/8" Sockets 8, 10, 12, 13, 14, 17, 19, 22 mm
- VDE 1000 V 3/8" Hex bit sockets 4, 5, 6, 8 mm
- Foam inlay



45

6pt

DIN EN 60900

BMC

BXI-S020

1/2"

1/2" VDE 1000 V insulated tool set 20pc



- VDE 1000 V 1/2" Reversible ratchet
- VDE 1000 V 1/2" Extension bars 125, 250 mm
- VDE 1000 V 1/2" Sliding T-bar
- VDE 1000 V 1/2" Sockets 10, 11, 12, 13, 14, 17, 19, 22, 24, 27, 32 mm
- VDE 1000 V 1/2" Hex bit sockets 4, 5, 6, 8, 10 mm
- Foam inlay



45

6pt

DIN EN 60900

BMC

POWER TOOLS

AIR TOOLS

TOOL STORAGE

HAND TOOLS

WORKSHOP EQUIPMENT

SPECIALIST VEHICLE TOOLS

BX031

2/3

BXI-016

VDE 1000 V Screwdriver & plier set 14pc



- VDE 1000 V Screwdrivers, Slotted - 3.x100, 4x100, 5.5x125, 6.5x150 mm
Phillips - PH0x60, PH1x80, PH2x100 mm
- Voltage tester (11 ~ 250 V)
- VDE 1000 V Diagonal cutter 160 mm
- VDE 1000 V HD diagonal cutter 180 mm
- VDE 1000 V Combination plier 180 mm
- VDE 1000 V Bent long nose plier 200 mm
- VDE 1000 V Long nose plier 200 mm
- VDE 1000 V Wire stripper 160 mm
- Foam inlay



DIN EN 60900

VDE 1000 V Insulated tool set in nylon bag 16pc



- VDE 1000 V Slotted screwdriver 4x100, 5.5x125, 6.5x150, 8x175 mm
- VDE 1000 V Phillips screwdriver PH1x80, PH2x100 mm
- VDE 1000 V Diagonal cutter 160 mm
- VDE 1000 V HD diagonal cutter 180 mm
- VDE 1000 V Combination plier 180 mm
- VDE 1000 V Wire stripper 160 mm
- VDE 1000 V Cable cutter 235 mm
- VDE 1000 V Adjustable wrench 215 mm
- VDE 1000 V Cable knife Insulating tape 20 m
- Voltage tester (12 ~ 690 V AC, DC)
- Folding ruler 2 m - ABS with Fibreglass



DIN EN 60900

U-BXI-033

3/8"

3/8" VDE 1000 V Insulated tool set in power case 33pc



- VDE 1000 V Slotted screwdriver 2.5x75, 3x100, 4x100, 5.5x125, 6.5x150, 8x175 mm
- VDE 1000 V Phillips screwdriver PH0x60, PH1x80, PH2x100 mm
- VDE 1000 V HD Diagonal cutter 180 mm
- VDE 1000 V Combination plier 180 mm
- VDE 1000 V Cable stripper 160 mm
- VDE 1000 V Cable cutter 235 mm
- VDE 1000 V Cable knife
- Voltage tester (12 ~ 690 V AC-DC)
- Wire crimping tool
- VDE 1000 V 3/8" Reversible ratchet
- VDE 1000 V 3/8" Extension bar 150, 250 mm
- VDE 1000 V 3/8" T-bar
- VDE 1000 V 3/8" Sockets 8, 10, 12, 13, 14, 17, 19, 22 mm
- VDE 1000 V Hex bit socket 4, 5, 6, 8 mm
- VDE 1000 V 3/8" Torque wrench 5-25 Nm
- Foam inlay
- Supplied in power case



DIN EN 60900



U-BXI-044

3/8"

3/8" VDE 1000 V Insulated tool set in nylon bag 41pc



- VDE 1000 V Open end wrench 7, 8, 10, 12, 14 mm
- Insulating tape 20 m
- Voltage tester (12 ~ 690 V DC, AC)
- Folding wooden ruler 2 m - ABS with fibreglass
- VDE 1000 V 3/8" Sockets 8, 10, 12, 13, 14, 17, 19, 22 mm
- VDE 1000 V 3/8" Hex bit socket 4, 5, 6, 8 mm
- VDE 1000 V 3/8" Reversible ratchet
- VDE 1000 V 3/8" Extension bar 150, 250 mm
- VDE 1000 V 3/8" T-bar
- VDE 1000 V Slotted screwdriver
- 3x100, 4x100, 5.5x125, 6.5x150, 8x175 mm
- VDE 1000 V Phillips screwdriver
- PH0x60, PH1x80, PH2x100 mm
- VDE 1000 V Diagonal cutter 160 mm
- VDE 1000 V HD diagonal cutter 180 mm
- VDE 1000 V Combination plier 180 mm
- VDE 1000 V Wire stripper 160 mm
- VDE 1000 V Cable cutter 235 mm
- VDE 1000 V Adjustable wrench 215 mm
- VDE 1000 V Long nose plier round 160 mm
- VDE 1000 V Cable knife
- Voltage tester (6 ~ 24 V DC)
- Foam inlay



POWER TOOLS

AIR TOOLS

TOOL STORAGE

U-BXI-038

3/3

3/3

3/8"

3/8" VDE 1000 V Insulated tool set for hybrid vehicles 38pc



- VDE 1000 V Screwdriver slotted, 2.5x75 mm, 3x100 mm, 4x100 mm, 5.5x150 mm, 6.5x150 mm, 8x175 mm
- VDE 1000 V Phillips screwdriver PH0x60 mm, PH1x80 mm, PH2x100 mm
- VDE 1000 V Diagonal cutter 160 mm VDE 1000 V HD diagonal cutter 180 mm
- VDE 1000 V Combination plier 180 mm
- VDE 1000 V Wire stripper
- VDE 1000 V Long nose pliers - rounded
- VDE 1000 V Cable cutter 235 mm
- Crimping plier
- VDE 1000 V Adjustable wrench 215 mm
- VDE 1000 V Cable knife
- Insulating tape 20 m
- Voltage tester (12 ~ 690 V DC, AC)
- Folding ruler 2 m - ABS with Fibreglass
- VDE 1000 V 3/8" Sockets 8, 10, 12, 13, 14, 17, 19, 22 mm
- VDE 1000 V 3/8" Hex bit socket 4, 5, 6, 8 mm
- VDE 1000 V 3/8" Reversible ratchet
- VDE 1000 V 3/8" Torque wrench (5 ~ 25 Nm)
- VDE 1000 V 3/8" Extension bar 150, 250 mm
- VDE 1000 V 3/8" Sliding T-bar
- Foam inlay



HAND TOOLS

WORKSHOP EQUIPMENT

SPECIALIST VEHICLE TOOLS

SCWT-L690V

Universal voltage tester 12 ~ 690 V

- Can test an entire circuit from the battery to the component in question
- Determine if the relay itself is functioning properly
- Instantly determine the problem within the circuit
- No need of a multimeter : just push the button
- Features easily accessible ports for use with other diagnostic tools for further diagnostic
- Can be used as a remote control starter in engine work like compression testing, distributor or cam shaft adjusting, to run the compressor etc.



SCWT

110 ~ 250 V Voltage tester



SCW1611-V-SERIE

VDE 1000 V slotted screwdriver

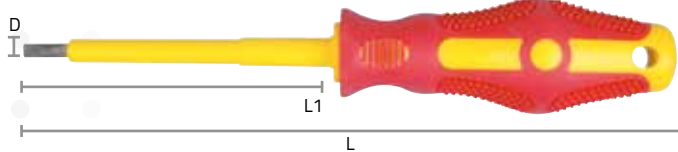

SCW1621-V-SERIE

VDE 1000 V philips screwdriver

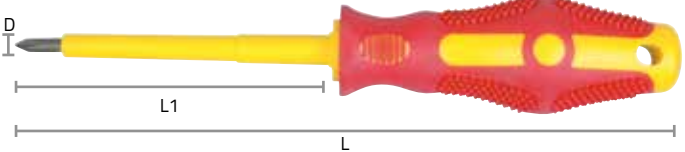

	Size (mm)	L (mm)	L1 (mm)	D (mm)
SCW1611-65150V	6.5	260	150	6.5
SCW1611-55125V	5.5	225	125	5.5
SCW1611-04100V	4	200	100	4
SCW1611-03100V	3	170	100	3



	Size	L (mm)	L1 (mm)	D (mm)
SCW1621-02100V	PH2	210	100	6
SCW1621-01080V	PH1	180	80	4.5
SCW1621-00060V	PH0	130	60	3



WR1013I-010

VDE 1000 V Adjustable wrench 215 mm



WR1720I-SERIE

VDE 1000 V Open end spanners



	Size (mm)
WR1720I-014	14
WR1720I-012	12
WR1720I-010	10
WR1720I-008	8
WR1720I-007	7



PR6510I-006

VDE 1000 V diagonal cutter 160 mm



Cutting capacity	1.6 mm
Length	160 mm



PR6550I-007

VDE 1000 V HD diagonal cutter 180 mm



Cutting capacity	2.5 ~ 3.0 mm
Length	180 mm



PR6530I-007

VDE 1000 V Combination plier 180 mm



Cutting capacity	1.6 mm
Length	180 mm



PR6520I-008

VDE 1000 V long nose plier 200 mm



Cutting capacity	1.6 mm
Length	200 mm



PR6560I-008

VDE 1000 V Bent long nose plier 200 mm



Cutting capacity	1.6 mm
Length	200 mm



CUTCS-205

Crimping plier- wire stripper - 205 mm



POWER TOOLS

AIR TOOLS

TOOL STORAGE

HAND TOOLS

WORKSHOP EQUIPMENT

SPECIALIST VEHICLE TOOLS

PR6570I-006

VDE 1000 V Wire stripper 160 mm



Cutting capacity	0.5 ~ 4.0 mm
Length	160 mm



PRCCI-011

VDE 1000 V Cable cutter 235 mm



- For cutting Cu- and Al- multi wire cable
- Not for steel wire
- 235 mm



CUTKI-06

VDE 1000 V Cable knife/stripper



- Narrow, fixed hook blade



IT-19X20

Insulation tape 0.2mmx19mmx20m



X-TWINS-25N

3/8" VDE 1000 V Torque wrench



- 5 ~ 25 Nm



CAULKING GUNS

SIN-900.0405

Single component caulking gun 310 ml



- Two gripper plates
- 360° rotary type Handle
- Aluminum handle / Metal trigger
- Riveted & reinforced carriage
- With Built-in puncture tool
- Patented adjustable screw to cut thrust gaps
- High-performance drive (Easy on hand)
- Suitable for high viscosity sealant
- Suitable for cold weather



Capacity	310 ml
Thrust ratio	18:01

SIN-900.0410

Single component caulking gun 310, 400 ml



- Aluminum barrel
- Aluminum handle / metal trigger
- Two gripper plates
- With Built-in puncture tool
- Patented adjustable screw to cut thrust gaps
- High-performance drive (Easy on hand)
- Suitable for high viscosity sealant
- Suitable for cold weather
- Patented adjustable screw to cut thrust gaps



Capacity	310, 400 ml
Thrust ratio	18:01

SIN-900.0415

Single component caulking gun 310, 400 & 600 ml



- Aluminum barrel
- Aluminum handle / metal trigger
- Two gripper plates
- With Built-in puncture tool
- Patented adjustable screw to cut thrust gaps
- High-performance drive (Easy on hand)
- Suitable for high viscosity sealant
- Suitable for cold weather
- Patented adjustable screw to cut thrust gaps



Capacity	310, 400, 600 mm
Thrust ratio	18:01



POWER TOOLS

AIR TOOLS

TOOL STORAGE

HAND TOOLS

WORKSHOP EQUIPMENT

SPECIALIST VEHICLE TOOLS

WORKSHOP EQUIPMENT



POWERHAND®
POWER FOR PROFESSIONALS

Powerhand lights are well regarded as offering both high quality and excellent value. From pocket lights, to work lamps and specialist lighting such as under bonnet and flood lights, the Powerhand range is designed especially with both the workshop professional and roadside recovery operator in mind. All Powerhand lighting comes with a 12 month warranty.

GOJAK™
THE FASTER CASTER SYSTEM™

GoJak was designed to improve vehicle movement and repositioning in workshops, showrooms and body shops but is also invaluable in car parks and to a multitude of rescue services. To overcome different axle widths, wheelbases, wheel sizes and tyre widths, every GoJak is self-loading. GoJak's are mechanical, therefore very quick and simple to use without the obvious hazard of leaking hydraulics. This system makes lifting and moving vehicles in any direction very quick and easy saving both time and money. With four models available an immense range of vehicles weighing up to 2.2820 kg can be 'lifted & shifted'.

RAKJAK™

RakJak is the preferred air jack for use on frame racks, alignment machines, for emergency road services and in a variety of repair shops. Every RakJak is compact, powerful, super-fast in use and virtually maintenance free. For additional safety and peace of mind every RakJak has a unique internal stabilizer that provides lateral and vertical stability. RakJak is simply the easiest and quickest way to lift any vehicle weighing up to 3 tons.

POWER-START™

Power-Start is manufactured in the UK and designed specifically for the professional user, the Power-Start high rate jump start pack is suitable for starting most 12 V and 12 V and 24 V engines - automotive, air, marine and rail. With safety in mind, each starter pack incorporates many safety features. Reverse polarity warning reduces the risk of wrongful connection whilst spike protection circuits reduce the risk of damage to the vehicle on-board electronic systems. The on/off isolator switch ensures a safe connection due to nonOlive cable clamps and also avoids unintentional short circuit. Manufactured by a company with NATO certification, it's not surprising that Power-Start is the professionals choice.

Schumacher
ELECTRIC

Since 1947, Schumacher Electric Corporation has been leading change and driving performance to exceed its customers' expectations. Engineered patent-pending technologies and award-winning marketing makes Schumacher the brand of choice. Schumacher's legacy is its commitment to quality and exceptional customer service. Schumacher brings experience, innovation and excellence to the next generation of battery maintenance. Schumacher Electric Corporation is the USA's largest manufacturer of battery chargers—making more than 4-million units annually. In the North American market, Schumacher Electric's share of this category is approximately 81%.

SYMBOL GUIDE



2 year warranty Schumacher



Tested by Dekra



Microprocessor controlled



3x faster



Eco friendly

SUB-SECTIONS

202 FLASH LIGHTS
203 HEAD LAMPS
204 PEN LIGHTS
205 WORK LAMPS
208 WORK LAMPS AND SPECIALIST LIGHTS
209 SPECIALIST LIGHTS
212 ACCESSORIES
213 SOLDERING
214 INDUCTION

216 AIR JACKS
220 SELF LOADING DOLLIES
226 MATS AND SEAT COVERS
227 JUMP STARTERS
232 ACCESSORIES
234 BATTERY TOOLS
236 BATTERY CHARGERS
240 GENERAL WORKSHOP TOOLS

LEDs and how they work

LED basics

Different LED types



	LED	SMD LED	COB LED
Consumption	0.1 W	0.5 W	1 W
Beam angle (degree)	30°	120°	120°
Light output	< 10 lumen	< 20 lumen	~ 100 lumen
Working temperature	-20 ~ 50° C	-20 ~ 50° C	-20 ~ 50° C

Difference between lux and lumen

Lumen (lm)

Total amount of visible light present in all directions

Lux (lx)

Licht beam spread over a given area

1 lux = 1 lumen per m²

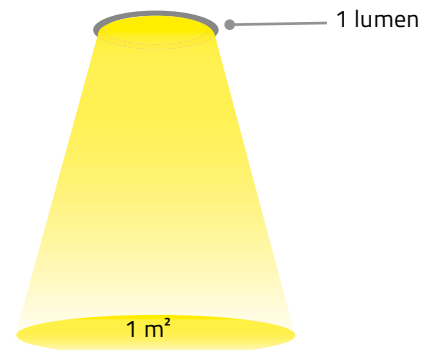

Colour Temperature (Kelvin Temperature Chart)

Colour temperature is a characteristic of visible light that has important applications in lighting, photography, videography, publishing, manufacturing, astrophysics and other fields. The colour temperature of a light source is the temperature of an ideal black-body radiator that radiates light of comparable hue to that light source. The temperature is conventionally stated in units of absolute temperature, known as Kelvin (K).

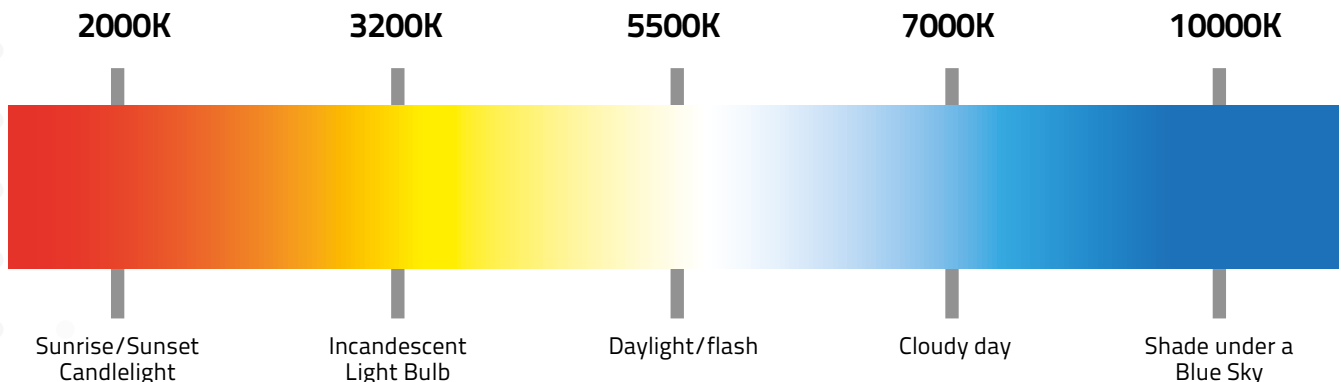

LEDs AND HOW THEY WORK

IP Rating (first digit solids, second digit liquids)

Solids

Level	Object size
IP1X	>50 mm
IP2X	>12.5 mm
IP3X	>2.5 mm
IP4X	>1 mm
IP5X	Dust protected
IP6X	Dust tight

Liquids

Level	Protected against
IPX0	Not protected
IPX1	Dripping water
IPX2	Dripping water when tilted up to 15°
IPX3	Spraying water
IPX4	Splashing water
IPX5	Water jets
IPX6	Powerful water jets
IPX7	Immersion up to 1 m
IPX8	Immersion beyond 1 m



SIN-100.0035

IP42 = Solids > 1 mm and protected against dripping water when tilted up to 15°
IK04 = Protected against 0.5 joules impact dropped from 200 mm above surface



SIN-100.2010

IP54 = Dust protected and protected against splashing water
IK07 = Protected against 2 joules impact dropped from 400 mm above surface

IK Rating (protection for electrical equipment against external mechanical impacts)

IK01	Protected against 0.14 joules impact dropped from 75 mm above surface	Force equals 0.2 kg
IK02	Protected against 0.2 joules impact dropped from 80 mm above surface	Force equals 0.2 kg
IK03	Protected against 0.35 joules impact dropped from 140 mm above surface	Force equals 0.2 kg
IK04	Protected against 0.5 joules impact dropped from 200 mm above surface	Force equals 0.2 kg
IK05	Protected against 0.7 joules impact dropped from 280 mm above surface	Force equals 0.2 kg
IK06	Protected against 1 joules impact dropped from 400 mm above surface	Force equals 0.5 kg
IK07	Protected against 2 joules impact dropped from 400 mm above surface	Force equals 0.5 kg
IK08	Protected against 5 joules impact dropped from 300 mm above surface	Force equals 1.7 kg
IK09	Protected against 10 joules impact dropped 200 mm above surface	Force equals 5 kg
IK10	Protected against 20 joules impact dropped 400 mm above surface	Force equals 5 kg

SIN-100.2020

3.7 V

Micro USB rechargeable penlight with clip 80 Lumen (aluminium)

- Rechargeable true view work lamp with COB LED technology
- COB LEDs provide 80, 40, 5 Lumen
- Long life LEDs (life span 100.000 hours)
- Battery charge level indicator for easy monitoring
- Lamp use is not affected by cold temperatures
- Cordless design improves safety, convenience and flexibility
- 3.7 V 0.35 Ah Li-Ion battery provides 1 ~ 4 hours constant light output
- Focus function
- IP54 rated
- IK07 rated
- Robust, shock resistant aluminium housing



Focus function



POWERHAND®
POWER FOR PROFESSIONALS

Battery	3.7 V 0.35 Ah Li-Ion
Brightness	5/40/80 Lumen
Color temperature	6500 K
Charger	5 V 1 A
Dimensions	Ø 16x149 mm
IP rating	IP54
LED	6 SMD
Material	Aircraft grade aluminium
Max. run time	4 Hours
Operating temperature	-20 ~ 50°C
Shock resistance	IK07

SIN-100.2030

3.7 V

USB rechargeable Aluminium flashlight 800 Lumen

- Professional rechargeable flashlight with CREE technology
- CREE LEDs provide 800/200 Lumen
- Strobe function
- Long life LEDs (life span 100.000 hours)
- Focus function
- PowerBank function
- Cordless design improves safety, convenience and flexibility
- Lamp use is not affected by cold temperatures

- Made with high-quality materials for optimal use and durability
- 3.7 V 2.6 Ah Li-Ion battery provides 3 hours constant light output
- IP54 rated
- IK07 rated
- Robust, shock resistant aluminium housing
- High-quality aluminium
- Strong magnet: 24 ~ 30 N



Xtreme
BRIGHTNESS
800 LUMEN



SIN-100.2010

3.7V

USB rechargeable COB headlight 150 Lumen

- Rechargeable headlight with COB technology
- COB LEDs provide 50/150 Lumen
- Long life LEDs (life span 100.000 hours)
- With motion sensor - allows hands to operate the light by waving right in front of the the light
- Adjustable head strap
- Wide beam distribution lens
- Strobe function
- Lamp use is not affected by cold temperatures
- Made with high-quality materials for optimal use and durability
- 3.7 V 2.2 Ah Li-Ion battery provides 4 hours constant light output
- IP54 rated
- IK07 rated
- Robust, shock resistant housing
- Adjustable lamp tilts 180°



POWERHAND®
POWER FOR PROFESSIONALS

Battery	3.7 V 2.2 Ah Li-Ion
Beam distance	8 ~ 20 m
Brightness	75 - 150 Lumen
Color temperature	6000 K
Charger	5 V 1 A
Charging time	5 Hour(s)
Dimensions	77x40x30 mm
IP rating	IP54
Material	ABS
Max. run time	12 Hours
Operating temperature	-20 ~ 50°C
Shock resistance	IK07



COB LED

POWER TOOLS

AIR TOOLS

TOOL STORAGE

HAND TOOLS

WORKSHOP EQUIPMENT

SPECIALIST VEHICLE TOOLS

SIN-100.1009

3.7 V

Aluminum SMD inspection lamp 250 Lumen

- Swivel clip
- Magnet

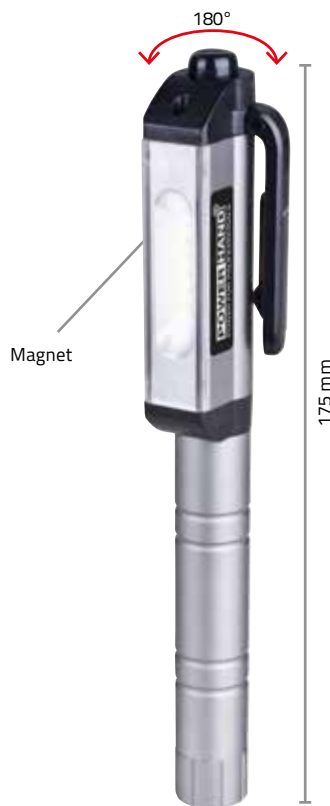

Super
Bright
SMD
Technology



SIN-100.1009D

POWERHAND®
POWER FOR PROFESSIONALS

Battery	3x HD AAA
Brightness	250 Lumen
Color temperature	6500 K
IP rating	IP20
LED	6 SMD
Max. run time	4 Hour(s)
Operating temperature	-20 ~ 50°C
Shock resistance	IK07



SIN-100.1010-SERIE

3.7 V

Micro USB rechargeable inspection lamp 120 Lumen

- Broad 90° light spread
- IP20 rated
- IK07 rated
- Low power consumption, low heat emission
- Lamp use is not affected by cold temperatures
- Long life SMDs (life span 100.000 hours)
- Cordless design improves safety, convenience and flexibility
- 3.7 V 0.75 Ah Li-Ion battery provides 2.5 hours constant light output (main), 4.5 hours constant light output (spot)
- Made with high-quality materials for optimal use and durability
- Robust, shock resistant housing

Super
Bright
SMD
Technology



POWERHAND®
POWER FOR PROFESSIONALS

Battery	3.7 V 0.75 Ah Li-Ion
Brightness	120 Lumen
Brightness spot	80 Lumen
Charger	5 V
Charging time	2.5 Hour(s)
Dimensions	Ø 22x168 mm
IP rating	IP20
LED	SMD
Material	ABS
Max. run time	2.5 Hour(s)
Max. run time spot	4.5 Hour(s)
Operating temperature	-20 ~ 50°C
Shock resistance	IK07

SIN-100.1010 = black
SIN-100.1010Y = yellow
SIN-100.1010R = red



SIN-100.2026-SERIE

3.7 V

Micro-USB rechargeable LED worklamp Li-Ion

- SMD LEDs provide 350 Lumen
- SMD LED spot provide 80 Lumen
- Long life SMDs (life span 100.000 hours)
- 2x 360° Integrated swivel hook
- 3 Integrated magnets (2x 5 N, 1x 50 N)
- 180° forward/backward swivel
- Low power consumption, low heat emission
- Battery charge indicator
- Lamp use is not affected by cold temperatures
- Cordless design improves safety, convenience and flexibility
- 3.7 V 2 Ah Li-Ion battery provides 3 and 7 hours constant light output

**Super
BRIGHT
350
LUMEN**

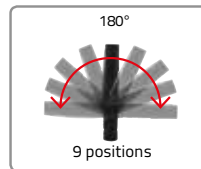

POWER HAND[®]
POWER FOR PROFESSIONALS

Battery	3.7 V 2 Ah Li-Ion
Brightness	350 Lumen
Brightness spot	80 Lumen
Color temperature	6500 K
Color temperature spot	9300 K
Charging time	5 Hour(s)
Dimensions	56x46x250 mm
IP rating	IP20
LED	SMD
Material	ABS
Max. run time	3 Hour(s)
Max. run time spot	7 Hour(s)
Operating temperature	-20 ~ 50°C
Shock resistance	IK04

SIN-100.2026 = black
SIN-100.2026-B = blue
SIN-100.2026-O = orange
SIN-100.2026-R = red
SIN-100.2026-Y = yellow



POWER TOOLS

AIR TOOLS

TOOL STORAGE

HAND TOOLS

WORKSHOP EQUIPMENT

SPECIALIST VEHICLE TOOLS

SIN-100.1045

3.7 V

Micro-USB rechargeable COB work lamp with laser pointer Li-Ion

- Hanging hook
- Magnet
- USB-charger
- Pocket clip
- Charge indicator
- ABS housing

LASER
pointer



150
LUMEN



POWERHAND®
POWER FOR PROFESSIONALS

Battery	3.7 V 1.1 Ah Li-Ion
Brightness	150 Lumen
Charging time	2.5 Hour(s)
Color temperature	6500 K
IP rating	IP54
LED	2W COB LED
Dimensions	Ø 51x160 mm
Max. run time	3.5 Hour(s)
Max. run time spot	5 Hour(s)
Operating temperature	-10 ~ 40°C
Shock resistance	IK07

COB
Technology

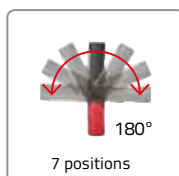

2W COB	150 Lumen	80 Lumen	IP54	IK07
35 N	2.5 H	3.5-5 Hours	0.180 kg	3.7 V, 1.1 Ah
				-20-50°C

SIN-100.1035-SERIE

3.6 V

Multi-function work inspection lamp

- COB LEDs provide: 400
- SMD LED provide: 100 Lumen
- Long life LEDs (life span 100.000 hours)
- 360° Integrated swivel hook
- 180 forward/backward swivel
- Cordless design improves safety, convenience and flexibility
- Lamp use is not affected by cold temperatures
- Made with high-quality materials for optimal use and durability
- Battery charge level indicator for easy monitoring
- IP42 rated
- IK04 rated

- Robust, shock resistant ABS housing
- Broad 90° light spread
- Strong magnet: 38 N

Super
Bright
SMD
Technology

POWERHAND®
POWER FOR PROFESSIONALS

Battery	3.6 V 2.6 Ah Li-Ion
Brightness	400 Lumen
Brightness spot	100 Lumen
Charging time	5 Hour(s)
Color temperature	5700 K
IP rating	IP42
LED	5W COB
LED spot	1W SMD
Dimensions	283x36x25 mm
Max. run time	3 Hour(s)
Max. run time spot	7 Hour(s)
Operating temperature	-20 ~ 50°C
Shock resistance	IK04

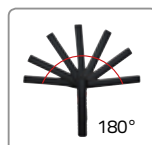
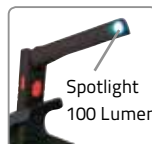

SIN-100.1035 = black
SIN-100.1035-B = blue
SIN-100.1035-O = orange
SIN-100.1035-R = red
SIN-100.1035-Y = yellow

5W COB 1W SMD	400 Lumen	100 Lumen	IP42	IK04
5700 K	5 H	3H /spot 7 H	0.170 kg	3.6 V, 2.6 Ah
				-20-50°C

SIN-100.1060

3.7 V

Rechargeable 3-in-1 Li-Ion-inspection lamp 350 Lumen

- Innovative worklamp with 3 in 1 quick connection
- Flashlight (Torch) with focus
- Flexlight with focus
- Slimlight with 180° swivel
- Power indicator switch
- 78 N strong magnet in the base
- Cordless design improves safety, convenience and flexibility
- 3.7 V 2.2 Ah Li-Ion battery provides 2.5 ~ 8 hours constant light output
- Made with high-quality anodized aluminium for reduced weight and extra strength
- Car charger

POWERHAND®
POWER FOR PROFESSIONALS

Battery	3.7 V 2.2 Ah Li-Ion
Brightness	100 ~ 350 Lumen
Beam distance	35 ~ 150 m
Color temperature	5800 ~ 6500 K
Dimensions	Ø 35x191/363/552 mm
IP rating	IP54
LED	COB - CREE
Max. run time	2.5 Hour(s)
Max. run time spot	8 Hour(s)
Material	Anodized aluminium
Operating temperature	-20 ~ 50 ° C
Shock resistance	IK07



SIN-100.1070

3.7 V

Professional rechargeable workshop lamp with top light and battery status indicator

- Professional rechargeable workshop lamp with COB and SMD LED technology
- COB LEDs provide 60 ~ 600 Lumen
- Rotating dimmer switch
- Ball joint magnetic base, can be rotated 360° with a 42° tilt
- 210° Integrated swivel hook
- Low power consumption, low heat emission
- Battery charge level indicator for easy monitoring
- Lamp use is not affected by cold temperatures
- Cordless design improves safety, convenience and flexibility
- Diffuser lens for softer light and reduced shadow
- Robust, shock resistant housing
- Broad 120° light spread
- IP54 rated
- IK07 rated

POWERHAND®
POWER FOR PROFESSIONALS

Battery	3.7 V 2.2 Ah Li-Ion
Brightness	60 ~ 600 Lumen
Brightness spot	120 Lumen
Charging time	4 Hour(s)
Color temperature	6500 K
Dimensions	384x40x44.5 mm
IP rating	IP54
LED	COB - SMD
Max. run time	2 ~ 16 Hour(s)
Max. run time spot	10 Hour(s)
Material	ABS
Operating temperature	-20 ~ 50 ° C
Shock resistance	IK07



SIN-100.2001BR

3.7V

Rechargeable workshop lamp 700 Lumen with COB and SMD technology

- Professional rechargeable workshop lamp with COB and SMD LED technology
- COB LEDs provide: 700 / 300 / 175
- SMD LED provide: 150 Lumen
- Long life LEDs (life span 100.000 hours)
- 360° Integrated swivel hook
- 180 forward/backward swivel
- Cordless design improves safety, convenience and flexibility
- Lamp use is not affected by cold temperatures
- Battery charge level indicator for easy monitoring
- Made with high-quality materials for optimal use and durability
- 3.7 V 2.6 Ah Li-Ion battery provides 2 - 7 hours constant light output
- Robust, shock resistant housing
- IP65 rated
- IK07 rated
- Broad 50° light spread
- Strong magnet: 52 N

**700
LUMEN**

**Super
Bright
COB
Technology**

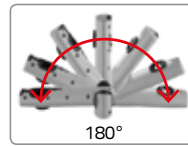

POWERHAND®
POWER FOR PROFESSIONALS

Battery	3.7 V 2.2 Ah Li-Ion
Brightness	175 - 300 - 700 Lumen
Brightness spot	150 Lumen
Charging time	5 Hour(s)
Color temperature	6500 K
Dimensions	59x41.5x230 mm
IP rating	IP54
LED	6W COB s
Max. run time	7 Hour(s)
Max. run time spot	7 Hour(s)
Operating temperature	-20 ~ 50 ° C
Shock resistance	IK07



SIN-100.1019

3.7V

Rechargeable SMD under bonnet light 1000 Lumen

- SMD LEDs provide 500 / 1000 Lumen
- Low power consumption, low heat emission
- Extendable for application's between 115 up to 180 cm
- Dual 360° soft padded swivel hooks for flexible light positioning
- Battery charge level indicator for easy monitoring
- Lamp use is not affected by cold temperatures
- Cordless design improves safety, convenience and flexibility
- 3.7 V 4.4 Ah Li-Ion battery provides 3-6 hours constant light output
- Made with high-quality aluminium for reduced weight and extra strengt
- Diffuser lens for softer light and reduced shadow
- IP65 rated
- IK08 rated

**Super
Bright
SMD
Technology**



POWERHAND®
POWER FOR PROFESSIONALS

Battery	3.7 V 2.2 Ah Li-Ion
Brightness	500 - 1000 Lumen
Charging time	5 Hour(s)
Color temperature	5650 ~ 6500 K
Dimensions	1153x67x86 mm
IP rating	IP65
LED	6W COB s
Max. run time	6 Hour(s)
Material	Anodized aluminium
Operating temperature	-20 ~ 50 ° C
Shock resistance	IK08

- Robust, shock resistant aluminium housing
- Dazzle free
- Broad 120° light spread



SIN-100.1030

3.7 V

Micro-USB rechargeable UV LED work lamp Li-Ion

- Hanging hook
- Magnet
- USB-charger + Charging station
- Pocket clip
- Charge indicator
- ABS housing

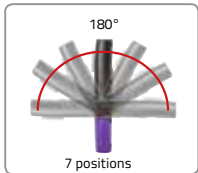

Super
Bright
UV
Technology



HIGH OUTPUT
UV
LEAK DETECTION

POWER HAND®
POWER FOR PROFESSIONALS

Battery	3.7 V 2.6 Ah Li-Ion
Charger	100 ~ 240 V / 5 V 1 A
Charging time	4 Hour(s)
IP rating	IP65
LED	5W UV LED 390 ~ 405 nm, Ra=10
Dimensions	190x56x35 mm
Max. run time	4.5 Hour(s)
Operating temperature	-10 ~ 40°C
Shock resistance	IK07
Width	56 mm



SIN-100.2040

3.7 V

Rechargeable true view COB LED work lamp 500 Lumen

- Rechargeable true view work lamp with COB and SMD LED technology
- COB LEDs provide 110, 220, 500 Lumen
- SMD LEDs provide 150 Lumen
- Long life LEDs (life span 100.000 hours)
- 360° Integrated swivel hook
- 180° forward/backward swivel
- Low power consumption, low heat emission
- Battery charge level indicator for easy monitoring
- Lamp use is not affected by cold temperatures
- Cordless design improves safety, convenience and flexibility

- 3.7 V 2.6 Ah Li-Ion battery provides 1.5 - 7 and 7 hours constant light output
- Diffuser lens for softer light and reduced shadow
- Robust, shock resistant housing
- IP65 rated
- IK07 rated
- 50° light spread

True view
colour match



RA >95+
4500 K
True colour

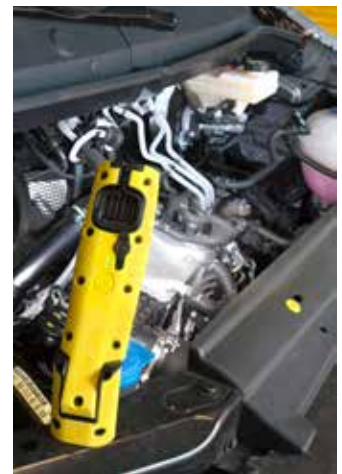
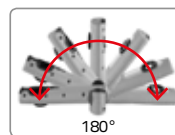

POWER HAND®
POWER FOR PROFESSIONALS

Battery	3.7 V 2.6 Ah Li-Ion
Brightness	110 - 220 - 500 Lumen
Brightness spot	150 Lumen
Charger	100 ~ 240 V / 5 V 1 A
Charging time	4.5 Hour(s)
Dimensions	59x41.5x230 mm
IP rating	IP65
LED	5W COB LED
Max. run time	1.5 ~ 7 Hour(s)
Max. run time spot	7 Hour(s)
Operating temperature	-10 ~ 40°C
Shock resistance	IK07

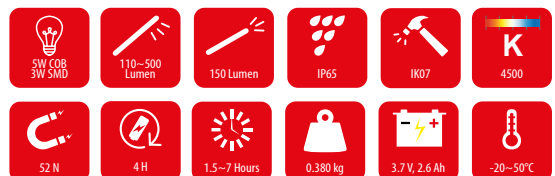

POWER TOOLS

AIR TOOLS

TOOL STORAGE

HAND TOOLS

WORKSHOP EQUIPMENT

SPECIALIST VEHICLE TOOLS

SIN-100.1075

3.7 V

Rechargeable COB floodlight 10W 1100 Lumen

- Rechargeable work lamp with COB LED technology
- COB LEDs provide 1100/550 Lumen
- Long life COB LEDs (life span 100.000 hours)
- Internally mounted magnets (40 N)
- 180° swivel base
- M8 hole to support with tripod
- Low power consumption, low heat emission
- Battery level indicator for easy monitoring
- Lamp use is not affected by cold temperatures
- Cordless design improves safety, convenience and flexibility
- 3.7 V 4.4 Ah Li-Ion battery provides 3 - 6 hours constant light output
- IP68 rated
- IK09 rated
- Robust, shock resistant ABS housing

XTREME
BRIGHTNESS
1100
LUMEN

Robust
floodlight



180°



POWERHAND®
POWER FOR PROFESSIONALS

Battery	3.7 V 4.4 Ah Li-Ion
Brightness	550 - 1100 Lumen
Charger	5 V, 1 A
Charging time	4.5 Hour(s)
Color temperature	5700 K
Dimensions	150x101x42 mm
IP rating	IP68
LED	10W COB
Material	ABS
Max. run time	6 Hour(s)
Operating temperature	-20 ~ 50°C
Shock resistance	IK09



X-SIN-100.0001-2

Charger 600 mA for SIN-100.0001



USIN-100.00192

Charger 1000 mA for SIN-100.0019 & SIN-100.0021



X-SIN-100.0001-1

Car charger for SIN-100.0001, SIN-100.0019, SIN-100.0021



SIN-100.0035-2

USB charger 500 mA for SIN-100.0035, SIN-100.1001 & SIN-100.1026



SIN-100.1026-2

Charger EU for USB lamps 5 V 1 A USB



SIN-100.1070-2

USB-charger EU 5 V 1 A USB



SIN-100.0035-1

Car charger USB for SIN-100.0035, SIN-100.1001 & SIN-100.1026



SIN-100.0035-6

Charge station for SIN-100.0035



SIN-100.0035-7

USB to micro-USB cable



POWER TOOLS

AIR TOOLS

TOOL STORAGE

HAND TOOLS

WORKSHOP EQUIPMENT

SPECIALIST VEHICLE TOOLS

SIN-100.1060-2

Charger EU
SIN-100.1060
1A USB



SIN-100.1060-1

Car charger for
SIN-100.1060 USB



SIN-100.1060-7

USB cable for
SIN-100.1060



SIN-100.1060-5

Battery 3.7 V 22 Ah
for SIN-100.1060
(18650)



SIN-100.1061

Flashlight adapter
250 Lumen
with Focus



SIN-100.1062

Worklamp slim
body 250 Lumen



SIN-100.1063

Flexible worklamp
200 Lumen



- Length: 450 mm
- Ø: 4.5 mm



SIN-100.1064

Flexible worklamp
3 Lumen



SIN-100.1065

Holder for work
lamp SIN-100.1060



SOLDERING

PPMT

Micro torch

- Compact, lightweight and easy-to-use
- Features an electronic ignition and flame adjustment
- Easily refillable with butane
- Lasts upto 2 hours between refills
- Ideal for a wide variety of applications
- Max. temperature 1300°C (torch), 500°C (soldering)



Power	120 W
Flame adjustment	12.7 ~ 63.5
Max. temperature (torch)	1300 °C
Max. temperature (soldering)	500 °C

PPSK

Soldering kit

- Easy start electronic ignition
- Converts to a torch
- Butane powered
- Portable
- Adjustable flame control
- Multiple tips for shrink wrapping, hot-air injection, cutting and soldering
- Quick refills
- Max. temperature 1300°C (torch), 500°C (soldering)



Power	120 W
Flame adjustment	12.7 ~ 63.5
Max. temperature (torch)	1300 °C
Max. temperature (soldering)	500 °C



POWER TOOLS

AIR TOOLS

TOOL STORAGE

HAND TOOLS

WORKSHOP EQUIPMENT

SPECIALIST VEHICLE TOOLS

PH-415-SET

Heavy-duty induction tool 1700 Watt

- Designed for quick, efficient and safe heating of metallic parts
- Even and stable heating without flames
- Sensors to ensure the part is not over-heated
- Safer working environment
- Low running cost
- Compact and lightweight
- Versatile heating elements
- Replacement coils available
- Ideal for a variety of workshop applications
- European manufacture



1700 WATT
800°C
4.5 KG



Heat parts to	> 800°C
Powered by	240 V mains
Contents	1x flexi coil 3 coil induction tool starter set

	Description	Size (mm)
PH-FLEXI800	Flexi coil	800
PH-IND415	Flexi coil	15
PH-IND419	Induction coils straight	19
PH-IND420	Induction coils straight	20
PH-IND423	Induction coils straight	23
PH-IND426	Induction coils straight	26
PH-IND432	Induction coils straight	32
PH-IND438	Induction coils straight	38
PH-IND445	Induction coils straight	45
PH-REMOVAL	Heat pad removal Ø 50	

PH-SPOT-KERA

Focusing ceramic coil for spot heating



PH-FLEXI-KERA

Ceramic flexi coil 800 mm



PH-430-SET

Induction tool set 3.5 Kw

- European manufacture
- Even and stable heating without flames
- Replacement coils available
- Water cooling 1.5 L
- 2 m cable

850°C
3500 WATT
12 KG

POWERHAND®
POWER FOR PROFESSIONALS



POWER TOOLS

AIR TOOLS

TOOL STORAGE

HAND TOOLS

WORKSHOP EQUIPMENT

SPECIALIST VEHICLE TOOLS

DU-RJDBT2

Pneumatic jack 2 bellows



Capacity	2000 kg at 8 bar
Relaxed height	146 mm
Full extension	350 mm
Max. air pressure	8 bar / 105 psi
Weight	16 kg
Limited warranty	2 year

DU-RJTBT2

Pneumatic jack 3 bellows



Capacity	2000 kg at 8 bar
Relaxed height	173 mm
Full extension	457 mm
Max. air pressure	8 bar / 105 psi
Weight	22 kg
Limited warranty	2 year

DU-RJTBT3

Pneumatic jack 3 bellows HD



Capacity	3000 kg at 8 bar
Relaxed height	185 mm
Full extension	477 mm
Max. air pressure	8 bar / 105 psi
Weight	27.5 kg
Limited warranty	2 year

DU-RJDBT2L

Pneumatic jack 2 bellows with handle



Capacity	2000 kg at 8 bar
Relaxed height	146 mm
Full extension	350 mm
Max. air pressure	8 bar / 105 psi
Weight	19.6 kg
Limited warranty	2 year

DU-RJTBT2L

Pneumatic jack 3 bellows with handle



Capacity	2000 kg at 8 bar
Relaxed height	173 mm
Full extension	457 mm
Max. air pressure	8 bar / 105 psi
Weight	25.5 kg
Limited warranty	2 year

DU-RJTBT3L

Pneumatic jack 3 bellows HD with handle



Capacity	3000 kg at 8 bar
Relaxed height	185 mm
Full extension	477 mm
Max. air pressure	8 bar / 105 psi
Weight	27.5 kg
Limited warranty	2 year

POWER TOOLS

AIR TOOLS

TOOL STORAGE

HAND TOOLS

WORKSHOP EQUIPMENT

SPECIALIST VEHICLE TOOLS

DU-RJBKT

Wall mount bracket

Wall mount bracket to keep your RakJak accessible and off the floor. Organize your shop with these handy wall mount brackets. Rugs and screws for masonry mounting included.



DU-RJPI

Alignment pad



DU-2212

Saddle pad high 42 mm



DU-2244

Saddle pad low 18 mm



DU-1492

Rubber pad/steel reinforced for saddle pad



DU-1493

Rubber pad for saddle pad



DU-RJPIV

Pad set 3pc



B-TJ30T

Jack 3T with quick lift (twin plunger)

- Folded chassis frame for added strength
- Heavy duty steel welded frame
- Steel wheels
- Minimum height 100 mm
- Maximum height 495 mm



Twin plunger system for rapid lift



B-TJLR15

Low Service Jack 1.5T speedlift function

Capacity 1500 Kg



POWER TOOLS

AIR TOOLS

TOOL STORAGE

HAND TOOLS

WORKSHOP EQUIPMENT

SPECIALIST VEHICLE TOOLS

GAJAK SELF LOADING DOLLIES
THE FACTOR CASTER SYSTEM

	Load rating	Tyre widths	Wheel sizes	Casters (mm)	Rollers	Weight
GJ5000 L/R	565 kg (2260 kg - 4 units)	up to 230 mm	13" - 16"	4 x 100	Twin, high impact PVC, self-lubricating	13.7kg
GJ6200 L/R	705 kg (2820 kg - 4 units)	up to 320 mm	13" - 19"	2 x 100 - 2 x 125	Twin, rust-resistant, plated steel	17.5kg
GJ4500 L/R	506 kg (2025 kg - 4 units)	up to 500 mm	13" - 19"	4 x 72.6	Four, rust-resistant, plated steel	19.5kg
GJ4100 L/R	464 kg (1392 kg - 3 units)	up to 177 mm	7.5" - 22"	4 x 75	Four, rust-resistant, plated steel	16.2kg





POWER TOOLS

AIR TOOLS

TOOL STORAGE

HAND TOOLS

WORKSHOP EQUIPMENT

SPECIALIST VEHICLE TOOLS



GJ5000

Vehicle mover 590 kg 2pc



Gojak was designed to improve vehicle movement and repositioning in workshops, showrooms and body shops but is also invaluable in car parks and to a multitude of rescue services. To overcome different axle widths, wheelbases, wheel sizes and tyre widths, every Gojak is self-loading. Gojak's are mechanical, therefore very quick and simple to use without the obvious hazard of leaking hydraulics. This system makes lifting and moving vehicles in any direction very quick and easy saving both time and money. With four models available an immense range of vehicles weighing up to 3.128 kg can be 'lifted & shifted'.



Load rating	590 kg (2360 kg 4 unit)
Mechanism	Double pawl bi-directional ratchet
Tyre widths	Fits tyres up to 230 mm wide
Wheel sizes	13" to 16"
Casters	Heavy duty: 4 x 100 mm
Rollers	Twin, high impact PVC, self lubricating
Unit weight	13.7 kg
Packed	2 units per box (1x right, 1x left)

GJ6200-SERIE

Vehicle mover 715 kg



Gojak was designed to improve vehicle movement and repositioning in workshops, showrooms and body shops but is also invaluable in car parks and to a multitude of rescue services. To overcome different axle widths, wheelbases, wheel sizes and tyre widths, every Gojak is self-loading. Gojak's are mechanical, therefore very quick and simple to use without the obvious hazard of leaking hydraulics. This system makes lifting and moving vehicles in any direction very quick and easy saving both time and money. With four models available an immense range of vehicles weighing up to 3.128 kg can be 'lifted & shifted'.



Load rating	715 kg (2860 kg 4 unit)
Mechanism	Double pawl bi-directional ratchet
Tyre widths	Fits tyres up to 320 mm wide
Wheel sizes	13" to 22"
Casters	Heavy duty: 2 x 100 mm, 2 x 125 mm
Rollers	Twin, high impact PVC, self lubricating
Unit weight	17.5 kg
Packed	1 units per box (right or left)



GJ4500

Vehicle mover 575 kg 

Gojak was designed to improve vehicle movement and repositioning in workshops, showrooms and body shops but is also invaluable in car parks and to a multitude of rescue services. To overcome different axle widths, wheelbases, wheel sizes and tyre widths, every Gojak is self-loading. Gojak's are mechanical, therefore very quick and simple to use without the obvious hazard of leaking hydraulics. This system makes lifting and moving vehicles in any direction very quick and easy saving both time and money. With four models available an immense range of vehicles weighing up to 3.128 kg can be 'lifted & shifted'.



GOJAK
THE FASTER CASTER SYSTEM™

Load rating	575 kg (2300 kg 4 unit)
Mechanism	Double pawl bi-directional ratchet
Tyre widths	Fits tyres up to 500 mm wide
Wheel sizes	13" to 22"
Casters	Heavy duty: 4 x 72.6 mm
Rollers	4, rust resistant, plated steel
Unit weight	19.5 kg
Packed	1 units per box (right hand model only)

GJ7016

Fahrzeugroller ideal mit Doppelrädern oder SUV's 

Gojak was designed to improve vehicle movement and repositioning in workshops, showrooms and body shops but is also invaluable in car parks and to a multitude of rescue services. To overcome different axle widths, wheelbases, wheel sizes and tyre widths, every Gojak is self-loading. Gojak's are mechanical, therefore very quick and simple to use without the obvious hazard of leaking hydraulics. This system makes lifting and moving vehicles in any direction very quick and easy saving both time and money. With four models available an immense range of vehicles weighing up to 3.128 kg can be 'lifted & shifted'.



GOJAK
THE FASTER CASTER SYSTEM™

Load rating	782 kg (3128 kg 4 unit)
Mechanism	Double pawl bi-directional ratchet
Tyre widths	Fits tyres up to 500 mm wide
Wheel sizes	13" to 22"
Casters	Heavy duty: 4 x 72.6 mm
Rollers	4, rust resistant, plated steel
Unit weight	24 kg
Packed	1 unit per box (right or left)

GJ4100-SERIE

Aviation mover



Load rating	465 kg (1860 kg 4 unit)
Mechanism	Linear ratchet
Tyre widths	Fits tyres up to 180 mm wide
Wheel sizes	7.5" to 22"
Casters	Heavy duty: 4 x 72.6 mm
Rollers	4, rust resistant, plated steel
Unit weight	18.5 kg
Packed	1 units per box (right or left)
Limited warranty	2 year



GJGOTOW

Tow truck mount bracket

The Gojak Truck Mount Bracket conveniently stores your Gojak until needed. The self-locking ratchet design insures your Gojaks stay in place and a convenient padlock bracket is provided to prevent theft. For use with models 5000, 4500 and 6200. Mounting hardware included.



GJGOBKT

Wall-mount bracket for Fahrzeugrollers

Convenient wall-mount bracket to keep your Gojak off the floor and accessible. Organize your shop with these handy brackets. Rugs and screws are included for masonry mounting. Fits all models.



GJ0465

Trolley for vehicle movers

Stores and moves 4 Gojaks in a convenient and orderly manner. Suitable for all Gojak models



GJ0465-6

Trolley 75 mm for vehicle movers

For trolley



GJ2006-B4N

75 mm Wheel for GJ4500 & GJ4100

For 4500 & 4100



GJ-COV5

Cover for Gojak

- For use on a towtruck
- Protection against all weather conditions



GJ2006-B56N

100 mm Wheel for GJ6200 & GJ5000

For 6200 & 5000



GJ2006-B6N

125 mm Wheel for GJ6200

For 6200



POWER TOOLS

AIR TOOLS

TOOL STORAGE

HAND TOOLS

WORKSHOP EQUIPMENT

SPECIALIST VEHICLE TOOLS

PH-MAT-4SET

XXL Rainbow mechanics mat set 4pc

- Supersized mechanics mats
- Dimensions: 990mm x 600mm x 30mm
- Dual colour, Black EVA foam top with coloured base for easy identification
- One of each colour, Red, Yellow, Blue and Green
- Cut-out handle



Height (mm)	30
Length (mm)	990
Width (mm)	600



B-M-SERIE

Mechanics mats

Made of in-layered EVA foam, closed cell material.



	Width (mm)	Length (mm)	Height (mm)	Type
B-M0460	270	460	30	Kneeling pad
B-M0480	320	480	30	Kneeling pad
B-M0900	380	900	30	Full-length mechanics mat
B-M1130	455	1130	30	XL Full-length mechanics mat

B-SC0001

Professional seat cover black

- Protect the seat from oil, grease and other dirt
- Universal fit - Patented design for rapid installation and removal
- Heavy-duty 4oz Nylon ensures a hard wearing, long lasting, high level of protection
- Airbag compatible - Velcro fastening sides allow for seat mounted side impact airbag operation
- Stays put - Strategically positioned elastic ensures the cover remains securely in place
- No buttons, zips or other damaging fastenings
- Anti-peel logo (also available plain)



	Description
B-SC0001	Professional seat cover - Black (BOXO branded)
SIN-150.0001	Professional seat cover - Blue (Plain)

JUMP STARTERS

PS-510E

Starter 12 V, 510 A



- Most used starting solution for all 12 V vehicles
- Audible reverse polarity warning
- On/Off isolator switches
- Spike protection
- Featuring high quality battery and charger
- Recyclable polyethylene casings
- Full in-house after-sales service
- Fully insulated cable clamps
- Welding grade cables
- 12 V car charger



Battery	20 Ah
Cable clamp	Fully insulated, 1000 A
Cable length	1.15 m
Cable width	25 mm ²
Charger	Automatic, 2 A
Cranking amps	510 A
Main switch	Yes
Peak amps	1200 A
Polarity warning	Yes
Safety fuse	No
Spike protection	Yes
Voltage	12 V
Weight	9.5 kg



PS-700EL

Starter 12 V, 700 A



- Most used starting solution for all 12 V vehicles
- Audible reverse polarity warning
- On/Off isolator switches
- Spike protection
- Featuring high quality battery and charger
- Recyclable polyethylene casings
- Full in-house after-sales service
- Fully insulated cable clamps
- Welding grade cables
- 12 V car charger



Battery	22 Ah
Cable clamp	Fully insulated, 1000 A
Cable length	1.15 m
Cable width	25 mm ²
Charger	Automatic, 2 A
Cranking amps	700 A
Main switch	Yes
Peak amps	1600 A
Polarity warning	Yes
Safety fuse	No
Spike protection	Yes
Voltage	12 V
Weight	9.5 kg



POWER TOOLS

AIR TOOLS

TOOL STORAGE

HAND TOOLS

WORKSHOP EQUIPMENT

SPECIALIST VEHICLE TOOLS

PS-800E

Starter 12 V, 800 A



- Most used starting solution for all 12 V vehicles
- Audible reverse polarity warning
- On/Off isolator switches
- Spike protection
- Featuring high quality battery and charger
- Recyclable polyethylene casings
- Full in-house after-sales service
- Fully insulated cable clamps
- Welding grade cables
- 12 V car charger



Battery	2x 20 Ah
Cable clamp	Fully insulated, 1000 A
Cable length	1.6 m
Cable width	35 mm ²
Charger	Automatic, 4 A
Cranking amps	800 A
Main switch	Yes
Peak amps	2400 A
Polarity warning	Yes
Safety fuse	No
Spike protection	Yes
Voltage	12 V
Weight	17.5 kg



PS-1224E

Starter 12 & 24 V, 1200 A & 700 A



- Most used starting solution for all 12 and 24 V vehicles
- Audible reverse polarity warning
- On/Off isolator switches
- Spike protection
- Featuring high quality battery and charger
- Recyclable polyethylene casings
- Full in-house after-sales service
- Fully insulated cable clamps
- Welding grade cables
- 12 V car charger



Ampere hour	22 Ah
Battery	2x 22 Ah
Cable clamp	Fully insulated, 1000 A
Cable length	1.6 m
Cable width	35 mm ²
Charger	Automatic, 4 A A
Cranking amps	1200 A
Main switch	Yes
Peak amps	3500/1600 A
Polarity warning	Yes
Safety fuse	No
Spike protection	Yes
Voltage	12 V + 24 V DC
Weight	17.9 kg



PS-1224HD-E

Starter 12 & 24 V, 1100 A



- Most used starting solution for all 12 and 24 V vehicles
- Audible reverse polarity warning
- On/Off isolator switches
- Spike protection
- Featuring high quality battery and charger
- Recyclable polyethylene casings
- Full in-house after-sales service
- Fully insulated cable clamps
- Welding grade cables
- 12 V car charger



Battery	2x 28 Ah
Cable clamp	Fully insulated, 1000 A
Cable length	1.6 m
Cable width	50 mm ²
Charger	Automatic, 8 A
Cranking Amps	1100 A/1100 A
Main switch	Yes
Peak amps	3500 A
Polarity warning	Yes
Safety fuse	500 A
Spike protection	Yes
Voltage	12 V + 24 V DC
Weight	26 kg



PS-24HD-E

Starter 24 V, 1100 A



- Most used starting solution for all 24 V vehicles
- Audible reverse polarity warning
- On/Off isolator switches
- Spike protection
- Featuring high quality battery and charger
- Recyclable polyethylene casings
- Full in-house after-sales service
- Fully insulated cable clamps
- Welding grade cables
- 12 V car charger



Battery	2x 28 Ah
Cable clamp	Fully insulated, 1000 A
Cable length	1.6 m
Cable width	50 mm ²
Charger	Automatic, 8 A
Cranking Amps	1100 A
Main switch	Yes
Peak amps	3500 A
Polarity warning	Yes
Safety fuse	500 A
Spike protection	Yes
Voltage	24 V DC
Weight	26 kg



PS-LI600

Powerstart 12 V Mini jump starter 300 A



Main switch	Yes
Polarity warning	Yes
Spike protection	Yes



PS-750LIL

Starter 12 V Li-Ion, 750 A

- Most used starting solution for all 12 V vehicles
 - Audible reverse polarity warning
 - On/Off isolator switches
 - Spike protection
 - Featuring high quality battery and charger
 - Recyclable polyethylene casings
 - Full in-house after-sales service
- Fully insulated cable clamps
 - Welding grade cables
 - 12 V car charger



Battery	8 Ah
Cable clamp	Fully insulated, 1000 A
Cable length	1.75 m
Cable width	25 mm ²
Charger	Automatic, 2 A
Cranking amps	750 A
Main switch	Yes
Peak amps	1000 A
Polarity warning	Yes
Safety fuse	No
Spike protection	Yes
Voltage	12 V
Weight	4.75 kg



PS-775LI

Starter 12 V, 775 A

Unique LiFePO4 starting solution for all 12 V vehicles

- USB output: Dual 5 V, 2.1 A, 1.0 A
- DC output: 12 V, 8 A
- Cranking amps: 775 A (peak 1200 A)
- Operating temperature -20 ~ 60°C
- On/Off switch
- Featuring high quality battery and charger
- Small and light unit
- Full in-house after-sales service
- Fully insulated cable clamps
- Welding grade cables (16 mm²)
- 12 V car charger

Built in BMS protection:

- Short circuit
- Reverse polarity warning
- Reverse charging
- Over (dis)charge
- Over current
- Over temperature
- Spike protection



Battery	8 Ah
Battery type	Li-ion
Cable clamp	Fully insulated, 1000 A
Cable length	0.70 m
Cable width	16 mm ²
Charger	Automatic, 2 A
Cranking amps	775 CCA
Main switch	Yes
Peak amps	1200 A
Polarity warning	Yes
Spike protection	Yes
Voltage	12 V
Gewicht	3.3 kg



12 V, 8 Ah

PS-TROLLEY

Power-Start trolley



PS-LI600-9

Cigaret lighter connection female für PS-LI600

POWER Cigaret lighter connection female für PS-LI600



PS-7601-0004

Car charger lead for PS-510E & PS-700E

POWER



PS-7454-0005

Clamps red

Heavy duty clamps with wide opening, featuring solid copper jaws and high quality braid to ensure best possible flow of current. Fully insulated to avoid short circuiting, strong spring for absolute contact.

POWER



PS-7454-0006

Clamps black

Heavy duty clamps with wide opening, featuring solid copper jaws and high quality braid to ensure best possible flow of current. Fully insulated to avoid short circuiting, strong spring for absolute contact.

POWER



PS-K703K710

Car charger lead for PS-800E & PS-1224E

POWER



PS-OBDII

OBI II Cable for 12 V

POWER



PS-7450-0004

Key for PS-510E & PS-700E



PS-7450-0006

Key for PS-1224HD-E & PS-24HD-E



PS-7450-0008

Switch for PS-800E & PS-1224E

Specially designed heavy duty, re-enforced ‘series/parallel’, switch capable of transferring high currents. Unique switch cover ensures correct charging routine, guaranteeing a safe charge procedure every time.



PS-7453-0008

Fuse 500 A

The internal fuse protects the battery against short circuits and overloads. Heavy duty units only.



PS-7450-0001

Key + switch for PS-510E & PS-700E



For ps-510E & PS-700E

PS-7450-0002

Key + switch for HD-serie



For HD-serie

POWER TOOLS

AIR TOOLS

TOOL STORAGE

HAND TOOLS

WORKSHOP EQUIPMENT

SPECIALIST VEHICLE TOOLS

PS-7700-0040

Charger 12 V for PS-510E & PS-700E



Output	12 V DC, 2 Amp
Input	230-240 V ~ 50 Hz
Charger	Automatic, 2 A

PS-7700-0019

Charger 12 V for PS-800E & PS-1224E



Output	12 V DC, 4 Amp
Input	100-240 V ~ 50/60 Hz
Charger	Automatic, 4 A

PS-7700-0021

Charger 12 V for PS-1224HD-E & PS-24HD-E



Output	12 V DC, 8 Amp
Input	100-240 V ~ 50/60 Hz
Charger	Automatic, 8 A

PS-JL35-SERIE

Jump leads

High quality, professional jump leads available in two lengths, with or without 12 V/24 V surge protection.



	Length (mm)	Surge protection
PS-JL353	3000	No
PS-JL355	5000	No

PS-JL353SP / 355SP

Jump lead with surge protection

High quality, professional jump leads available in two lengths, with or without 12 V/24 V surge protection.



	Length (mm)	Surge protection
PS-JL353SP	3000	Yes
PS-JL355SP	5000	Yes

PS-JLSP

In-line 12 V/24 V jump lead surge protector

Protects the onboard electronics from voltage spikes during jump starts.

- Easy-fit, no cutting or connecting of cables
- Both vehicles protected during jump starts
- LEDs indicate correct polarity and low voltage at donor battery
- Unique patented design



Jump leads	10 ~ 14.5 mm
Suitable for	all 12 V & 24 V systems
Surge protection	yes

PS-SP1224

Surge protector 12/24 V

Protects the vehicle electronics from voltage spikes and surges on 12 V and 24 V

- Clips across battery terminals
- Heavy-duty, fully insulated 30A Nickel plated clamps
- Heavy gauge cable
- LED indicator



VVD006

Battery service kit 7pc

- 8, 10 mm
- L 10 mm

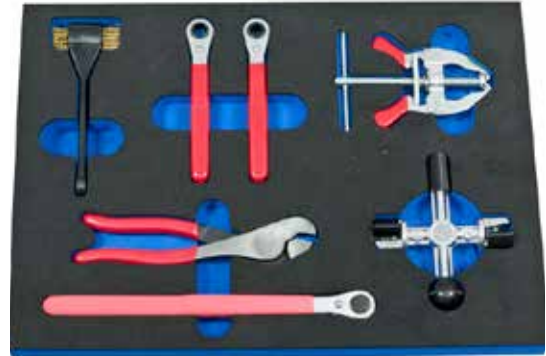

BT55

Battery tester 6/12/24 V

- Accurate, easy-to-read LCD screen
- Checks the battery, alternator systems
- Two LED indicators
- Overvoltage Protection
- Reverse Polarity Protection



BT175

Battery tester 12 V

- Accurate, easy-to-read LED screen
- Checks the battery, starting and charging systems
- Four LED indicators
- 12 volt batteries, up to 1200 cold cranking amps
- Battery state of charge
- Battery cranking ability
- Charging system output
- Starter motor draw
- SAE, DIN, IEC, EN



SBT

Smart battery tester 6 ~ 12 V, test charge 12 ~ 24 V

- Integrated printer Testbatteries 6 ~ 12 V
- Test charge + Start systems
- EFB, VRLA, GEL, AGM + Start & Stop system
- SAE, DIN, IEC, EN, JIS
- 40-2000 CCA
- E, FR, DE, ES, IT, PT, NL

START & STOP SYSTEM!



Accessories
SBT - Paper - 2pc



POWER TOOLS

AIR TOOLS

TOOL STORAGE

HAND TOOLS

WORKSHOP EQUIPMENT

SPECIALIST VEHICLE TOOLS



- 1 ANALYZE
- 2 RECOVER
- 3 SOFT START
- 4 BULK MODE
- 5 ABSORPTION
- 6 MONITORING
- 7 FLOAT MODE
- 8 MAINTAIN



**8 STEP
AUTOMATIC**

**MULTI-STAGE
CHARGING**

This unique charger uses Microprocessor controlled technology with multi-stage charging for added precision, safety and battery life.

SPI1

Automatic battery charger 1 Amp

Fully automatic 1 Amp battery charger/maintainer. Keeps stored batteries charged. Charges AGM, standard, gel cell, calcium, start/stop batteries.

- 6 ~ 12 V
- 8 step automatic microprocessor controlled Multi-stage charging for added precision, safety and battery life
- Designed to charge 6 V up to 12 Ah, 12 V up to 32 Ah
- -20° to 50°C
- IP54 - Spark proof - Thermal runaway
- Float-mode monitoring
Automatically maintains optimum battery charge
- Reverse hook-up protection
Helps protect battery and charger from damage
- Startup threshold from 0.2 V

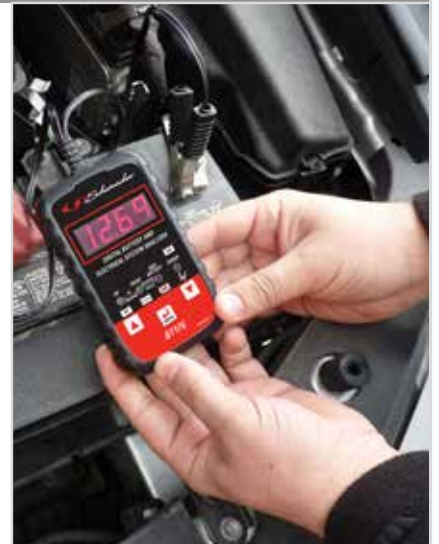

SPI2

Automatic battery charger 2 Amp

Fully automatic 2 Amp battery charger/maintainer. Keeps stored batteries charged. Charges AGM, standard, gel, calcium and Start/Stop batteries.

- 6 ~ 12 V
- 8 step automatic microprocessor controlled Multi-stage charging for added precision, safety and battery life
- Designed to charge 6 V up to 12 Ah, 12 V 12 ~ 46 Ah
- -20° to 50°C
- IP54 - Spark proof - Thermal runaway
- Float-mode monitoring
Automatically maintains optimum battery charge
- Reverse hook-up protection
Helps protect battery and charger from damage
- Startup threshold from 0.2 V



SPI3

Automatic battery charger 3 Amp

Fully automatic 3 Amp battery charger/maintainer. Keeps stored batteries charged. Charges AGM, standard, gel, calcium and Start/Stop batteries.

- 12 V
- 8 step automatic microprocessor controlled Multi-stage charging for added precision, safety and battery life Designed to charge 12 V 6 ~ 58 Ah
- -20°C to 50°C
- IP64 - Spark proof - Thermal runaway
- Lithium LiFePo4
- Float-mode monitoring Automatically maintains optimum battery charge
- Reverse hook-up protection Helps protect battery and charger from damage
- Language button Press the button to select English, German or French
- Startup threshold from 0.2 V



- 1 ANALYZE
- 2 RECOVER
- 3 SOFT START
- 4 BULK MODE
- 5 ABSORPTION
- 6 MONITORING
- 7 FLOAT MODE
- 8 MAINTAIN

SPI6

Automatic battery charger 6 Amp

Fully automatic 6 Amp battery charger/maintainer. Keeps stored batteries charged. Charges AGM, standard, gel, calcium and Start/Stop batteries.

- 12 V
- 8 step automatic microprocessor controlled multi-stage charging for added precision, safety and battery life designed to charge 12 V 6 ~ 130 Ah
- -20° to 50°C
- IP20 - Spark proof - Thermal runaway
- Float-mode monitoring automatically maintains optimum battery charge
- Reverse hook-up protection helps protect battery and charger from damage
- Language button press the button to select English, German or French
- Startup threshold from 0.2 V

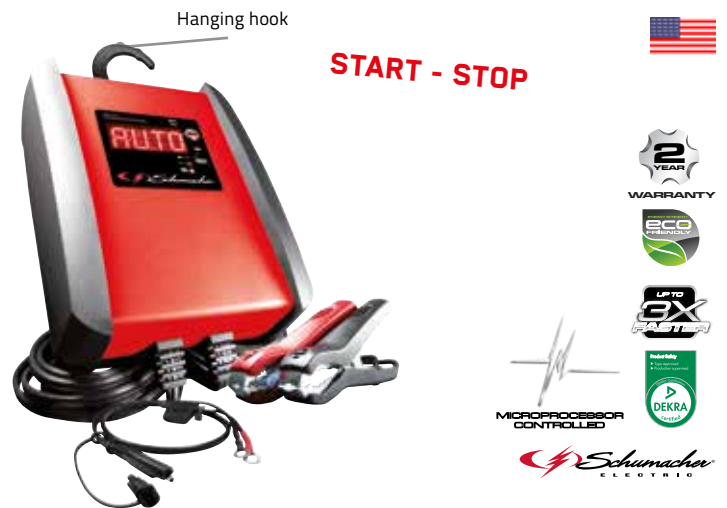

- 1 ANALYZE
- 2 RECOVER
- 3 SOFT START
- 4 BULK MODE
- 5 ABSORPTION
- 6 MONITORING
- 7 FLOAT MODE
- 8 MAINTAIN

SPI10

Automatic battery charger 10 Amp

Fully automatic 10 Amp battery charger/maintainer. Keeps stored batteries charged. Charges AGM, standard, gel cell, calcium and Start/Stop batteries.

- 8 step automatic microprocessor controlled Multi-stage charging for added precision, safety and battery life
- Designed to charge 12 V 10 ~ 200 Ah
- -20° to 50°C
- IP20 - Spark proof - Thermal runaway
- Float-mode monitoring Automatically maintains optimum battery charge
- Reverse hook-up protection Helps protect battery and charger from damage
- Language button Press the button to select English, German or French
- Startup threshold from 0.2 V



- 1 ANALYZE
- 2 RECOVER
- 3 SOFT START
- 4 BULK MODE
- 5 ABSORPTION
- 6 MONITORING
- 7 FLOAT MODE
- 8 MAINTAIN

POWER TOOLS

AIR TOOLS

TOOL STORAGE

HAND TOOLS

WORKSHOP EQUIPMENT

SPECIALIST VEHICLE TOOLS

SPI15

Automatic battery charger 15 Amp

Fully automatic 15 Amp battery charger/maintainer
Keeps stored batteries charged. Charges AGM, standard, gel, calcium and Start/Stop batteries.

- 8 step automatic microprocessor controlled Multi-stage charging for added precision, safety and battery life
- Designed to charge 12 V 10 ~ 230 Ah
- -20°C to 50°C
- IP20 - Spark proof - Thermal runaway
- Float-mode monitoring automatically maintains optimum battery charge
- Reverse hook-up protection Helps protect battery and charger from damage Language button
- Press the button to select English, German or French
- Startup threshold from 0.2 V



START - STOP



SPI1024V

Automatic battery charger 24 V, 10 Amp

Fully automatic 10 Amp battery charger/maintainer
Keeps stored batteries charged. Charges AGM, Standard, Gel, Calcium, and Start/Stop batteries.

- 8 step automatic microprocessor controlled Multi-stage charging for added precision, safety and battery life
- Designed to charge 24 V 20 ~ 200 Ah
- -20°C to 50°C
- IP20 - Spark proof - Thermal runaway
- Float-mode monitoring automatically maintains optimum battery charge
- Reverse hook-up protection helps protect battery and charger from damage
- Language and battery type button
- Press the button to select English, German or French
- Startup threshold from 0.2 V



MULTI-STAGE CHARGING

- | | | |
|--------------|--|--------------|
| ① ANALYZE | | ⑤ ABSORPTION |
| ② RECOVER | | ⑥ MONITORING |
| ③ SOFT START | | ⑦ FLOAT MODE |
| ④ BULK MODE | | ⑧ MAINTAIN |

SCI90

Microprocessor controlled battery charger/power supply
3 Ah, 5 ah, 20 ah, 150 Ah

- Microprocessor controlled multi-stage charging for added precision, safety and battery life
- Thermal runaway protection monitors charge process to prevent battery from overheating
- Auto voltage detection automatically detects 6 or 12 volt batteries
- Desulfation mode a special mode of operation designed for sulfated batteries
- Float monitoring automatically maintains optimum battery charge
- Reverse hook protection charger will not operate if clamps are reversed on battery terminal
- Short circuit protection, spark proof
- Digital display
- Charges all battery types standard, lead-acid, calcium, AGM, start-stop & gel cell batteries



STARTER



INC100

Microprocessor controlled 100 Amp battery charger/power supply 12 V



Battery charger features

- Variable charge rates (4/20/70 Amp)
- Digital volts and amps display
- Manual mode with digital timer Unit features

Unit features

- Microprocessor controlled operation
- Multiple output cable selection
- 3 m - 4 gauge
- 4 m - 2 gauge
- 5 m - 2 gauge
- Exchangeable power cord
- Heavy-duty clamps
- Large carry handle
- Adjustable mounting brackets
- Dual temperature controlled cooling fans
- Durable aluminum case Power supply features

Power supply features

- Constant voltage output (13.0 to 14.8 V DC)
- Output current up to 100 Amps for 3 minutes
- 70 Amps continuous output current Specifications

Specifications

- Output: 12 V, 70 A
- Case dimensions: 324x108x235 mm
- Weight: 6.4 kg



OBD-L

Memory saver detector 12 V

Memory saver detector Attach between a portable power unit and a vehicle's On-BoardData (OBDII) diagnostic port, to maintain power to the vehicle's on-board microprocessor-controlled devices when the vehicle's battery is disconnected for service or replacement.

- Fully automatic
- Standard fuse protected auxiliary input plug
- Easy to follow 3-step instructions printed on unit
- Auto detection Will detect automatically if the vehicle's electronics will allow this device to save on-board data
- LED indication Two yellow LEDs at each end indicate that the OBDII port connection and the connection to the portable power unit are sound. Red LED (Do Not Proceed) or Green LED (Proceed) indicate whether it is safe to remove or service the vehicle's battery without fear of losing data stored in the vehicle's microprocessor controlled devices.
- Works on all vehicles equipped with a standard on-board data (OBDII) port



POWER TOOLS

AIR TOOLS

TOOL STORAGE

HAND TOOLS

WORKSHOP EQUIPMENT

SPECIALIST VEHICLE TOOLS

U-SIN-300.0046

Magnetic tray



U-SIN-300.0047

Pick up tool (Magnetic)

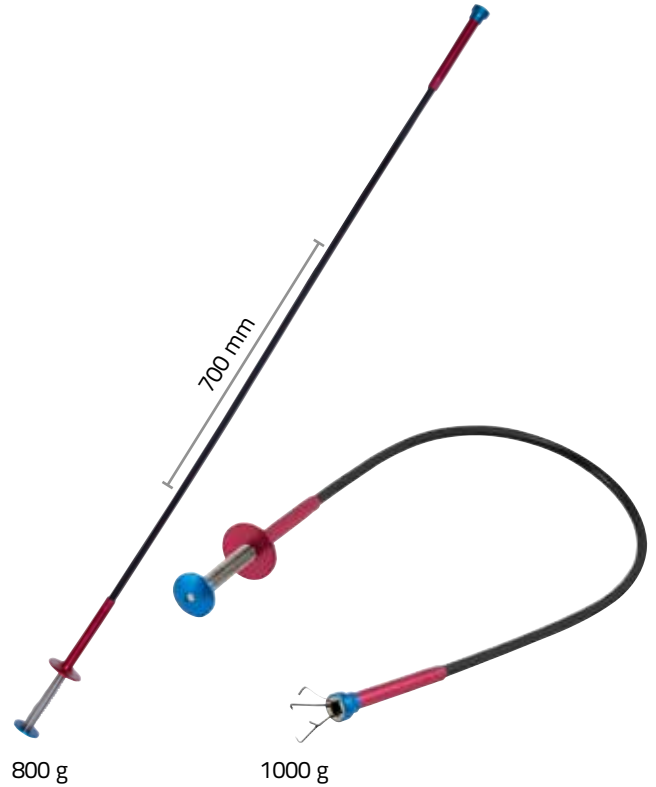

U-SIN-300.0045

Magnetic tool set 2pc



U-SIN-406.0005

Hydraulic nut splitter 7 ~ 22 mm



- Suitable for nuts: 7 ~ 22 mm



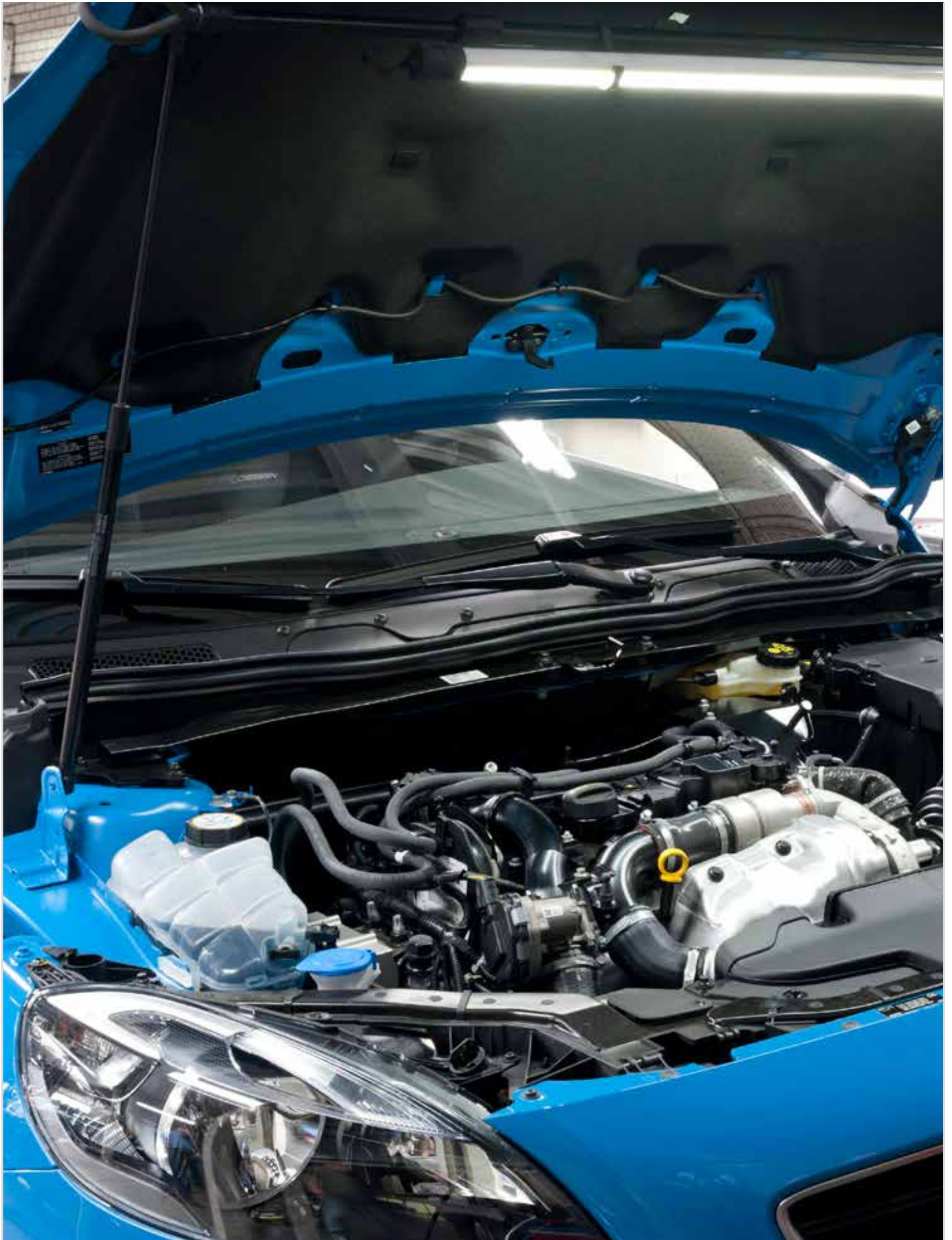

POWER TOOLS

AIR TOOLS

TOOL STORAGE

HAND TOOLS

WORKSHOP EQUIPMENT

SPECIALIST VEHICLE TOOLS

SPECIALIST VEHICLE TOOLS





Our Boxo Auto range has been added to further for this edition, and offers a variety of specialist products with specific vehicle applications from windscreen removal to valve spring compressor sets and ignition coil pullers for VW/Audi to vacuum and pressure testers. Many are supplied in high quality EVA foam inlays along with the Power Case for easy identification and storage.



Our Powerhand brand continues to feature across the auto tools range.



Tyre Seals repair kits have been specifically designed to enable puncture repairs whilst the wheel remains on the vehicle. With both string and mushroom type plug repair kits in the programme, Tyre Seals is a puncture repair system that is suitable for both passenger cars and trucks. Tyre Seals have a number of standard approvals but as on vehicle puncture repair regulations vary in different countries the user should always check the local regulations before use.















This ingenious air operated tool opens up flexible CV boots effortlessly and evenly allowing simple insertion onto the shaft without the need to dismantle the joint. It totally eliminates the need for lubrication and the struggling involved with the manual cone method, saving you both time and money! The accompanying range of high quality, flexible neoprene rubber boots with resistance to ozone, oil, water, grit, abrasion and temperature extremes (-40° to 115°C) have been designed specifically for use with the Bootgun.



Power Probe is dedicated to the creation of innovative, easy to use diagnostic equipment for the automotive industry. Specifically focuses on auto electrics, the range meets the increasingly complex needs of today's automotive technician. Every Power Probe product is quality tested when it leaves the factory to ensure that it meets the highest standards of excellence and reliability.

SYMBOL GUIDE







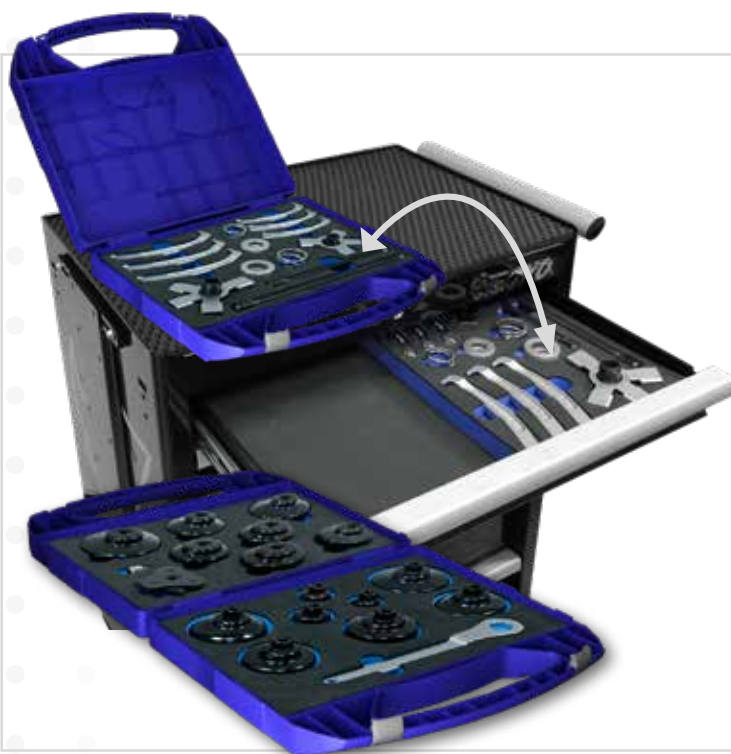

	Diesel vehicles		Chrome vanadium		3/8" Drive
	Petrol vehicles		Chrome molybdenum		Petrol vehicle applications
	TX male		Spline		Diesel vehicle applications
	6-point		1/2" Drive		Diameter

SUB-SECTIONS

246	BODYWORK AND INTERIOR TOOLS
251	WHEEL AND TYRE TOOLS
258	STEERING AND SUSPENSION TOOLS
259	ENGINE TOOLS
260	STEERING AND SUSPENSION TOOLS
267	BRAKE TOOLS
272	ENGINE TOOLS
279	PULLERS
282	OIL AND FUEL EQUIPMENT
287	TORQUE MULTIPLIERS
288	DIAGNOSTIC AND TESTING TOOLS

THE POWER CASE



	Dimensions	Drawer Capacity
Power Case A 	80 x 293 x 287	 Drawer 75H
Power Case B 	81 x 411 x 399	 Drawer 75H
Power Case C 	104 x 411 x 399	 Drawer 150H
Power Case D 	126 x 411 x 399	 Drawer 150H OR  Drawer 75H

THE POWER CASE



POWER TOOLS

AIR TOOLS

TOOL STORAGE

HAND TOOLS

WORKSHOP EQUIPMENT

SPECIALIST VEHICLE TOOLS

U-SIN-300.0035

Door hinge remover & installer 9pc



Contents:

- TX: T30, T40, T45, T50
- XZN: M8, M10, M12



VD478

Bodywork Dent Puller



- Pulls out dents without the need to remove interior panels
- Replaceable self-tapping screw
- Sliding weight: 0.82 kg



HU-HU44016

Air vacuum dent puller



Sliding hammer to ease dent without damaging the paint surface.

- Air inlet: 1/4"
- Suction pads: 75 mm, 100 mm, 125 mm, hook
- Sliding weight: 1.22 kg
- Weight: 4.7 kg

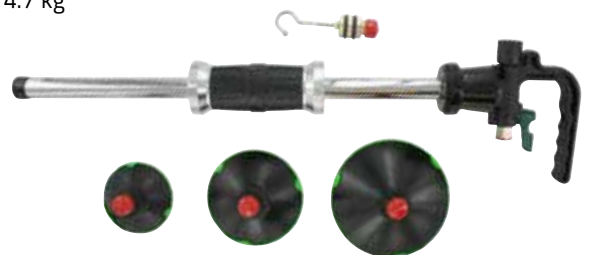

Air consumption	Steel & plastic l/m
Material	Steel and plastic

HU-HU14005

Cordless hot stapler kit



- Avoid replacing expensive parts if not needed
- Precision-engineered tool that helps you make solid, permanent repairs of breaks, cracks and tears in rigid or flexible plastic parts
- Adjustable head for multiple angles
- LED Light
- Low battery indicator lights
- Ideal for automotive (bumpers, broken locator pins, door panel clips etc) but also for power sports, hobby and industrial applications
- Staple types: 100 of each - V-shaped 0.6 mm, U-shaped 0.6 mm and U-shaped 0.8 mm
- Charger: 110 ~ 240 V



POWER TOOLS

AIR TOOLS

HU-HU14002

Coating thickness tester kit



- Dual technology features an automatic selection of magnetic induction or Eddy current measurement techniques. Ideal for non-magnetic coatings (e.g. paint, zinc) on steel, insulating coatings (e.g. paint) on non-ferrous metals, non-ferrous metal coatings on insulating substrates.
- High alarm and low alarm for all working mode
- Battery indicator
- USB interface for PC software (Windows 98/2000/XP/Vista)
- Sensor probe F N
- Kit includes two AAA batteries, USB cable, CD, calibration iron, calibration aluminum and precision standard



TOOL STORAGE

HAND TOOLS

VVD012

Trim pin removal set 5pc



- Ergonomic dual-colour handle
- Ideal for use on a variety of vehicles to allow removal of clips on the cowl of door panel
- Blade material: heat treated stainless steel

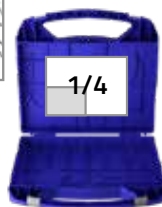
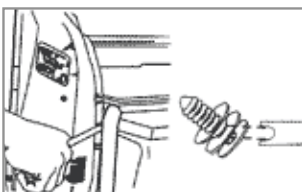

Material Heat treated stainless steel

WORKSHOP EQUIPMENT

SPECIALIST VEHICLE TOOLS

VD416

Scraper set 4pc



- Ideal for removing trim, badges and decals from bodywork
- Also suitable for removing residue from alloy wheels
- Polypropylene edges will not scratch or mark paint or panel work and can be re-sharpened with a file when required

Contents:

19 mm, 22 mm, 25 mm, 38 mm



VD013-13

Remover set 5pc



- For plastic upholstery fasteners
- Place tool under edge of door panel and insert into fastener as fast as possible, and then simply pry up
- Large support area to protect clips and pad

Contents:

- 2x Pull-type
- General
- Narrow
- Upholstery clip remover



VVD002

Radio removal tool set 20pc



- For releasing locking mechanisms on car radios and navigation systems
- Suitable for a variety of vehicle manufacturers including Audi, BMW, Fiat, Ford, Mercedes, VW and Porsche



VVD020

Air bag removal tool set 7pc



- Especially designed for the removal of air bags
- 7 tools for specific applications
- Prevents damage to expensive SRS components

Applications:

- Tool 1: VW GOLF 4 (98 ~ 04), VW PASSAT (97) BORA (91)
- Tool 2: VW PASSAT, JETTA, GOLF & BEETLE (99 ~ 04)
- Tool 3: VW PASSAT B5, POLO, LUPO, AUDI A4, A6, SKODA SUPERB.
- Tool 4: VW GOLF 4, NEW BEETLE, SEAT, SKODA FABIA, OCTAVIA (91)
- Tool 5: VW PASSAT (00)
- Tool 6: 1/4" Bit Socket - T30 - AUDI, OPEL, RENAULT, VW
- Tool 7: 1/4" Bit Socket - T25 - BMW



SIN-300.0021

Washer jet tool



- Double ended tool for redirecting and cleaning out blocked washer jets.



VD423

Window scraper 100 mm



Replacement blades VD424 30pc

Length 100 mm

VVD014

Windscreen removal set 7pc



- Suitable for all glue windscreens and most side and rear windows
- Cutting wire for fast and easy cutting of nearly all adhesive beads
- Wire starter tool with large T-Handle to pierce the wire through the bead
- Self-closing safety handles to hold the wire firmly

Contents:

- Round cutting wire
- 2x Wire grip handles
- Standard cold knife
- T-Handle
- Wire starter tool
- Moulding release tool
- Door upholstery remover

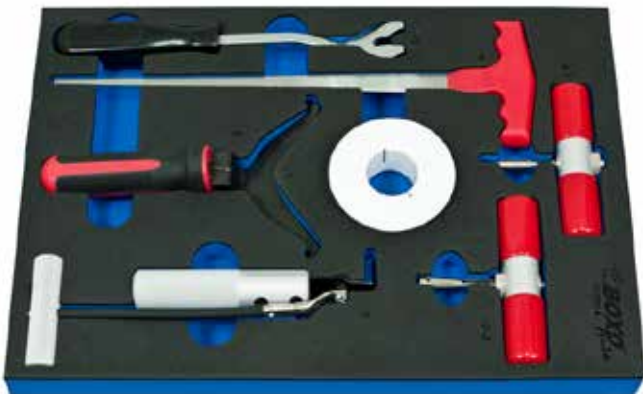

VD424

Razor Scraper Blade (30pc) for VD423 30pc



SIN-300.0040

3/8"

3/8" Wiper arm/battery pole remover



- Uses 3/8" ratchet
- Specially designed rear wiper arms with integrated washer jets



POWER TOOLS

AIR TOOLS

TOOL STORAGE

HAND TOOLS

WORKSHOP EQUIPMENT

SPECIALIST VEHICLE TOOLS

HU-HU14001

Ultrasonic leak detector



- Transmits a specific frequency of ultrasonic sound waves that do not travel through glass or metal
- Quickly find air and water leaks on a vehicle
- Audible and visual indication of leaks
- Easy to use (no driving required)
- Set includes a transmitter and receiver
- 9 V, 12 V, 24 V operation
- Supplied in a canvas carry bag



HU-HU33003

2 in 1 HVAC ultrasonic leak detector



- High sensitivity
- Ideal for A/C leaks
- Ultra visible LED bar
- Volume switch
- Supplied in a canvas carry bag

Can be used for inspecting and checking a variety of applications including,

- Vacuum and compressed air leaks
- Electrical systems
- LPG system
- Tyre leaks

Contents:

- Receiver for audio feedback (LED indicator)
- Ultrasound transmitter (for container cracks, door seals, any air or water leaks within the vehicle)
- 2 anodized probes: an air and a contact probe
- Headphones and 9 V batteries



WHEEL AND TYRE TOOLS

U-MET-2460 1/2" SIN-170.0010 1/2"

Nut set 6pc - MET-2460



Sockets:

- 1/2 Impact Socket sizes 17, 19, 21 mm (SAE AF) 11/16, 3/4, 13/16
- 1/2 Impact Socket deep sizes 17, 19, 21 mm (SAE AF) 11/16, 3/4, 13/16



1/2" Alloy wheel nut socket set 3pc



- Teflon coating prevents damage to alloys
- Colour coded sockets for speedy size selection
- Sizes 17, 19, 21 mm



SIN-170.00-SERIE 1/2" U-SIN-170.0020 1/2"

1/2" Alloy wheel nut sockets



	Size (mm)
SIN-170.0017	17
SIN-170.0019	19
SIN-170.0021	21
SIN-170.0022	22

1/2" Alloy wheel nut socket set, with magnet 3pc



- The SIN-170.0020 features an internal spring loaded magnet, which automatically retains the nut
- Teflon coating prevents damage to alloys
- Colour coded sockets for speedy size selection
- Sizes 17, 19, 21 mm
- Magnetic



TEX4040-SERIE 1/2" SKIN406A-SERIE 1/2"

1/2" Torque extension bars



	TORQUE	Color
TEX4040-090	90 Nm	Green
TEX4040-100	100 Nm	Black
TEX4040-110	110 Nm	Yellow
TEX4040-120	120 Nm	Red
TEX4040-135	135 Nm	Blue
TEX4040-150	150 Nm	Orange
TEX4040-160	160 Nm	Gray
TEX4040-175	175 Nm	Brown
TEX4040-190	190 Nm	White
TEX4040-200	200 Nm	Light blue



1/2" Alloy wheel impact sockets - 6 Pt



	Size (mm)
SKIN406A-15	15
SKIN406A-17	17
SKIN406A-19	19
SKIN406A-21	21
SKIN406A-22	22



POWER TOOLS
AIR TOOLS
TOOL STORAGE
HAND TOOLS
WORKSHOP EQUIPMENT
SPECIALIST VEHICLE TOOLS

VVA001

FWD front wheel bearing tool 24pc



- No need to remove the knuckle and strut assembly
- No need to re-align as the spindle is not removed
- Fits on most FWD cars
- 1 of each, nut, screw and washer
- Sizes 38, 50, 55, 59, 63.5, 66.5, 70.5, 71, 73, 73.5, 74.5, 76, 77.5, 81.5, 83.5, 86, 88.5, 91, 102 mm



X-SIN-170.0120

Wheel hanger sleeve set 5pc



- Contents:**
- M12xP1.5
 - M12xP1.25F
 - M14xP1.25
 - M14xP1.5
 - M16xP1.5



VVA002

Adjustable wheel bearing lock nut wrench set for 6- and 8-sided wheel nuts

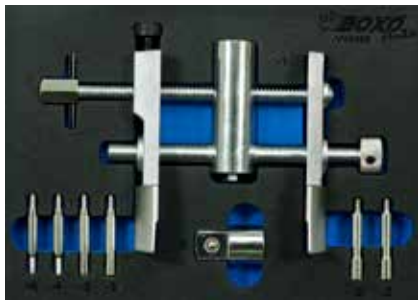

VVS005

Bearing race & seal driver kit 8pc



- Quickly & easily inserts wheel bearing races & seals without damage to race & axle housing
- 7 disc size fit most standard wheel bearing
- The reverse side of disc can be used to drive seals evenly



VVA005

1/2" Bolt extractor set 6pc



- Contents:**
- 19 mm
 - 21 mm
 - 22 mm
 - 24 mm
 - 25.4 mm (1")

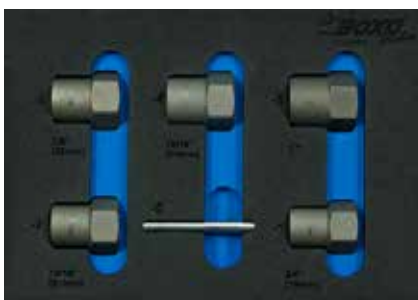

VVG002

1/2" Bolt extractor set 14pc



- Contents:**
- 10 mm
 - 11 mm
 - 12 mm
 - 13 mm
 - 14 mm
 - 16 mm
 - 17 mm
 - 18 mm
 - 19 mm
 - 21 mm
 - 22 mm
 - 24 mm
 - 27 mm

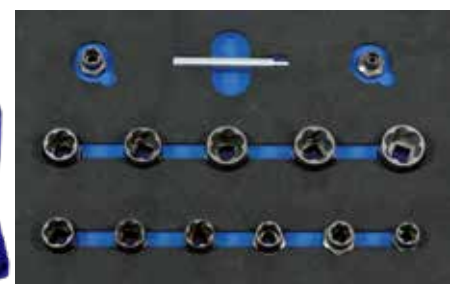

 **BOXO**[®]
tools for life

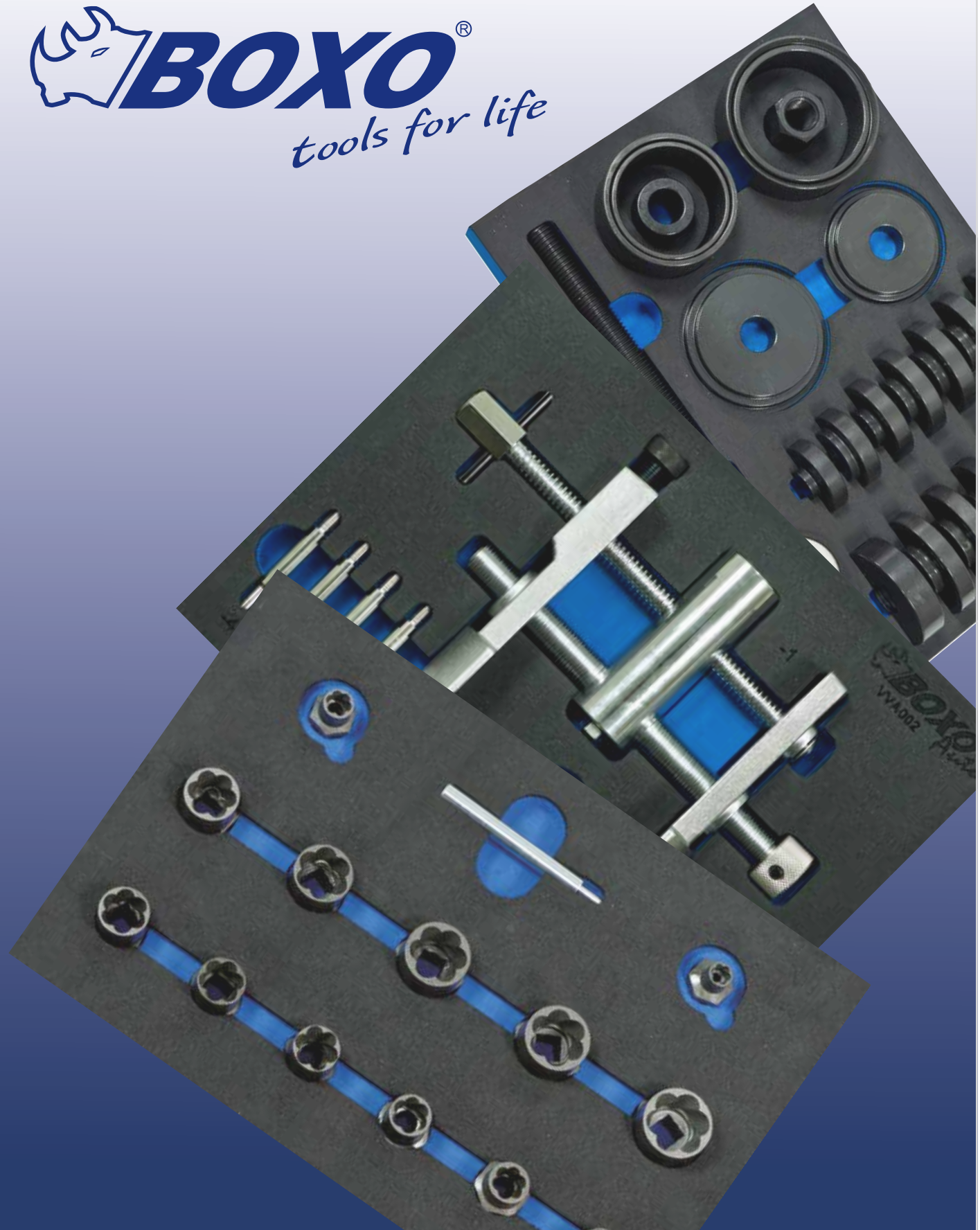

POWER TOOLS

AIR TOOLS

TOOL STORAGE

HAND TOOLS

WORKSHOP EQUIPMENT

SPECIALIST VEHICLE TOOLS

PU-115990

Tyre repair set for passenger cars

The vulcanising repair is made with a blend of butyl rubber, elastomers, chemically blended vulcanising agents, including silicon, vulcanising agents and accelerators. The manufacturing process combines this rubber compound with high tensile strength continuous filament specially processed nylon fibres. Tyre Seals strings are made up of 48 strands of tyre cord fibres that are impregnated under high pressure and heat with the specially developed rubber compound to fill each individual strand. This process prevents the passage of air through fibres, which could result in tyre repair failure. Tyre Seals strings are subject to intense heat to bond the special rubber formula to the nylon tyre cord, making an unusually strong and reliable tyre repair. Tyre Seals strings are a heavy-duty sealant that instantly seals punctures of up to 3/8 of an inch in diameter (9.5 mm). Tyre Seals tyre repair is the repair of the future. It not only seals the inside of the hole to prevent air leaking out of the tyre, it also seals the inner liner of the tyre from steel belted portion of the tyre. The Tyre Seals tyre repair seals out road moisture that would normally invade the steel belts of the tyre through the puncture opening from the outside of the tyre.

Contents

- 1 Open eye needle (short)
- 1 Rasp
- 1 Lube/Cleaner
- 1 Knife
- 60 Repairs (100 mm)



PU-115991

Tyre repair set for trucks

The vulcanising repair is made with a blend of butyl rubber, elastomers, chemically blended vulcanising agents, including silicon, vulcanising agents and accelerators. The manufacturing process combines this rubber compound with high tensile strength continuous filament specially processed nylon fibres. Tyre Seals strings are made up of 48 strands of tyre cord fibres that are impregnated under high pressure and heat with the specially developed rubber compound to fill each individual strand. This process prevents the passage of air through fibres, which could result in tyre repair failure. Tyre Seals strings are subject to intense heat to bond the special rubber formula to the nylon tyre cord, making an unusually strong and reliable tyre repair. Tyre Seals strings are a heavy-duty sealant that instantly seals punctures of up to 3/8 of an inch in diameter (9.5 mm). Tyre Seals tyre repair is the repair of the future. It not only seals the inside of the hole to prevent air leaking out of the tyre, it also seals the inner liner of the tyre from steel belted portion of the tyre. The Tyre Seals tyre repair seals out road moisture that would normally invade the steel belts of the tyre through the puncture opening from the outside of the tyre.

Contents

- 1 Open eye needle (long)
- 1 Rasp
- 1 Lube/Cleaner
- 1 Knife
- 30 Repairs (200 mm)



<p>PU-115327</p>	<p>PU-115328</p>	<p>PU-115329N</p>
<p>Open eye needle (car)</p>  	<p>Open eye needle (truck)</p>  	<p>Rasp</p>  
<p>PU-115270</p>	<p>PU-115271</p>	
<p>100 mm String 60pc</p>  	<p>200 mm String 30pc</p>  	
<p>PU-112086</p>	<p>PU-112085</p>	
<p>Knife 9 mm</p>  	<p>Cleaning & adhesive gel</p>  	

POWER TOOLS
AIR TOOLS
TOOL STORAGE
HAND TOOLS
WORKSHOP EQUIPMENT
SPECIALIST VEHICLE TOOLS

PU-115999

Mushroom tyre repair set**Mushroom tyre repair set**



Mushroom style inserts are designed to "fill the injury" in passenger or vans, radial or bias-ply tyres. These mushroom ensures repair. The Plug Kit makes repairing tyres easy and convenient. No great force is needed to insert the plug into the injury, the metal probe of the plug gun slides smoothly into place, the plug can be applied by squeezing the handle on the plug gun a few times. Plugs available in 8 mm which will fill up holes up to 6 mm.

Contents:

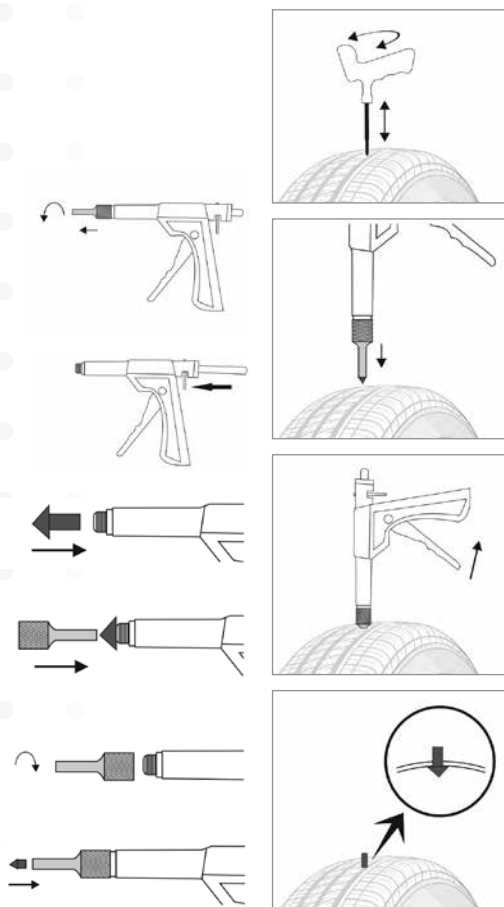
- Plug gun
- Rasp
- Nozzle 6,4 mm
- Mushroomplugs 8 mm (2x25pc)
- Scissor
- Silicone lubricant
- Knife



<p>PU-115329N</p>	<p>PU-115994N</p>	<p>PU-115996N</p>
<p>Rasp</p> 	<p>Replacement nozzle 6.4 mm</p> 	<p>Mushroom plug small 8 mm 50pc</p> 

<p>PU-115993N</p>	<p>PU-112087</p>	<p>PU-112088</p>
<p>Plug gun</p> 	<p>Scissor</p> 	<p>Silicone lubricant</p> 

<p>HU-HUS202</p> <p>Digital tread depth gauge 0 ~25 mm</p>  <p>POWER HAND POWER FOR PROFESSIONALS</p> <ul style="list-style-type: none"> ▪ Zero setting at any position ▪ Metric/Inch system interchange ▪ Suitable for tread depth, brake shoe and pad wear 	<p>SWT-SERIE</p> <p>Tyre levers</p>  <p>BOXO tools for life</p> <ul style="list-style-type: none"> ▪ Damage-free (dis-)assembly ▪ Robust design ▪ High stability ▪ Rounded ends to protect the material <table border="1"> <thead> <tr> <th></th> <th>Length (mm)</th> </tr> </thead> <tbody> <tr> <td>SWT7311-014</td> <td>350</td> </tr> <tr> <td>SWT7311-020</td> <td>500</td> </tr> <tr> <td>SWT7311-024</td> <td>600</td> </tr> </tbody> </table>		Length (mm)	SWT7311-014	350	SWT7311-020	500	SWT7311-024	600
	Length (mm)								
SWT7311-014	350								
SWT7311-020	500								
SWT7311-024	600								

POWER TOOLS
AIR TOOLS
TOOL STORAGE
HAND TOOLS
WORKSHOP EQUIPMENT
SPECIALIST VEHICLE TOOLS

BG-110

Bootgun pneumatic boot applicator



This ingenious tool, operated by air, opens up the flexible boot effortlessly enabling simple fitting onto the shaft, totally eliminating the need for lubrication and the struggling involved with the old fashioned cone method. BG-110 The Bootgun is designed and equipped with a pressure relief device to ensure maximum safety. Endurance testing under variable conditions has proven this tool to be 100% safe and reliable. The Bootgun complies to every applicable industrial safety standard.

Air inlet	1/4"
Connection	1/4" - 18 NPT
CV joint size	15 ~ 115 mm
Max. air pressure	8 bar
Weight	2.2 kg

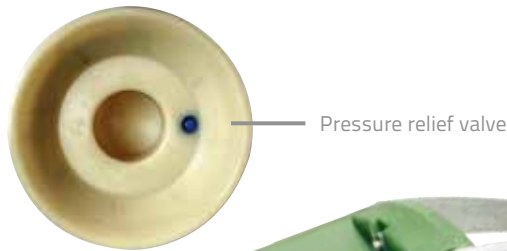

SIN-401.0001

Flexible hose clamp plier



The body of the plier has a lifetime warranty. Cable and spring are wearable items and must be replaced. Proper use ensures a long time durability. The easy access long reach hose clamp plier permits the (dis-)mounting of all self-tightening hose clamps with diameters from 11/16" (17.5 mm) to 2-1/8" (54 mm).

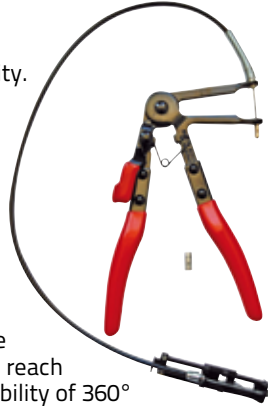

- This plier is the quickest tool available
- The jaws of the new easy access long reach hose clamp plier have a hooking capability of 360°
- The single gripper jaw helps prevent injuries
- Plier can be locked to give an easy access in narrow spaces
- Plier has a flexible 630 mm shaft
- Plier has a dipped handle for extra comfort

SIN-401.0002

Flexible hose clamp plier for clic and clic-r



The body of the plier has a lifetime warranty. Cable and spring are wearable items and must be replaced. Proper use ensures a long time durability. The easy access long reach hose clamp plier permits the (dis-)mounting of all Clic® and Clic-R® hose clamp diameters



- The jaws of the new easy access longreach hose clamp plier have a hooking capability of 360°
- The single gripper jaw helps prevent injuries
- Plier can be locked to give an easy access in narrow spaces
- Plier has a flexible 630 mm shaft
- Plier has a dipped handle for extra comfort

SIN-401.0003

Swivel head hose clamp plier



CV boot hose clamp plier for Clic® and Clic-R® type hose clamps.



- Heavy duty spring loaded plier
- Special jaws for (dis-) mounting the clamps by just one flip of the jaw
- Plier has a swivel tip for easy access and a hooking capability of 360°
- Plier has a dipped handle for extra comfort

SIN-401.0004

Tie installer & cutter



This is an essential cutter for fixing CV boots. It has a built in cutter and winding mechanism. So the band can be tightened and cut quickly and effectively. This is an essential cutter for fixing CV boots. It has a built in cutter and winding mechanism. So the band can be tightened and cut quickly and effectively.



- Plier with built in cutter
- Plier with built in winding mechanism
- Unique tool for fixing CV boots

Length (mm) 160

SIN-401.0005

CV boot clamp plier



The heavy duty CV boot clamp plier which is especially designed to mount the metal band which hold the CV boot in place.



- Plier can be used with a 1/2" power bar or ratchet
- Ideal for mounting ear type CV boot clamps
- Plier has a dipped handle for extra comfort

SIN-401.0006

CV boot band cutter



Easily cut stainless steel clamps without damaging the CV boot



- Spring loaded plier for faster action
- Special treated steel jaws
- Plier has a dipped handle for extra comfort

Length (mm) 216 mm

POWER TOOLS

AIR TOOLS

TOOL STORAGE

HAND TOOLS

WORKSHOP EQUIPMENT

SPECIALIST VEHICLE TOOLS

BG-MC-1

Stainless steel clamps - BG-MC-1



Pack size: 100pc
Suitable for 19 ~ 30 mm



BG-MC-2

Stainless steel clamps - BG-MC-2



Pack size: 100pc
Suitable for 40 ~ 125 mm



BG-CV88

Universal flexible boot maxi



- For drive shafts size \varnothing 28 ~ 40 mm
- CV-joint size \varnothing 80 ~ 125 mm
- Flexibility 600%
- Temperature range -40°C ~ 110°C
- Material Neoprene

Contents:

- Flexible boot
- Sachet 90 g grease
- 2x Stainless steel clamps



BG-CV96

Universal flexible boot



- For drive shafts of \varnothing 19 ~ 27 mm
- CV-joint size \varnothing 58 ~ 105 mm
- Flexibility 600%
- Temperature range -40°C ~ 110°C
- Material Neoprene

Contents:

- Flexible boot
- Sachet 60 g grease
- 2x Stainless steel clamps



BG-CV96-12

Bulk pack universal flexible boot BG-CV96



Contents:

- 12x Universal CV boots
- 12x Sachet 60 g grease
- 24x Stainless steel clamps



BG-CV96TWINP

Universal twin pack with fitting cone



Contents:

- 2x CV96 boots
- 2x Sachet 60 g grease
- 4x Nylon ties
- Fitting cone
- Lubricant spray (BG-MCSPRAY)



BG-FC1

Fitting cone - BG-FC1



BG-DBC100 / 200 / 300 / 400 / 500 / 600 / 700 / 800

Our boots are made from high quality neoprene rubber with excellent resistance to ozone, oil, water, abrasion, grit and temperature extremes (-40C / +115C). Suitable for replacing Thermoplastic boots and, due to their ability to stretch, easy to fit with a cone or Bootgun without dismantling the CV joint. All boots are covered by a two year warranty or 50.000 km.

BOOTGUN



CV boot 100



CV boot 200



CV boot 300



CV boot 400



CV boot 500



CV boot 600



CV boot 700



CV boot 800

BOOTGUN



POWER TOOLS

AIR TOOLS

TOOL STORAGE

HAND TOOLS

WORKSHOP EQUIPMENT

SPECIALIST VEHICLE TOOLS

BG-DBC-8

CV boot starter pack



Our boots are made from high quality neoprene rubber with excellent resistance to ozone, oil, water, abrasion, grit and temperature extremes (-40C ~ +115C). Suitable for replacing Thermoplastic boots and, due to their ability to stretch, easy to fit with a cone or Bootgun without dismantling the CV joint. All boots are covered by a two year warranty or 50.000 km. Starter pack Including 8 different CV boot kits, BG-DBC100 ~ BG-DBC800. Incl. vehicle application list.

Starter pack:

- Including 8 different CV boot kits,
- BG-DBC100 ~ BG-DBC800.
- Including vehicle application list.



BG-DBSRST1

Starter pack - 6 Semi fit stretchy steering rack boot kits



Including 6 different universal stretchy steering rack boot kits:

- BG-DBSR100
- BG-DBSR200
- BG-DBSR300
- BG-DBSR400
- BG-DBSR500
- BG-DBSR600

Cover 98% of all car applications.



BG-DBSR100

Semi fit stretchy steering rack boots kit 100

BOOTGUN

Contents:

- 2x Steering rack boots
- 4x Nylon ties
- Small fitting cone



BG-DBSR200

Semi fit stretchy steering rack boots kit 200

BOOTGUN

Contents:

- 2x Steering rack boots
- 4x Nylon ties
- Small fitting cone



BG-DBSR300

Semi fit stretchy steering rack boots kit 300

BOOTGUN

Contents:

- 2x Steering rack boots
- 4x Nylon ties
- Small fitting cone



BG-DBSR400

Semi fit stretchy steering rack boots kit 400

BOOTGUN

Contents:

- 2x Steering rack boots
- 4x Nylon ties
- Small fitting cone



BG-DBSR500

Semi fit stretchy steering rack boots kit 500

BOOTGUN

Contents:

- 2x Steering rack boots
- 4x Nylon ties
- Small fitting cone



BG-DBSR600

Semi fit stretchy steering rack boots kit 600

BOOTGUN

Contents:

- 2x Steering rack boots
- 4x Nylon ties
- Small fitting cone



POWER TOOLS

AIR TOOLS

TOOL STORAGE

HAND TOOLS

WORKSHOP EQUIPMENT

SPECIALIST VEHICLE TOOLS

BG-UB414

Universal stretchy steering rack boot kit



Made from high quality neoprene rubber to suit all cars and light commercials.

Contents:

- 2x Universal steering rack boots
- 4x Nylon ties
- Small fitting cone



BG-DBSRPS100

Universal stretchy steering rack boot kit with breather pipe



Contents:

- 2x Steering rack boots
- 4x Nylon ties
- Small fitting cone



BG-DBSRPS200

Universal stretchy steering rack boot kits with breather pipe - BG-DBSRPS200



Contents:

- 2x Steering rack boots
- 4x Nylon ties
- Small fitting cone



BG-DBSRPS300

Universal stretchy steering rack boot kits with breather pipe - BG-DBSRPS300



Contents:

- 2x Steering rack boots
- 4x Nylon ties
- Small fitting cone



HU-AB70897

Steering rack end wrench 33 ~ 41 mm



- Use on steering racks to service inner tie rod ends.
- Diameter 33 ~ 41 mm



HU-AB70950

Steering rack end wrench 38 ~ 48 mm



- Steering rack end wrench 38 ~ 48 mm
- Ideal for light trucks and SUV's.



U-SIN-170.0100

CV joint assembly removal tool



VVG004

CV banding & cutter tool set 3pc



- Built in winding mechanism
- Essential tool for fixing CV boots
- For quick and easy tensioning and cutting endless hose-bands
- To open or cut "earless" clamp-bands on CV-joints, drive-shafts, radiator hoses, fuel lines etc.
- For easy installation of all ear-type clamps on fuel filters, water pumps, other cooling system hose and CV joint clamps
- For tightening of clamps on cv boots, water and fuel hoses
- Can be used by hand or with the assistance of an extension power bar, if required.
- No damage to spring band clamps
- No damage to hoses
- Easy and quick replacement of hoses



VVP006

Turnbuckle shock absorber top lid set 20pc



- Hex-socket: 16, 17, 18, 19, 21, 22, 24, 27 mm
- Inside slotted : 5.2, 6, 8, 10, mm
- Allen key: 6, 7, 8 mm
- Inner spline M12, Tx T50
- Hex insert: 8, 9, 10 mm



VVP001

Turnbuckle for shock absorber top lid set 39pc



- T-socket: 10.5x3.5, 12.5x3.5, 14.5x5, 14.5x3, 14x2.5
- Deep sockets: 14, 16, 17, 18, 19, 21, 22, 24, 27 mm
- SL-bit: 3, 3.5, 4 mm
- DF-bit: 4, 5.2, 6, 6.3, 7, 8, 9, 10, 12 mm
- H-bit: 5, 6, 7, 8 mm
- M-bit: 12 T-bit: 50, 60
- D-bit: 5, 10 mm
- Inside Hex: 8, 9, 10, 11 mm



POWER TOOLS

AIR TOOLS

TOOL STORAGE

HAND TOOLS

WORKSHOP EQUIPMENT

SPECIALIST VEHICLE TOOLS

VVP002

MacPherson spring compressor set



- Specifically designed for MacPherson struts fitted to most vehicles
- Complete with robust shaft that extends up to 300 mm
- 3 sizes of pressure plates from 65 mm to 195 mm
- The anti-slip locking mechanism ensures the struts are compressed safely
- An adaptor for conical springs fitted to some Alfa Romeo, Chrysler, Nissan, Seat, Volkswagen is included



VP002-1

Fixed vice/bench bracket for VVP002



- Enables safe work off the vehicle
- Vice-mountable - Can be bolted to any surface
- Compatible with VVP002



VVP005

Universal spring compressor



- For use with MacPherson struts
- The spindles are equipped with contra-rotating threads which eliminate the risk of slipping round the spring
- Three shaft sizes to best suit the size of the spring
- Compression length: 65 ~ 320 mm

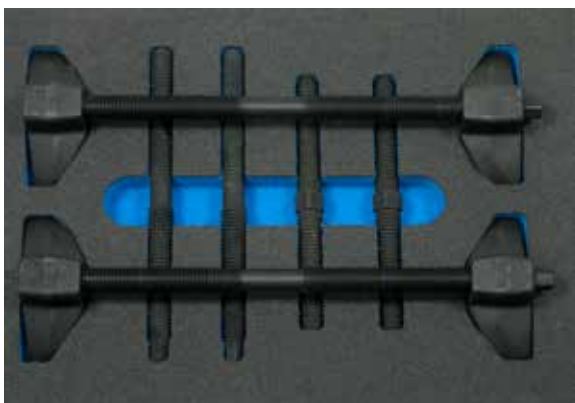

VVP003

Spring compressor for wishbone & multilink suspension for Mercedes-Benz



- Telescopic compressor for shock absorber springs
- Suitable for removing and positioning helicoidal springs within multi-link, independent arm suspension systems - both front and rear
- Supplied with two pairs of interchangeable caps provided with a three-hook safety system
- No need to de-mount spring, saving you time!
- 70 ~ 130 / 90 ~ 150 mm

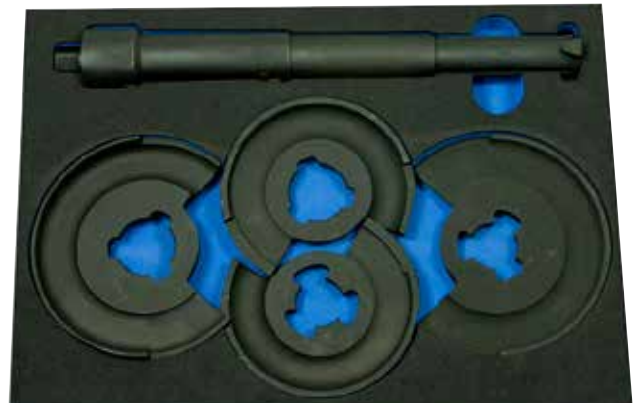

BRAKE TOOLS

PH-BFT-2

Hand-held brake pipe flaring tool

Lightweight and easy-to-use, the new Powerhand brake pipe flaring tool will flare steel and cupra nickel tubing. Manufactured in the UK from high quality sintered steel, the flaring tool is built to last in the toughest of workshop environments.

- The simplicity of this tool makes the tricky task of brake flaring on the vehicle straight-forward
- No pushing back ensures that the flare form is correct every time
- Distinctly lighter than other flaring tools on the market, weighing only 420 g
- Europe wide registered design
- Ideally used with two ratchet ring spanners (16 & 10 mm)
- Kit contains 3/16" SAE 4.75 mm DIN tools. See table below for further sizes available.



	PH-BFT2	PH-BFT25	PH-BFT26	PH-BFT5	PH-BFT6
Tube sizes	3/16" / 4.75 mm	3/16" / 4.75 mm / 5 mm	3/16" / 4.75 mm / 6 mm	5 mm	6 mm
Flare form	SAE/DIN	SAE/DIN	SAE/DIN	DIN	DIN



PH-BFT-316

3/16" Hand-operated brake line flaring tool

- SAE
- 3/16"
- 420 g



PH-BFT-475

4.75 mm Hand-operated brake line flaring tool

- DIN
- 4.75 mm
- 420 g



PH-BFT-14

1/4" Hand-operated brake line flaring tool

- SAE
- 1/4"
- 420 g



PH-BFT-5

Hand-operated brake line flaring tool 5 mm

- DIN
- 5 mm
- 420 g



PH-BFT-6

Hand-operated brake line flaring tool 6 mm

- DIN
- 6 mm
- 420 g



POWER TOOLS

AIR TOOLS

TOOL STORAGE

HAND TOOLS

WORKSHOP EQUIPMENT

SPECIALIST VEHICLE TOOLS

SIN-160.0004**Brake rewind kit 18pc**

Master sets of adaptors for a wide range of vehicle applications. Suitable for push back and wind back brake pistons. Includes left and right-handed thrust bolt assemblies. Precision made adaptor plates help prevent damage to pistons and seals.

Contents:

- Alfa Romeo (incl. 164, 2.0)
- Audi (incl. 80, 90, V8 + 100)
- Austin
- BMW
- Citroën (incl. XM, Xantia u. a.)
- Ford (incl. Sierra ABS, Scorpio ab 85)
- General Motors
- Honda (incl. Prelude)
- Jaguar
- Mazda
- Mercedes Benz
- Mitsubishi
- Nissan (incl. Primera, Silvia 1.8 Turbo)
- Opel Astra
- Rover (incl. 8000)
- Saab (incl. 9000)
- Subaru L + Z
- Toyota
- VW (incl. Golf, Golf IV, Passat)

POWER HAND®
POWER FOR PROFESSIONALS

**SIN-160.0005****Brake rewind kit 35pc**

Master sets of adaptors for a wide range of vehicle applications. Suitable for push back and wind back brake pistons. Includes left and right-handed thrust bolt assemblies. Precision made adaptor plates help prevent damage to pistons and seals.

Contents:

- Alfa Romeo
- Audi (incl. 80, 90, V8 + 100)
- Austin
- BMW (incl. Mini)
- Citroën (incl. XM, Xantia u. a.)
- Fiat
- Ford (incl. Sierra ABS, Scorpio ab 85)
- Honda (incl. Prelude)
- Jaguar (incl. S Type)
- Lancia
- Mercedes Benz
- Mitsubishi
- Nissan (incl. Primera, Silvia 1.8 Turbo)
- Opel
- Peugeot
- Proton
- Renault (incl. Clio, Master Van, Alpine V6)
- Saab (incl. 9000)
- Seat
- Subaru (incl. L + Z)
- Toyota
- Opel Lincoln
- VW (incl. Golf, Golf IV, Passat)
- Volvo

POWER HAND®
POWER FOR PROFESSIONALS



SIN-160.0004-L

Spindle left



SIN-160.0004-R

Spindle right



SIN-160.0010

3/8"

3/8" Brake calliper wind back tool

To be used with SIN-160.0004 and SIN-160.0005. This air powered brake calliper wind back tool can be used with either a pin type or 3/8" D type drives adaptor.

- Suitable for pin type or 3/8" D type
- For left and right handed threaded pistons
- Addition to set SIN-160.0004 & SIN-160.0005
- To save time and use less hand force this is an air operated brake calliper (re)-wind tool



VB003-8

Stainless steel brake caliper brush



- For cleaning aluminium brake calipers
- Stainless steel bristles for cleaning
- Slim design for working in areas with restricted access
- Plastic handle with suspension hole
- Material: stainless steel bristles, plastic handle



VB003-9

Brass brake caliper brush



- For cleaning aluminium brake calipers
- Soft brass bristles for damage-free cleaning
- Slim design for working in areas with restricted access
- Plastic handle with suspension hole
- Material: brass bristles, plastic handle



POWER TOOLS

AIR TOOLS

TOOL STORAGE

HAND TOOLS

WORKSHOP EQUIPMENT

SPECIALIST VEHICLE TOOLS

VVB001

Brake caliper wind back kit 18pc



- Winds back brake piston for replacing brake pads
- Suitable for right or left-handed use
- Helps to prevent damage to pistons and seals
- Suitable for a wide variety of vehicle applications including Audi, BMW, Ford, Toyota and VAG

Contents:

- Left-handed T-bar
- Right-handed T-bar
- 15x adaptors
- Reaction plate holder



VVB004

Add-on adaptor kit for B-VVB001 19pc



- For use with the B-VVB001
- Designed for push back and wind back broken pistons
- Wide range of vehicle applications

Contents:

- 15x adaptors
- 4x plate holders

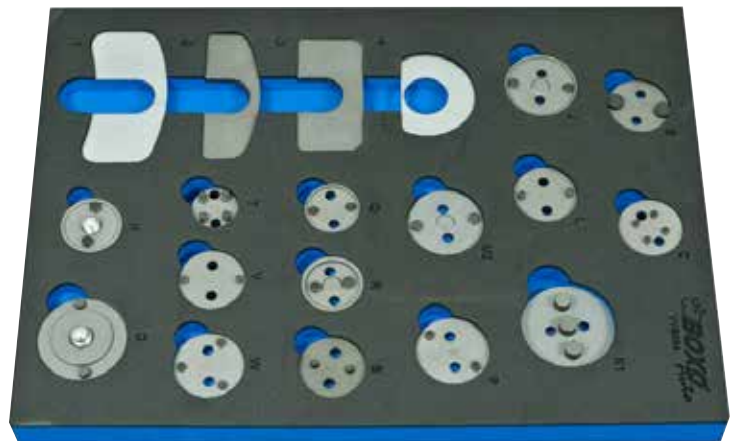

VVB006

Brake caliper wind back kit 16pc



- Winds back brake piston for replacing brake pads air operated
- 15 special adaptors and a reaction plate
- Air operated



VVB003

Brake tool set 15pc



- A variety of general brake tools for use in the workshop
- Kit especially designed for brake maintenance and repair identify percentage of water in brake fluid
- Wide range of vehicle applications



VVB005

Brake bleeder set



- Suitable for anti-lock brake systems
- Integrated Venturi-system creates a vacuum with standard workshop air supply
- Universal plastic nozzle for all common vehicle types
- Clear transparent brake fluid hose for visibility
- Removes fluid via bleed nipples for bleeding or entire fluid replacement

Contents:

- 1 liter brake fluid bottle with fixed nozzle
- 1 liter brake fluid bottle with flexible nozzle
- 1 liter vacuum brake bleeder



VB416

Brake fluid tester



- Identify percentage of water in brake fluid
- Essential safety check
- Quick and simple tool
- Colour coded LED's show level of water
- Battery supplied



VVE040

Vacuum pump/brake bleeding kit



For testing:

- Automatic transmissions/ vacuum modulators
- Body and accessories, vacuum reservoirs, air conditioning and heating, heater cores
- Brake systems, antilock brake system, conventional brake system, power brake system
- Computerized engine control system, Ford EEC-III and MCU system, Chrysler electronic fuel control system, American motors engine controls
- Emission control system, heated-inlet air system, EGR system



HU-HUS210

Digital brake gauge 0 ~ 100 mm



- LCD Display
- Zero setting at any position
- Metric/Inch system interchange



Range	0 - 100 mm
Resolution	0.01 mm

POWER TOOLS

AIR TOOLS

TOOL STORAGE

HAND TOOLS

WORKSHOP EQUIPMENT

SPECIALIST VEHICLE TOOLS

VVE012

Diesel injector seat cutter set 7pc



- Used for re-cutting injector seats when reconditioning diesel injectors

Contents:

- 15x19 mm universal flat cutter
- 17x17 mm angled cutter (Mercedes CDI)
- 17x17 mm angled cutter (Fiat/Iveco)
- 17x19 mm flat cutter (Mercedes CRD)



HU-HU35005

Multi-voltage glow plug tester



- Test the status of diesel glow plugs
- Indicates open circuit and short circuit
- Indicated state of glow plug, displaying resistance
- Universal - works on all types of glow plug
- User friendly
- Easy-to-read results
- High quality interchangeable leads
- Oil resistant cable
- 2x AAA batteries



HU-HU41034

Diesel injector extractor kit



- Suitable for the removal of frozen Bosch /Delphi/Denso/ Siemens diesel injectors
- Flexible joint allows the slide hammer to be used in restricted area

Contents

- M27x1.0 Siemens
- M25x1.0 Siemens
- M20x1.0 Denso
- M16x1.0 Toyota 2.2
- M14x1.5 BMW m47, MB W211cdi
- M17x1.0 MB Bosch
- M18x1.5 adaptor
- Special 10 mm hex bit for nozzle extractor (tamperproof 6 mm)
- Special 10 mm hex bit for nozzle extractor (tamperproof 7 mm)



SIN-900.0500

Diesel injector removal set 4pc



- Designed specifically for the removal of Delphi/Bosch diesel injectors
- Set of 3 adaptors and a special tool for removing the internal part of Bosch injectors
- Can be used with a slide hammer or with an air tool (to loosen the injectors)
- Saves you time and money!



HU-HU41005

Diesel injector seal extractor



- Removes stuck copper injector base seals
- Adjusts easily to inner diameters from 6.4 mm to 9.5 mm
- Adjustable depth of the expandable collet



HU-HU41008

1/2" Diesel injector dismantling tool



- Suitable for removing the internal part of Bosch injectors
- 10 mm max. tamperproof bit



MC-NDP7-SERIE

Locking nut drivers 7 mm

Locks onto Hex Screws

Available in 3 lengths the Nut Driver ensures faster and easier work in confined spaces, and is fully operable with just one hand - simply: engage, lock-on, work, and disengage.

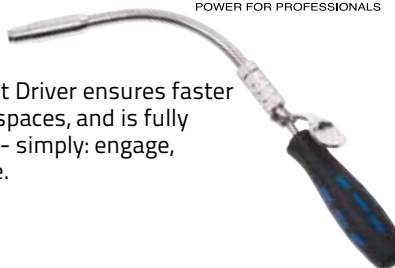

	Length (mm)	Hex size (mm)
X-MC-NDP7-190	190	7
X-MC-NDP7-290	290	7
X-MC-NDP7-490	490	7
X-MC-NDP7-SF	330	7-flex



VVE041

Engine Oil Pressure Tester



VVE019

Universal radiator pressure tester set 20pc

- Test cooling system for leaks



HU-AB70880

Cooling system refilling gun



- Eliminates airlocks during refilling using deep vacuum technology
- Unique multi-fit cone eliminates the need for additional adaptors (universal use)
- Easy and fast to use

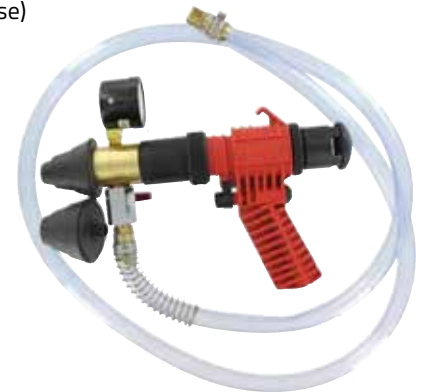

VVG003

Hose clamp plier set 11pc

- For replacement of hose-clips on Fuel-lines, oil-pipes and water-hoses
- Special design allows the spring hose clips to be securely gripped and safely expanded
- Contents different styles of hose clamp pliers which will service most of the flat-band ring style and CLIC-R hose clamp, also others
- Includes seal puller, slot driver and VG003-1 ~ 7



POWER TOOLS

AIR TOOLS

TOOL STORAGE

HAND TOOLS

WORKSHOP EQUIPMENT

SPECIALIST VEHICLE TOOLS

SIN-401.0010

45° Ratcheting hose clamp: 1 - 26 mm

- 1 ~ 26 mm
- 45°

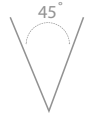

SIN-401.0015

45° Ratcheting hose clamp: 1 ~ 40 mm

- 1 ~ 40 mm
- 45°

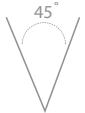

SIN-401.0020

45° Ratcheting hose clamp set 2pc

- 1 ~ 26 mm
- 1 ~ 40 mm

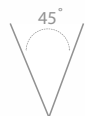

VE476

Flexible hose clamp set 3pc

- Ideal for use on flexible brake, fuel, heater and radiator lines
- Hi-vis colour for easy location
- Lightweight and non-conductive
- Jaw diameter: 1/2" to 3/4"



HU-HU414

Automotive refractometer

- Coolant: from 0 ~ -50°C
- Battery: from 1.1 ~ 1.4 kg/l
- Break fluid: from 0 ~ -40°C
- Test antifreeze, battery acid and screen wash
- Easy focusing adjustable eyepiece
- Complete with pipette and pouch



HU-HU13002

Illuminated refractometer

- Backlit for easy results reading
- Coolant: 0 C - 50 C
- Battery: 1.1 ~ 1.4 kg/l
- Screen wash: 0 C - 40 C
- AD Blue separated scale: 30% - 35%



VVE005

Valve seal removal & installer set 11pc



- Works on seated or removed valves
- Precision made seal driving adaptors for correct setting of valve seal

Contents:

- Valve stem seal pliers (Ford, Nissan, Opel, VW)
- 150 mm drive handle
- 2x deep seal driving sockets
- 7x seal driving adaptors



VVE008

Ignition coil puller (VW/Audi) 4pc



- 3x T-bar ignition coil pullers for use on Volkswagen and Audi vehicles fitted with direct ignition engines
- For installing and removing ignition coils with final output stage
- With T-Handle



VVE035

3/8" 1/2"

3/8" & 1/2" Oxygen sensor socket set 7pc



- For use on lambda sensors (oxygen sensors)
- This tool covers a wide variety of options and fits most heated and non-heated sensors

- 1/2" = 29x90 mm, 27x82 mm, 7/8" (22 mm)x50 mm
- 3/8" = 7/8" (22 mm)x90 mm, 7/8" (22 mm)x80 mm, 1-1/16"x74 mm, 7/8" (22 mm)x31 mm
- Applications = Audi, Citroën, Ford, Mercedes, Peugeot, Renault, Skoda, Opel, VW



VVE011

3/8"

3/8" Glow plug & spark plug socket set 6pc



- Designed to grip plug being extracted
- Extra-long for greater access - 158 mm
- Wide variety of vehicle applications
- 3/8" sizes: 8, 9, 10, 12, 14, 16 mm



VVE039

Vacuum & pressure tester



- Creates and holds a metered vacuum for testing a variety of automotive, marine, aircraft and agricultural equipment
- Can be used for vacuum testing and one-man brake bleeding
- Application areas include, automatic transmission, air conditioning and heating, brake systems, engine management systems, piston ring retainers on diesel engines, valve stem oil seals and much more
- Applications: Audi, BMW, Chrysler, Citroën, Mercedes, Nissan, Renault, Rover, Opel, Volvo
- -30 ~ 60 PSI
- 0 ~ 4 Bar



VVE040

Vacuum pump/brake bleeding kit



For testing:

- Automatic transmissions/ vacuum modulators
- Body and accessories, vacuum reservoirs, air conditioning and heating, heater cores
- Brake systems, antilock brake system, conventional brake system, power brake system
- Computerized engine control system, Ford EEC-III and MCU system, Chrysler electronic fuel control system, American motors engine controls
- Emission control system, heated-inlet air system, EGR system



POWER TOOLS

AIR TOOLS

TOOL STORAGE

HAND TOOLS

WORKSHOP EQUIPMENT

SPECIALIST VEHICLE TOOLS

VVE044

Petrol cylinder compression tester



- Stem with release valve and quick release chuck for attaching fittings
- Displays in psi/bar (0 ~ 300 psi) (0 ~ 20 bar)
- The flexi hose is fitted with a dual M14, M18 adaptor
- The set is complete with spare washers
- Long reach adaptors M10, M12, M14
- Suitable for wide variety of petrol engines



VVE045

Piston service tool set



- Contents:**
- 53 ~ 125 mm
 - 2x 90 ~ 175 mm
 - 50 ~ 100 mm
 - 1/16" ~ 3/16" 2.0 ~ 4.5 mm
 - 1.2 ~ 5.5 mm



VVC006

Universal clutch alignment 5pc



- For clutch - hub 14.4 ~ 29 mm
- Clutch alignment and assembly
- Vehicles equipped with late-model front wheel drives without pilot bear in flywheel
- Small cone: range 14.4 ~ 21 mm
- Large cone: range 20.9 ~ 29 mm



VVC003

Universal clutch alignment rectifier set 15pc



- For all modern clutches excluding DSG
- Suitable for manual passenger vehicles and light commercials
- Can be used with most vehicles with single disc & some vehicles with double discs
- Fixed size adaptors: 10, 12, 14, 15, 16, 17, 19, 25, 27, 30 mm



VVE007

Valve spring compressor set 8pc



- Pusher sizes: 16, 19, 23, 25, 30 mm
- C-type
- 5x applicators to easily compress and fit the valve spring correctly
- Suitable for cars and motorcycles



HU-AB70993

Universal stretch belt mate kit



- Stretch belt mate™ is the stretch belt tool that requires the least 'man handling' from the technician on the market
- Universal stretch fit belt installation and removal tool set
- No adjustment needed

- Contents:**
- Removal tool
 - Installation tool



HU-AB70906B

Universal timing gear holder



- Used to hold the gear while the cam shaft bolt is removed
- Allows adjustment of cam gear once installation is complete
- Slimline design allows maximum access
- Single lever design is quick and easy to use
- Provides breaker bar strength for maximum holding force
- Material: fibre reinforced polymer (nylon)



HU-AB70899

Cam clamp kit



- Hold valve timing on overhead cam engines during timing belt service
- Patented 'Uni-Fit' positive lock tooth
- Easy to use, installs in seconds
- Suitable for securely engaging all cam gear size



HU-AB70908B

Universal timing gear holder kit



Contents:

- Nylon timing gear holder
- 4x Single cam clamps



HU-AB70961

Camshaft & crankshaft seal tool kit



- Universal tool suits all vehicles
- 7 installation mandrels suit 21.5 mm through 64 mm seals
- Removal : compact puller with unique extracting hooks engage seal for quick removal (2 pairs of hooks)
- Installation : interchangeable "seal mandrels", use vehicle crank or cam bolt to evenly press seal into position
- Material: fibre reinforced polymer (nylon)
- Suitable for 21.5 ~ 64 mm seals



POWER TOOLS

AIR TOOLS

TOOL STORAGE

HAND TOOLS

WORKSHOP EQUIPMENT

SPECIALIST VEHICLE TOOLS

HU-AB70586

Combustion leak test kit



- A quick and effective way of checking a vehicle radiator to see if combustion gas is present
- Size 568 ml



HU-HU12007

Cylinder leak test kit



- Locate and measure compression leaks in the cylinder
- Pin-points bad valves, cracked cylinders and blowing/leaking gaskets



HU-HU12012

Turbo system tester



- Delivered with 8 conical caps from 35 to 90 mm
- Caps with rugged surface for a better grip in the tubes
- Includes a gauge with integrated regulator for accurate reading
- Allows the technician to pressurize the whole turbo and inlet system in order to detect quickly and accurately potential leaks



SIN-604.0001

Wire brush set 20pc



- Comprehensive wire brush set
- Ideal for a variety of uses
- 150 mm extension with quick chuck
- Comfort-grip handle
- Stainless steel, brass & nylon brushes 9 ~ 19 mm



PULLERS

X-SIN-250.0005

3/8"

3/8" Universal drive ribbed pulley puller



- No engine removal required. For removing ribbed drive pulleys on crankshafts, alternators, air conditioning units and waterpumps.
- Special jaw design engages on the pulley 'V' grooves whilst avoiding the belt retaining guards.

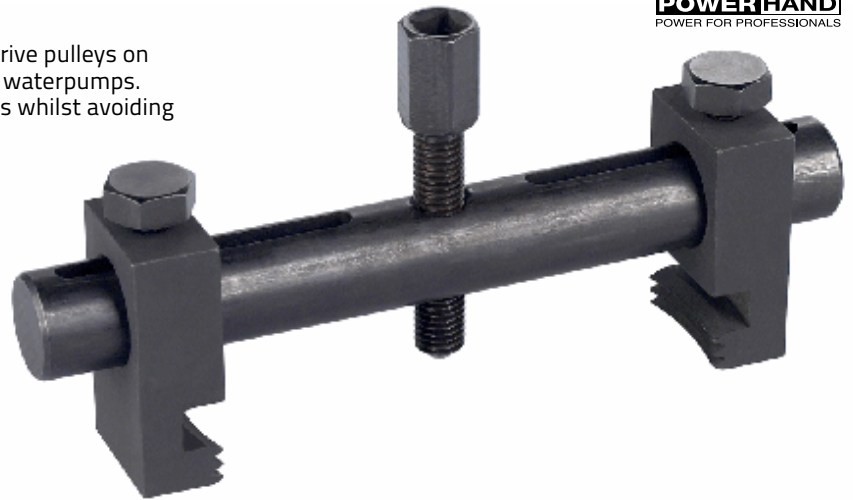

B-AE-SERIE

Reversible pullers



- Easily adjustable and geared jaws for internal and external use
- Made from tough Chrome Molybdenum steel
- Suitable for pulling hubs, flanges, gears and bearings
- Ratcheting mechanism to locate and hold the legs in the correct position
- Faster and easier than conventional pullers



	Size	Capacity
B-AE-2TON	50 ~ 100	2 ton
B-AE-5TON	100 ~ 200	5 ton
B-AE-7TON	125 ~ 220	7 ton

VVD015

Universal slide hammer set



- 2.2 kg hammer with 570 mm shaft
- 2 jaw + 3 jaw for internal
- 2 jaw + 3 jaw for external
- Lip, hub and dent puller attachments



POWER TOOLS

AIR TOOLS

TOOL STORAGE

HAND TOOLS

WORKSHOP EQUIPMENT

SPECIALIST VEHICLE TOOLS

VVA003

3 Jaw internal/external puller set



Sizes internal
15 ~ 30 mm
30 ~ 80 mm

Sizes external
15 ~ 80 mm



VVA006

2 & 3 Jaw CRV gear puller set



- The jaws on this gear puller can be changed to operate with 2 or 3 jaws with internal or external pulling action 75 ~ 180 mm
- Simply unscrew the knurled screw cap to release spring and jaw cover, unhook the jaws and reposition as necessary
- Removable thrust plate protects against damage to the shaft end

Sizes 75 ~ 180 mm
Internal/external



VVA008

Blind hole bearing puller set (8 ~ 32 mm)



- Expand internal clamp by turning handle clockwise to force against the inside of the bearing race for extracting evenly without damaging the parts
- 940 g hammer with 390 mm shaft

Clamp sizes:

8-10, 10-12, 12-14, 15-17, 17-20, 20-24, 25-29, 30-32 mm



VVR004

Micro-engineering puller kit 13pc



- Use on both internal and external bearing
- Enables removal of bearings where normal pullers are unable to be used by locking into the bearing race itself



VVR006

Flange-type steering wheel puller set 18pc



- The steering wheel lock plate compressor is also included, to compress the steering wheel lock plate to remove or install the snap ring
- Removing steering wheels of most vehicles with or without telescoping tilt steering columns is easy with this new set



VVR007

Tie-rod/ball joint 5pc



- 1 Handle for use with hammer
- Forks made of drop forged heavy duty chrome vanadium steel
- 1 Handle designed for use with pneumatic air hammer
- Both handles are interchangeable
- 3 drop forged forks: 11/16, 15/16" & 1-1/8"



VVS002

Two sets bearing separator kit 30 ~ 75 mm 12pc



- Two versatile gear and bearing splitters
- Complete set of accessories
- Bearing separator, Sizes range from 30 ~ 50 mm and 50 ~ 75 mm
- Dropped forged and hardened
- Pullout the bearing with the H-type beam and bolts



VVS003

Bearing separator kit 75 - 105 mm 11pc



- Bearing separator and bolts are dropped forged and hardened
- Heavy duty gear and bearing splitter
- Pullout the bearing with the H-type beam and bolts
- Bearing separator, capacity 75 ~ 105 mm



POWER TOOLS

AIR TOOLS

TOOL STORAGE

HAND TOOLS

WORKSHOP EQUIPMENT

SPECIALIST VEHICLE TOOLS

SIN-250.0006

Oil pan separator & cleaning set



- Breaks gasket seals on engine sumps, transmissions and gasket joints
- Includes surface conditioning pads



SIN-250.0007

Oil sump plug set 15pc



- Integrated magnets make applying and removing oil sump plugs quicker and easier
- The risk of losing the plug is eliminated
- The user is kept clear of offending fluids



Drive: 3/8"
 Bits: H8, H10, H12, H13, H14, H17, S8, S10, T45
 Sockets (mm): 13, 14, 17, 18, 19, 21

SIN-900.0501

Oil drain pan without grill



- 16 liter capacity



VVE034

3/8"

3/8" Drain plug key set 17pc



- Includes:**
- Triangle 10 mm
 - SX10
 - Square: 7, 8, 10, 11, 12, 13, 1, 14 mm
 - Square: 3/8"
 - M16
 - Hex: 8, 9, 10, 12, 14, 17 mm



X-SIN-900.0530

Magnetic oil drain plier



- Safely drain old and hot engine oil, transmission fluid and gear oil
- Powerful 90 N magnet for superior grip on oil sump plug
- Comfort grip handle
- Made from chrome and steel
- Length 285 mm



SIN-900.0504

Quick fluid stopper set 12pc



- Ideal for stopping fluid escaping from open fuel, brake and transmission lines
- Various stops provided to suit different fuel line connectors

- Contents:**
- 2x Injection hose stops
 - 2x Fuel supply adaptors
 - 1x Extended flexible hose clamp
 - 1x Pipe separator
 - 6x Flexible pipe stops (various)



U-SIN-900.0550

Oil drain plug repair kit 114pc



Contents:
M13x1.25 mm
M13x1.5 mm
M15x1.5 mm
M17x1.5 mm
M20x1.5 mm
M22x1.5 mm



SIN-900.05-SERIE

Oil drain plugs



U-SIN-900.0551	5x M13x1.25 mm
U-SIN-900.0552	5x M13x1.5 mm
U-SIN-900.0553	5x M15x1.5 mm
U-SIN-900.0554	5x M17x1.5 mm
U-SIN-900.0555	5x M20x1.5 mm
X-SIN-900.0556	5x M22x1.5 mm

X-SIN-900.0545

Oil filling funnel set 8pc



HU-HU4600-SERIE

Vehicle fluid change syringes

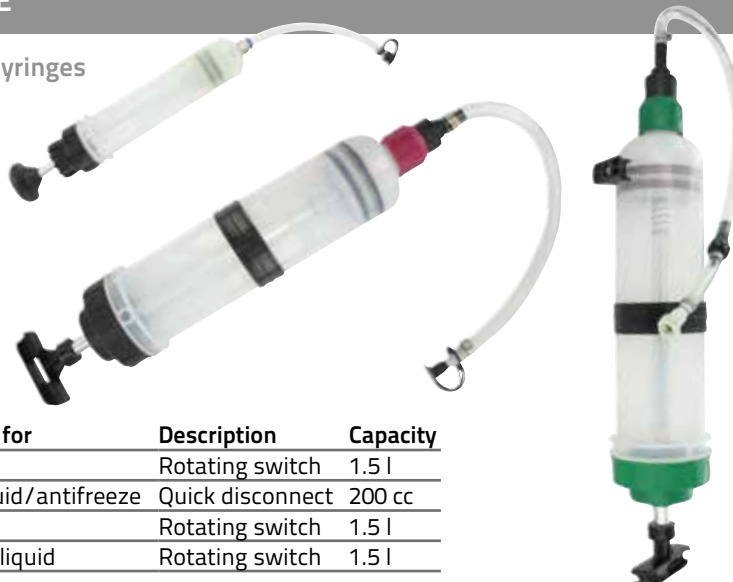

	Suitable for	Description	Capacity
HU-HU46008		Rotating switch	1.5 l
HU-HU46009	Brake fluid/antifreeze	Quick disconnect	200 cc
HU-HU46011	Fuel	Rotating switch	1.5 l
HU-HU46012	AD Blue liquid	Rotating switch	1.5 l

HU-HU12015

Diesel priming & bleeding kit



- For bleeding or priming diesel systems
- For connection in-line with the vehicle's low pressure delivery system
- The clear pipes allow any air bubbles in the system to be seen
- Great time saver
- Applications: VW, Mercedes, Peugeot, Citroen, Renault, Fiat, Opel, Rover, Ford



HU-MI7201

Manual vacuum/pressure fluid evacuator



Designed for extracting and dispensing all types of lubricating, transmission, engine oils and coolants from all types of combustion engines and industrial machinery.

- No power or air needed
- Automatic shut-off valve
- Small & portable

Contents:

- Fluid evacuator/dispenser
- 0.23" OD x 5' long (5.7 mm OD x 1.5 m long) dipstick tube
- 0.26" OD x 5' long (6.6 mm OD x 1.5 m long) dipstick tube
- 0.41" OD x 5' long (10 mm OD x 1.5 m long) main evacuation tube
- Tube adaptors
- Capacity 8.8 l
- Weight 3.5 kg



HU-MI6403

3 in 1 Fluid dispenser 5 L



- Dispenses fluids to fill or top-up master cylinders, coolant bottles, automatic transmissions, differentials, power steering and other reservoirs
- Used to dispense fluid to top-up or refill sealed automatic transmissions
- Delivered with the master cylinder adaptor for brake bleeding (clutch)
- Fluid under pressure for smooth continual flow
- Integrated manual pump adds air above the fluid level to prevent aeration
- Sealed internal pump components
- On/Off and flow control valve are conveniently located near fluid output
- Gauge indicates fluid dispensing pressure
- Integrated safety and manual pressure relief valve

Contents:

- Fluid dispensing system
- ATF refill adaptor kit
- Universal master cylinder adaptor

Capacity: 5 l



HU-MI6413

3 in 1 Fluid dispenser 10 L



- Sealed automatic transmissions
- Brake bleeding (clutch)
- Fluid under pressure for smooth continual flow
- Integrated manual pump adds air above the fluid level to prevent aeration
- Sealed internal pump components
- On/Off and flow control valve are conveniently located near fluid output
- Gauge indicates fluid dispensing pressure
- Integrated safety and manual pressure relief valve

Contents:

- Fluid dispensing system
- ATF refill adaptor kit
- Universal master cylinder adaptor

Capacity: 10 l



U-SIN-900.0535

Hinged oil filter chain wrench
60 ~ 105 mm



U-SIN-900.0540

Hinged oil filter chain wrench
60 ~ 160 mm

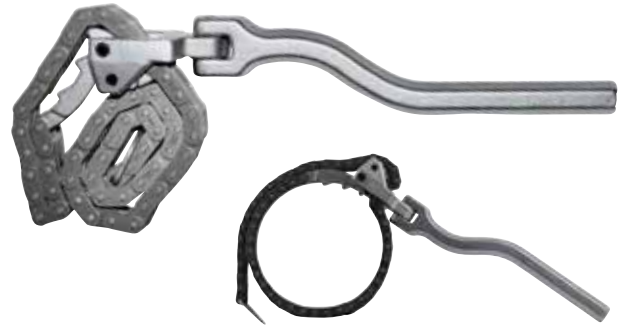

PR9110-SERIE

Oil filter pliers



- Right angle, laser heat-treated teeth grip better and last longer
- PermaLock® fastener eliminates nut and bolt failure



	Size (mm)	Capacity (mm)
U-PR9110-228	225	44 ~ 89
U-PR9110-305	300	70 ~ 108
U-PR9110-394	385	847 ~ 140

HU-AB71180

1/2"

1/2" Oil filter wrench & drainer (Toyota)



- 1/2" square drive and 24 mm hex
- Extra Heavy-Duty to withstand high torque required to remove the oil filter housings on these vehicles
- Recommended Tension for Toyota filter housings is 25 Nm however, if the housings are over tensioned the force required to remove can exceed 10 times this - This tool has been tested to breaking in excess of 400 Nm
- Designed for 4, 6, 8 cylinder Toyota & Lexus vehicles
- Material: Cr-V



VE423

Swivel jaw filter wrench pliers 57 ~ 120 mm



- Jaws swivel 90° in either direction to access most oil and fuel filters
- Works where other oil and fuel filter pliers and wrenches don't
- Jaws adjust to 4 positions in 30° increments to fit most applications
- Slip-joint handle
- Sure grip teeth prevent slipping
- Cushioned handles provide comfort
- Two sizes available



VE424

Swivel jaw filter wrench pliers 80 ~ 190 mm



- Jaws swivel 90° in either direction to access most oil and fuel filters
- Works where other oil and fuel filter pliers and wrenches don't
- Jaws adjust to 4 positions in 30° increments to fit most applications
- Slip-joint handle
- Sure grip teeth prevent slipping
- Cushioned handles provide comfort
- Two sizes available



VVE001

3/8"

3/8" Oil filter socket set 5pc



- Oil filter sockets: 24, 27, 32, 36, 38 mm



VVE002

3/8"

3/8" Cup type oil filter wrenches set 9pc



- Use with 3/8" or 21 mm Spanner



VVE047

3/8"

3/8" Cup type oil filter wrenches set - Japanese/US/AU cars 15pc



- These cup-type filters are made of 7 & 16 gauge construction and are able to withstand up to 85 ft. lbs of torque
- Cup-type design grips like a socket minimizing the possibility of crushing filters
- Fits 3/8" or 1/2" square drive tool coated with electro-black oxide finish for protection against rust

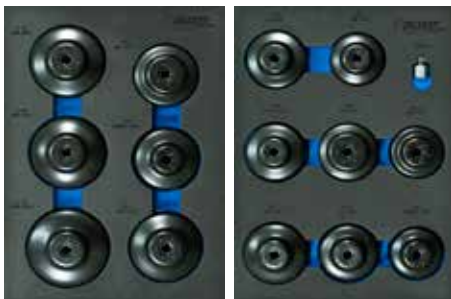

VVE046

3/8"

3/8" Cup type oil filter wrenches set - Euro cars 16pc



- These cup-type filters are made of 7 & 16 gauge construction and are able to withstand up to 85 ft. lbs of torque
- Cup-type design grips like a socket minimizing the possibility of crushing filters
- Fits 3/8" or 1/2" square drive tool coated with electro-black oxide finish for protection against rust

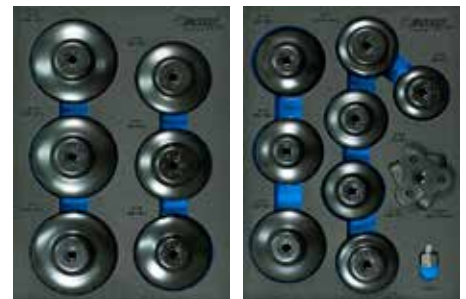

VVE003

3/8"

3/8" Cup type oil filter wrenches set 30pc



- These cup-type filters are made of 7 & 16 gauge construction and are able to withstand up to 85 ft. lbs of torque
- Cup-type design grips like a socket minimizing the possibility of crushing filters
- Fits 3/8" or 1/2" square drive tool coated with electro-black oxide finish for protection against rust



SIN-900.0560

3/8"

3/8" Cup type oil filter wrench set, 16pc



TORQUE MULTIPLIERS

VVG005

Snap ring plier set 13pc



- Reversible for inner or outer circlips
- Straight, bent and angled
- Comfort-grip handles
- Heat-treated spring-steel
- Lightweight
- Straight and angled hooks



Contents:
 Straight, 45° & 90°
 for inner/outer circlip sizes
 8 ~ 18, 12 ~ 25, 18 ~ 48, 31 ~ 82
 1/16" bent pliers for shafts



PH-3510

Torque multipliers 5200 Nm



Compact, robust and designed for the professional. The Powerhand Torque multipliers will loosen the tightest wheel nuts on trucks, agricultural machines and other heavy vehicles. This maintenance free unit utilises planetary gears to deliver a ratio of 1:56, giving a maximum torque output of 5200 Nm. Delivered complete with 32 mm and 33 mm impact sockets packed in a heavy duty polyethylene carry case.

- 210 mm extension
- Maximum breaking torque 5200 Nm
- Simple and safe operation
- No need of long breaker bars
- Lightweight 5.6 kg
- Maintenance free
- Compact storage box 39x12x25,5 cm
- 32 + 33 mm

NEW GENERATION!



No damage on the Hubcap

POWER TOOLS

AIR TOOLS

TOOL STORAGE

HAND TOOLS

WORKSHOP EQUIPMENT

SPECIALIST VEHICLE TOOLS

HU-HU31019

Amp Hound



- Designed to drastically reduce the amount of time needed to determine the amount of current in a fused circuit
- Ideal to locate parasitic draw
- No need to remove fuse risking a reset of the circuit
- Makes it possible to very quickly "sniff out" any currents that are flowing in an entire Fuse Block in only a few seconds
- Defect from: 0.005 A



SCWT-L690V

Universal voltage tester 12 ~ 690 V



- Can test an entire circuit from the battery to the component in question
- Determine if the relay itself is functioning properly
- Instantly determine the problem within the circuit
- No need of a multimeter : just push the button
- Features easily accessible ports for use with other diagnostic tools for further diagnostic
- Can be used as a remote control starter in engine work like compression testing, distributor or cam shaft adjusting, to run the compressor etc.



VD429

Automotive voltage tester 6 ~ 48 V



- To test for voltage presence on low voltage electrical devices
- Simply attach the alligator clip to one wire and touch the metal probe end to the other by piercing the insulation
- LED Display shows polarity
- Voltage display: 6 V, 12 V, 24 V, 48 V



PPCT

Scream'n continuity tester & voltage detector



Two distinct tones allow the user to differentiate between circuits above or below 10 ?, a further "warble" tone advises detection over 12 V.



- Adjustable volume level
- 3 Level continuity testing
- Detects voltage
- Self-powered, portable unit
- Built-in flashlight
- Tests: wire harnesses, bad connections, relays, diodes etc.
- Can be used even if no other power source is available
- Powered by 2x AA batteries



HU-HUCF02

20 A Automotive current testers standard



- Plugs directly into the fuse socket for quick, accurate amperage testing
- 20 A maximum current
- 75 cm Cable
- LCD Screen



	Blade type	Testing range	Battery
HU-HUCF02	Standard	12 V ~ 48 V	1 x 12 V
HU-HUCF02S	Mini	12 V ~ 48 V	1 x 12 V

HU-HUCF08

80 A Current tester



- Ideal for diagnosing current leaks (consumption)
- Large LCD display with graph
- Peak hold and data function
- Zero setting for accurate measurement
- Suitable for large, standard and mini blade fuses



AC/DC Current	Max. 80 A V
AC/DC Voltage	Max. 48 V V

SIN-400.3511

Digital Amp clamp meter 40 mm



- Audible continuity check
- Display and peak reading hold
- 2 readings per second
- 4 digit LCD display
- One touch auto zero
- Auto power off
- Low battery indicator



AC/DC Current	0.01 A ~ 1000 A
AC/DC Voltage	0.001 V ~ 600 V
Clamp opens to	40 mm
Frequency	0.1 Hz ~ 4000 Hz
Powered by	2x AA batteries
Resistance measurement	0.1 MΩ to 40 MΩ

SIN-400.3110

Amp clamp meter with voltmeter 30 mm



- Pocket sized
- CATIV 600V Probes
- 2 readings per second
- 4 digit LCD display
- Audible continuity check
- Data hold
- One touch auto zero
- Auto power off
- Low battery indicator



AC/DC Current	0.01 A ~ 400 A
AC/DC Voltage	0.001 V ~ 600 V
Clamp opens to	30 mm
Operating temperature	0°C ~ 50°C
Powered by	2x AA batteries
Resistance measurement	0.1 MΩ to 40 MΩ

SIN-112.0005

Automotive relay tester - SIN-112.0005



- Quickly and accurately test 3 terminal electro-mechanical relays used on most cars
- Suitable for a variety of applications including coil resistance, relay contacts and cyclic testing
- Colour-coded performance indicator



Coil test voltage	9 V
Contact resistance threshold	200 MΩ
Connect to	12 V battery or 24 V circuit (2x12 V batteries in serial)

HU-HU31017

Automotive relay tester



- Can test an entire circuit from the battery to the component in question
- Determine if the relay itself is functioning properly
- Instantly determine the problem within the circuit
- No need of a multimeter: just push the button
- Features easily accessible ports for use with other diagnostic tools for further diagnostic
- Can be used as a remote control starter in engine work like compression testing, distributor or cam shaft adjusting, to run the compressor etc.
- Compatible with 12 V and 24 V systems

Contents:

- 6 x Relay connectors
- Universal relay lead



VVD010

Auto circuit tester with LED display set 6 ~ 24 V



- Including a long probe (9 cm), a 12 V adapter, a hook-up clip
- Activating the components with positive or negative current



VVD011

Multi-functional auto circuit tester with LCD display 6 ~ 24 V



- Including a long probe (9 cm), a 12 V adapter, a hook-up clip
- Activating the components with positive or negative current



PPECT2000

Short & open circuit detector

Immediate detection and alerts ensure you know straight away whether a circuit is short or open. The detector comes with a transmitter, receiver and various adaptors to get you connected to any electrical circuit on a vehicle.

- Indicates direction to short
- Audible alert
- "Locks-in" a circuit signal and isolates it
- Capable of detecting signals through panels and carpets
- Locates battery drain problems
- Suitable for Canbus systems



PPBC101CS

Power Probe basic

- Activate electrical components
- Find short and open circuits
- Easily determine good & bad grounds
- Automatic circuit breaker reset



TABLE



	PP III	PPIV	Hook	PPBC101Cs
Adjustable Circuit Breaker			√	√
Circuit breaker	√	√		
Audible Monitoring	√			
Audio Tone		√	√	√
Voltage Drop detection		√	√	√
Headlights		√		
Continuity Tester	√	√	√	√
Hot Shot			√	√
4 mm Std banana Jacks	√	√	√	√
Powers up componants	√	√	√	√
Relay tester	√		√	√
Relay test		√	√	√
Short Circuit Indication	√	√	√	√
Smart Tip Technolgy			√	√
Voltage Ready	12 ~ 24 V DC	12 ~ 24 V DC	12 ~ 48 V DC	12 ~ 48 V DC
Voltage Reference		√	√	√
Amp Meter		√	√	√
Voltmeter	√	√	√	√
Ohm meter		√	√	√
Duty Cycle		√	√	√
Pulse Counter			√	√
Arc Detect			√	√
Dual Meter Mode			√	√
Switch Mode			√	√
Cranking Voltage	√	√	√	√

POWER TOOLS

AIR TOOLS

TOOL STORAGE

HAND TOOLS

WORKSHOP EQUIPMENT

SPECIALIST VEHICLE TOOLS

PP319FTC-RED

Power Probe III



- Probe - Connect - Detect!
- Continuity tester
- Jump lead
- Voltmeter
- +/- Voltage indicator
- Audible feature
- Bad ground indicator
- Lock-in indicator for instant recall
- Heavy-duty 4 mm keyed connectors



PP401AS

Power Probe IV



- Features AC/DC voltmeter, ohmmeter, frequency, pulse width (positive and negative) and additional diagnostic modes: fuel injector tester, PCM/ECM driver tester and ECT2000 signal tracer
- Supplies power and ground for functional component testing
- Digital volt and ohmmeter for circuit testing
- Large color LCD screen with easy to navigate user menu
- AC-RMS, AC peak to peak, frequency and pulse width for signal testing
- Fuel injector tester for easy circuit diagnosis
- PCM/ECM driver supplies safe voltage for testing computer driver circuits



PPH

Circuit tester/diagnostic tool



- **Activate high current drawing devices** - Up 100 Amps inrush current, 25 Amps constant
- **Adjustable current protection** - From 2 to 65 Amps
- **Voltage reference mode** - Supply 0.5 to 5 Volts/Computer safe 20 milliamps
- **Activate components** - Watch the current & internal resistance live automatically
- **Freedom** - To supply ground power - continuous, momentary or pulse, just set the Preference
- **Intermittent circuit testing** - With min/max modes for current, voltage and resistance you don't need to watch the screen to see what has happened in the circuit you are testing
- **Hot shot mode** - Load test power and grounds in 7 milliseconds. See a pass or fail result on the screen
- **Voltage drop** - The battery voltage is always displayed along with the voltage at the tip for comparison, you see the voltage drop just by looking at the display
- **Smart tip technology** - The hook will automatically select the ohm meter or volt meter and select the correct range for you
- **Module replacement** - What caused the module to go bad, is the new module at risk? With the module unplugged, the hook's current set at 2 Amps, we can now operate all the injectors, coils, relays and solenoids at the computer header safely. If you need more available current, just raise the circuit protection to match what you are testing.
- **Diesel glow plugs*** - Power up glow plugs and watch the current and resistance values live
- **Relay tester** - Just connect the relay test harness to the hook and see the result with the led's. Are the normally open & normally closed contacts good? Is the solenoid in the relay good?
- **Code diagnostics** - Scan tool gives the tech a circuit failure code. The hook can see any voltage drop and load the circuit with power or ground. The tech will see the current draw, internal resistance and the voltage in one test

- Suitable for use on systems upto 48 V, e.g. Forklift trucks
- Not for use on ceramic glow plugs or those under 5 V



PPLS01

Lead set

- Extend the reach of your Powerprobe with this lead set
- Superior 10 gauge multi-strand cables
- Supplied in a handy carrycase



PP3LS01

Lead set combo

- 10 gauge super flexible cables
- Standard 4 mm plugs and jacks
- The Power Probe III has a voltmeter and built-in banana jack for lead set accessories

Contents:

- Power Probe III
- Cigarette lighter adaptor
- 3" Probe tip
- Battery hook-up clips
- 20 ft Extension lead
- 2x Wire piercing probes
- Male to Female adaptors
- Alligator clip adaptor
- 1-3-6 ft Leads
- Instruction CD



PPKIT03

Power Probe master kit

A comprehensive kit ideal for the automotive professional

Contents:

- PP III (Power Probe)
- Leadset
- ECT2000 - Short and open circuit tester



POWER TOOLS

AIR TOOLS

TOOL STORAGE

HAND TOOLS

WORKSHOP EQUIPMENT

SPECIALIST VEHICLE TOOLS

SIN-400.31-SERIE

Probes, leads & croc-clips



SIN-400.3101	Universal probe leads (red & black)
SIN-400.3102	Cable piercing probe
SIN-400.3103	CAT III Probes (red & black)
SIN-400.3104	Needle back probe (red & black)
SIN-400.3105	Croc-clips (red & black)

SIN-400.3108

Universal automotive lead kit 10pc



- Double skin insulated silicone leads
- Highly heat resistant
- Bi-coloured layers for added safety

Contents:

- Test lead (red & black)
- Sharp steel spike probe (red & black)
- Heavy-duty cable piercer (red & black)
- Miniature back probe (red & black)
- Fully insulated crocodile clip (red & black)



SIN-400.3107

Test lead kit for probes 4pc



- Double skin insulated silicone leads
- Highly heat resistant
- Bi-coloured layers for added safety

Contents:

- Plug-to-plug extension lead
- Large back probe
- Heavy-duty cable piercer
- Fully insulated crocodile clip



SIN-110.2001

Universal ultra-fine back probe set



- Ultra-fine 0.7 mm needles - designed to cause minimal damage to seals and wires
- Nickered brass needles - able to bend, improving access in hard-to-reach areas
- Supplied in four colours
- Replaceable needles

Contents:

- 4x colour-coded probes
- 10x spare needles

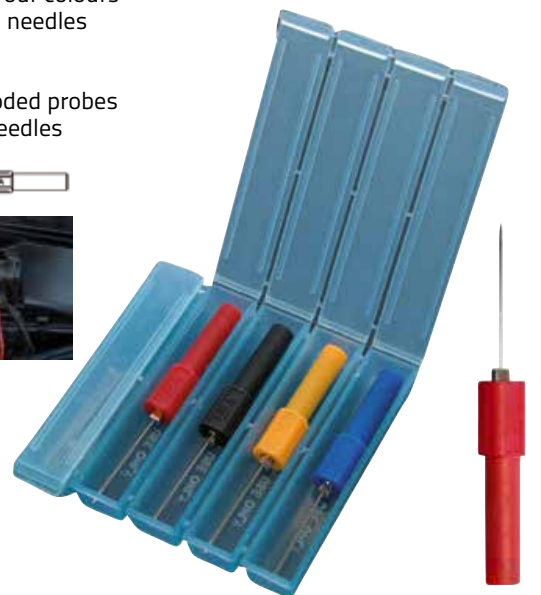

SIN-110.2001-1: 100x single needles

U-SIN-110.2002

Universal terminal set



- Micro adaptors - designed for easy retention on to plug-type connector terminals
- Ideal for a variety of automotive applications

Contents:

- 2x Male terminal crimp probes
- 2x Female terminal crimp probes



VVD005

Terminal release tool set 23pc



- Designed specifically for removing plug type connectors
- Quickly repair faults and corrosion
- Universal application

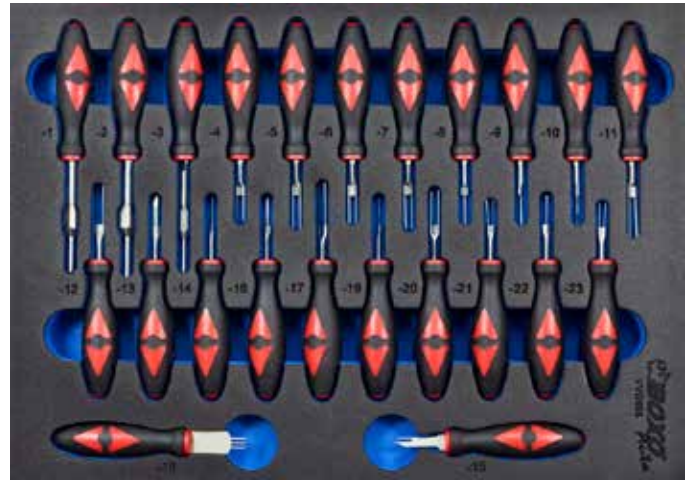

HU-AB70617

Multi meter



Functions:

- Volts AC/DC
- Current AC/DC
- Dwell
- Duty cycle
- Frequency
- Diode check
- RPM
- Temperature °C/°F
- Inductive clamp



HU-HU31010

Hybrid multimeter



Specially designed for hybrid cars, as well as all other automotive applications.

Functions:

- Volts AC/DC
- Current AC/DC
- Resistance
- RPM
- Frequency
- Dwell angle
- Duty cycle
- Diode check
- Temperature °C/°F
- Capacitance
- Continuity



POWER TOOLS

AIR TOOLS

TOOL STORAGE

HAND TOOLS

WORKSHOP EQUIPMENT

SPECIALIST VEHICLE TOOLS

HU-HUdT8861

Dual laser infrared thermometer



Dual laser sighting to keep the optimal distance from the target
 Automatic data hold
 °C/°F switch
 Emissivity adjustable from 0.10 to 1.0
 Max. temperature displays

Temperature range:
 -50°C ~ 550°C

Contents:

- 1x thermometer
- 1x 9 V battery
- 1x belt-mountable
- Carry case



HU-STE97215

Wireless electronic stethoscope set



Wireless ChassisEAR[®] with all the obvious resulting advantages especially when road testing.

Contents:

- 1x 4 Channel receiver
- 4x Transmitters
- 4x Sensor clamps

Applications

- Springs
- Shocks
- Brakes
- Body mounts
- Engine blocks etc.



INDEX BY ART. NR.

Art. Nr.	Page	Art. Nr.	Page	Art. Nr.	Page	Art. Nr.	Page	Art. Nr.	Page
13-16G	91	B-2211	187	B30914840	22	BX021	120	CUTF-R08	186
13-16I	74	B-2241	181	B309158	22	BX022A	117	CUTF-S08	186
A		B-2242	181	B30915840	22	BX024	117	CUTF-T08	186
AA0215	74	B-2243	181	BASIC-SET	106	BX025	118	CUTK-178	186
AB6200	80	B-2244	181	BC001	119	BX026	118	CUTK-B5	186
AB68001	87	B-3802	150	BD2710-500	171	BX027	119	CUTKI-06	196
AC20301	102	B-3803	150	BG-110	258	BX028	118	D	
AC7041M-G	65	B-3803-R	150	BG-CV88	260	BX029	113	D-ATB-154H	73
AC92333-B	80	B-3806R	129	BG-CV96	260	BX031	192	D-ATB-330M-154	73
ACB30041M	78	B-3812R	129	BG-CV96-12	260	BX032	113	D-ATB-330M-75H	73
ACB30041M-B	78	B-8015	168	BG-CV96TWINP	260	BX033	116	D-ATB-75H	73
ACB37041M-B	78	B-8015F	121	BG-DBC-8	262	BX034	118	D-ATB753M-154H	73
ACB745081M-B	78	B-AE-2TON	279	BG-DBC100	261	BX037	112	D-ATB753M-75H	73
AD20-038	147	B-AE-5TON	279	BG-DBC200	261	BX038	112	D-MST753M-154H	73
AD30-012	147	B-AE-7TON	279	BG-DBC300	261	BX039	113	D-MST753M-75H	73
AD30-014	147	B-AW0003	167	BG-DBC400	261	BX040	120	DD009-01	94
AD40-034	147	B-H1209R	130	BG-DBC500	261	BX041	116	DD009-01C	94
AD40-038	147	B-H3807R	129	BG-DBC600	261	BX042	116	DD009-10	94
AD60-012	147	B-HH0007	172	BG-DBC700	261	BX045	117	DD009A-14	94
ADI2030-001	60	B-HM0005	158	BG-DBC800	261	BX047	119	DD009A-15	94
ADI3020-001	60	B-HM0810	158	BG-DBSR100	263	BX051	116	DD009A-16	94
ADI3040-001	60	B-HM1113	158	BG-DBSR200	263	BX057	116	DU-1492	218
ADI4030-001	60	B-HM1214	158	BG-DBSR300	263	BX058	116	DU-1493	218
ADI4060-001	60	B-HM1315	158	BG-DBSR400	263	BX067A	116	DU-2212	218
ADI6040-001	60	B-HM1719	158	BG-DBSR500	263	BX073	121	DU-2244	218
ADI6080-001	60	B-HM1922	158	BG-DBSR600	263	BX074	117	DU-RJBKT	218
ADI8060-001	60	B-M0460	226	BG-DBSRPS100	264	BX076	117	DU-RJDBT2	216
AEN0098-18	185	B-M0480	226	BG-DBSRPS200	264	BX077	117	DU-RJDBT2L	217
AT7051M-G	66	B-M0900	226	BG-DBSRPS300	264	BX082	120	DU-RJPI	218
AT7071M-B	66	B-M1130	226	BG-DBSRST1	262	BX091	113	DU-RJPIV	218
AT7071M-G	66	B-PHR3	114	BG-FC1	260	BX092	113	DU-RJTBT2	216
AT7071M-R	66	B-S0008	155	BG-MC-1	260	BX093	113	DU-RJTBT2L	217
AT7072M-G	65	B-S1008	155	BG-MC-2	260	BX097	118	DU-RJTBT3	217
AT7081M-G	67	B-S1009	155	BH-UB414	264	BX098	118	DU-RJTBT3L	217
AT7091M-G	67	B-S1010	155	BH4281-1	174	BX1185-2	117	E	
ATB30051M-G	68	B-S1011	155	BH4281-2	174	BX128	114	ECC20301BK	102
ATB30071M-B	68	B-S1012	155	BH4281-3	174	BX212	114	EG-01-06-0012	43
ATB30071M-G	68	B-S1013	155	BH4281-4	174	BX340021	124	EG-BTOB15	47
ATB30071M-R	68	B-S1014	155	BH4281-5	174	BXC-025	171	EG01-009-0009	43
ATB30081M-G	69	B-S1015	155	BH4282-060	171	BXE013	105	EG01-3-C6-19R	40
ATB30091M-G	69	B-S1016	155	BSD-283000-RB	79	BXE179	104	EG01-C6-19R	40
ATB37071M-B	70	B-S1017	155	BT175	235	BXH20-F056	103	EG1060	39
ATB37081M-B	71	B-S1018	155	BT55	235	BXI-012	191	EG1062	39
ATB7450141M-B	71	B-S1019	155	BTD270071M-G	64	BXI-016	192	EG1062-2	48
ATR450131CL-B	72	B-SC0001	226	BTD340071M-G	64	BXI-S016	191	EG1062-3	48
ATR450131CL-BW	72	B-SD-BR08	173	BX000-1	95	BXI-S020	191	EG119M	46
AW6201	80	B-SD0038	173	BX000-3	95	BXM20-M15	122	EG120K-19R	37
AW6201A	80	B-SHR3	114	BX0015-2	112	BXP000-1	95	EG120ST	37
B		B-SLR3	114	BX002A	112	BXP000-2	95	EG125-19R	37
B-0008	157	B-SR0010	164	BX0025-2	112	BXP000-3	95	EG1460	29
B-0008-XL	157	B-T1209R	130	BX0035-2	112	BXP000-6	95	EG1662C	31
B-0018	154	B-T3808R	129	BX004A	120	BXP000-7	95	EG175HY	43
B-1202	150	B-TH0008	172	BX005	120	BXP000-8	95	EG178	39
B-1202-R	150	B-TJ30T	219	BX005A	120	BXP000-9	95	EG195	44
B-1203	150	B-TJLR15	219	BX005TA	120	BXS004	113	EG19CF	50
B-1203-R	150	B-TR08	128	BX006	116	BXS005	113	EG21036-2	46
B-1205R	130	B-XLF0006	162	BX0065-2	117	BXZ11-02	76	EG210K-19R	37
B-1209R	131	B-XLFH0809	162	BX0075-2	117	BXZ11-03	76	EG213-19R	36
B-1402	150	B-XLFH1011	162	BX009	118	BXZ11-03S	76	EG225-19R	36
B-1402-R	150	B-XLFH1213	162	BX010	118	BXZ11-04	75	EG2260E	42
B-1403	150	B-XLFH1415	162	BX011	118	C		EG2460	28
B-1403-R	150	B-XLFH1618	162	BX012	120	C1011018	23	EG2480	28
B-1407R	128	B-XLFH1719	162	BX013	119	C1031038	23	EG250-19R	38
B-1438R	128	B002	74	BX014	119	C1081358	23	EG255A	38
B-2202	187	B30111820	22	BX015A	113	C1121358	23	EG2560	29
B-2203	187	B303138	22	BX016	112	CUTCS-205	195	EG26036-7	47
B-2204	188	B30313820	22	BX017	112	CUTES-138	187	EG2605-19R	42
B-2206	188	B308148	22	BX019	116	CUTF-F08	186	EG280	41
B-2208	187	B309148	22	BX020	120	CUTF-HR08	186	EG280CK-6	41

Art. Nr.	Page
EG280K-6	41
EG307008-K01A	49
EG307008-K02A	48
EG307008-K02B	48
EG307008-K02C	48
EG307008-K02D	48
EG307008-K03A	49
EG307008-K04A	48
EG307008-K05A	49
EG307008-K06A	49
EG307008-K07A	49
EG307008-K08A	48
EG308	43
EG317043	50
EG317043A	50
EG317043B	50
EG32-1484	50
EG32-1488	48
EG32-1489	48
EG32-1490	48
EG32-1491	49
EG32-1492	47
EG32-1493	50
EG320	43
EG327B-TC1	46
EG327BH-65K	46
EG327BH-80K	46
EG327HN	36
EG552	32
EG553	32
EG554A	35
EG554B	35
EG557A	30
EG557B	30
EG561A	33
EG561B	33
EG6062	43
EG6062-14	50
EG663	31
EG671CF	42
EG672CF	42
EG700	34
EG702A	40
EG702A001	46
EG705	34
EG707	40
EG7070007	46
EG805	38
EG910	51
EG915	51
EG954	50
EGBEZD3018A	46
EGBEZD3024A	46
EGBEZD3032A	46
EGBT-ADPT	47
EGBT246655	47
EGBTWW103-235	47
EGBTWW103-2355	47
EGBTWW103-237	47
EGD001021060	50
EGD001031060	39
EGPF2001	46
EGSTBT246652	47
EX2040-050	148
EX2040-050M	149
EX2040-075	148
EX2040-100	148
EX2040-150	148
EX3040-045M	149

Art. Nr.	Page
EX3040-050	148
EX3040-075	148
EX3040-075M	149
EX3040-150	148
EX3040-250	148
EX4040-050	148
EX4040-050M	149
EX4040-075	148
EX4040-075M	149
EX4040-125	148
EX4040-150	148
EX4040-250	148
EX4040-600	148
EXECUTIVE-SET	108
EXI20050-001	60
EXI20100-001	60
EXI20150-001	60
EXI30075-001	60
EXI30150-001	60
EXI30250-001	60
EXI40075-001	60
EXI40125-001	60
EXI40200-001	60
EXI40250-001	60
EXI60100-001	60
EXI60150-001	60
EXI60175-001	60
EXI60200-001	60
EXI60250-001	60
EXI60330-001	60
EXI60400-001	60
EXI80100-001	60
EXI80175-001	60
EXI80200-001	60
EXI80250-001	60
EXI80330-001	60
EXI80400-001	60
F	
F6201	80
G	
GJ-COV5	225
GJ007R	45
GJ0465	225
GJ0465-6	225
GJ2006-B4N	225
GJ2006-B56N	225
GJ2006-B6N	225
GJ4100L	224
GJ4100R	224
GJ4500	223
GJ5000	222
GJ6200L	222
GJ6200R	222
GJ7016	223
GJGOBKT	225
GJGOTOW	225
GJHS-2020	49
GJQS-12	49
GJQS9000R	44
GWADS20	148
GWADS30	148
GWADS40	148
GWFO-008	161
GWFO-009	161
GWFO-010	161
GWFO-011	161
GWFO-012	161
GWFO-013	161
GWFO-014	161

Art. Nr.	Page
GWFO-015	161
GWFO-016	161
GWFO-017	161
GWFO-018	161
GWFO-019	161
GWFO-12B	161
GWNRO-008	163
GWNRO-009	163
GWNRO-010	163
GWNRO-011	163
GWNRO-012	163
GWNRO-013	163
GWNRO-014	163
GWNRO-015	163
GWNRO-016	163
GWNRO-017	163
GWNRO-018	163
GWNRO-019	163
GWNRO-12B	163
GWNRO-4CB	163
GWRO-008	164
GWRO-009	164
GWRO-010	164
GWRO-011	164
GWRO-012	164
GWRO-013	164
GWRO-014	164
GWRO-015	164
GWRO-016	164
GWRO-017	164
GWRO-018	164
GWRO-019	164
GWRO-12B	164
GWRO-4CB	164
GW50-0608	159
GW50-1012	159
GW50-1418	159
GW50-2024	159
H	
HBI4600H-004	57
HBI4600H-005	57
HBI4600H-006	57
HBI4600H-007	57
HBI4600H-008	57
HBI4600H-009	57
HBI4600H-010	57
HBI4600H-011	57
HBI4600H-012	57
HBI4600H-013	57
HBI4600H-014	57
HBI4600H-015	57
HBI4600H-016	57
HBI4600H-017	57
HBI4600H-018	57
HBI4600H-019	57
HBI4600T-020	56
HBI4600T-025	56
HBI4600T-027	56
HBI4600T-030	56
HBI4600T-040	56
HBI4600T-045	56
HBI4600T-050	56
HBI4600T-055	56
HBI4600T-060	56
HBI4600T-070	56
HBI4678M-014	57
HBI4678M-016	57
HBI4678M-018	57
HBSC2610	148

Art. Nr.	Page
HBSC3610S	148
HBSC4610S	148
HBSHM	171
HM7010-1000	181
HM7010-300	181
HM7010-400	181
HM7010-500	181
HM7010-600	181
HM7010-800	181
HM7011-016	181
HM7110-035	181
HM7110-035RK	181
HM7850-035	181
HM7850-045	181
HM7850-055	181
HM7850-065	181
HS-300H	188
HS-300J	188
HU-AB70586	278
HU-AB70617	295
HU-AB70880	273
HU-AB70897	264
HU-AB70899	277
HU-AB70906B	277
HU-AB70908B	277
HU-AB70950	264
HU-AB70961	277
HU-AB70993	276
HU-AB71180	285
HU-HU12007	278
HU-HU12012	278
HU-HU12015	284
HU-HU13002	274
HU-HU14001	250
HU-HU14002	247
HU-HU14005	247
HU-HU31010	295
HU-HU31017	290
HU-HU31019	288
HU-HU33003	250
HU-HU35005	272
HU-HU41005	272
HU-HU41008	272
HU-HU41034	272
HU-HU414	274
HU-HU44016	246
HU-HU46008	283
HU-HU46009	283
HU-HU46011	283
HU-HU46012	283
HU-HUCF02	289
HU-HUCF02S	289
HU-HUCF08	289
HU-HUDT8861	296
HU-HUS202	257
HU-HUS210	271
HU-HUS309A	190
HU-MI6403	284
HU-MI6413	284
HU-MI7201	284
HU-STE97215	296
I	
INC100	239
IT-19X20	196
L	
LED-002	174
M	
M25101138	20
M25101138-K2	20

Art. Nr.	Page
M25701138	20
M25701138-K2	20
M25901238	14
M25901238-K2	14
M25902238	14
M25902238-K2	14
M26102138	11
M26102138-K2	11
M26304138	12
M26304138-K2	12
M26601138	13
M26601138-K2	13
M26702138	12
M26702138-K2	12
M26801138	8
M26801138-K2	8
MAA003	74
MAA008	74
MAA011A	74
MAA013	109
MAA021	74
MAA025	74
MAA034	74
MET-0076	126
MET-0106	153
MET-0107	153
MET-0110	153
MET-0125	153
MET-0135	153
MET-0220	128
MET-0230	128
MET-0300	124
MET-0320	128
MET-0321	128
MET-0325	122
MET-0330	128
MET-0331	128
MET-0427	123
MET-0430	130
MET-0431	130
MET-0440	130
MET-0441	130
MET-0450	124
MET-0559	126
MET-0563	127
MET-0625	125
MET-0650	125
MET-1108	153
MET-1109	153
MET-1110	153
MET-1111	153
MET-1112	153
MET-1113	153
MET-1114	153
MET-1115	153
MET-1116	153
MET-1117	153
MET-1118	153
MET-1119	153
MET-1120	153
MET-1122	153
MET-1124	153
MET-1126	153
MET-1129	153
MET-1132	153
MET-1210	140
MET-1211	140
MET-1212	140
MET-1213	140

Art. Nr.	Page
MET-1214	140
MET-1215	140
MET-1216	140
MET-1217	140
MET-1218	140
MET-1219	140
MET-1220	140
MET-1222	140
MET-1223	140
MET-1224	140
MET-1225	140
MET-1226	140
MET-1228	140
MET-1229	140
MET-1231	140
MET-1250	141
MET-1251	141
MET-1252	141
MET-1253	141
MET-1254	141
MET-1255	141
MET-1256	141
MET-1257	141
MET-1258	141
MET-1259	141
MET-1260	141
MET-1262	141
MET-1263	141
MET-1264	141
MET-1265	141
MET-1267	141
MET-1268	141
MET-1270	141
MET-1272	141
MET-1287	148
MET-1288	149
MET-1290	123
MET-1291	148
MET-1292	147
MET-1293	147
MET-1294	149
MET-1295	125
MET-1296	148
MET-1297	148
MET-1298	147
MET-1299	149
MET-1308	137
MET-1309	137
MET-1310	137
MET-1311	137
MET-1312	137
MET-1313	137
MET-1314	137
MET-1315	137
MET-1316	137
MET-1317	137
MET-1318	137
MET-1319	137
MET-1320	137
MET-1322	137
MET-1350	137
MET-1351	137
MET-1352	137
MET-1353	137
MET-1354	137
MET-1355	137
MET-1356	137
MET-1357	137
MET-1358	137

Art. Nr.	Page
MET-1359	137
MET-1360	137
MET-1362	137
MET-1387	148
MET-1388	149
MET-1390	125
MET-1391	148
MET-1392	149
MET-1393	148
MET-1394	148
MET-1395	147
MET-1396	147
MET-1397	149
MET-1398	149
MET-1399	149
MET-1404	134
MET-1405	134
MET-1406	134
MET-1407	134
MET-1408	134
MET-1409	134
MET-1410	134
MET-1411	134
MET-1412	134
MET-1413	134
MET-1454	134
MET-1455	134
MET-1456	134
MET-1457	134
MET-1458	134
MET-1459	134
MET-1460	134
MET-1461	134
MET-1462	134
MET-1463	134
MET-1488	148
MET-1490	150
MET-1490SN	150
MET-1491	150
MET-1492	148
MET-1493	148
MET-1494	147
MET-1495	149
MET-1496	148
MET-1497	149
MET-1498	148
MET-1499	149
MET-2210	54
MET-2211	54
MET-2212	54
MET-2213	54
MET-2214	54
MET-2215	54
MET-2216	54
MET-2217	54
MET-2218	54
MET-2219	54
MET-2220	54
MET-2221	54
MET-2222	54
MET-2223	54
MET-2224	54
MET-2225	54
MET-2227	54
MET-2228	54
MET-2230	54
MET-2232	54
MET-2250	55
MET-2251	55

Art. Nr.	Page
MET-2252	55
MET-2253	55
MET-2254	55
MET-2255	55
MET-2256	55
MET-2257	55
MET-2258	55
MET-2259	55
MET-2260	55
MET-2261	55
MET-2262	55
MET-2263	55
MET-2264	55
MET-2265	55
MET-2267	55
MET-2268	55
MET-2270	55
MET-2272	55
MET-2310	52
MET-2311	52
MET-2312	52
MET-2313	52
MET-2314	52
MET-2315	52
MET-2316	52
MET-2317	52
MET-2318	52
MET-2319	52
MET-2320	52
MET-2321	52
MET-2322	52
MET-2350	53
MET-2351	53
MET-2352	53
MET-2353	53
MET-2354	53
MET-2355	53
MET-2356	53
MET-2357	53
MET-2358	53
MET-2359	53
MET-2360	53
MET-2361	53
MET-2362	53
MS101	96
MS102	96
MS103	97
MS104W	96
MS105	97
MS106	97
MS107	98
MS108	98
MS109	98
MS110	99
MS111W	99
MS112W	99
MS113	100
MSC340001	87
MSF005-03	89
MSF005-11	89
MSF005-14A	89
MSF005-15A	89
MSN002	87
MSN002-1	87
MSN002-3	87
MSN002-4-1	87
MSN002-4-2	87
MSN002P	87
MSN002S	87

Art. Nr.	Page
MSN003-M	88
MSN003-RL	88
MSN003S-M	88
MSN003S-RL	88
MSN004-230V	87
MSN005-03C	89
MSN005-11C	89
MSN005-14A	89
MSN005-15A	89
MSN007-2	88
MSN008-2	88
MSN011-2	88
MSS005-03A	89
MSS005-11A	89
MSS005-14A	89
MSS005-15A	89
MST110F	100
MST111	100
MST112	101
MST113W	101
MST240001	86
MST260072	85
MST30001A	86
MST340001	84
MST340011	85
MST340021	84
MST340051	84
MST340071	85
MST340072	85
MST340081	85
MST340091	84
MST3400AGW	86
MST3400S11	87
MST341021	85
MST341031	84
MST44001	86
MST9012-1	86
MST9012-230V	87
MT-FG	189
MT-PC	189
MT-PR200	189
MT-SDE	186
MT-SP	186
MT-SPGM	188
MT-SPGS	188
MT-SR	189
MT-VC	189
MT50019	189
MT80025	189
N	
NI4304	29
O	
OBD-L	239
P	
P-52PS	76
P-52PUF	76
P-52PUS	76
P-52TF	76
P-AR-C12	131
P-AR-C14	131
P-AR-C38	131
P-AR160	132
P-AR215	132
P-AR305	132
P-KEYLOCK-C-N1	75
P-KEYLOCK-D-N1	92
P-MST-01	90
P-MST-02	90
P-MST-03	90

Art. Nr.	Page
P-MST-04	90
P-MST-05	90
P-MST-06	90
P-MST-06-01	91
P-MST-07	90
P-MST-08A	89
P-MST-08WA	89
P-MST-09	90
P-MST-09A	90
P-OSM-24H	91
P-OSM-44H	91
P-OSM-AGW	91
P-OSM-BB-24	91
P-OSM-BB-34	91
P-OSM-BB-44	91
P-OSM-SBF	92
P-OSM-SBF-02	92
P-OSM-SBF-03	92
P-OSM-SBF-04	92
P-OSM-SBL	91
P-TDH-20	75
P-TDH-40	75
P-TOPMA-AT70	77
P-TOPPV-ATB37	77
P-TOPPV-ATB45	77
P-TOPPV-ATR45	77
P-TOPTR-AT70	77
P-TOPTR-ATB30	77
P-TOPWVO-ATR45	77
P-TSH-20	75
P-TSH-40	75
PC2811-2115	185
PC2811-3125	185
PC2811-4150	185
PC2811-5165	185
PC2811-6180	185
PC2811-8180	185
PC2821-3120	185
PC2821-4120	185
PC2821-5120	185
PC2821-6120	185
PC2831-1014	185
PC2831-1215	185
PC2831-1618	185
PC2831-1818	185
PC2831-2220	185
PC2841-2120	185
PC2851-5130	185
PC2861-0004-1	185
PH-10052	17
PH-10136	16
PH-10147	16
PH-10261	24
PH-10507	16
PH-10546	24
PH-10606	24
PH-10714	16
PH-10722	15
PH-3510	287
PH-415-SET	214
PH-430-SET	215
PH-BFT-14	267
PH-BFT-2	267
PH-BFT-25	267
PH-BFT-26	267
PH-BFT-316	267
PH-BFT-475	267
PH-BFT-5	267
PH-BFT-6	267

Art. Nr.	Page	Art. Nr.	Page	Art. Nr.	Page	Art. Nr.	Page	Art. Nr.	Page
PH-FLEXI-KERA	214	PS-7450-0006	233	SB20-PZ237	136	SB40-SL1055	145	SCW1631-45150	170
PH-FLEXI800	214	PS-7450-0008	233	SB20-PZ337	136	SB40-SL1255	145	SCW1631-50175	170
PH-IND415	214	PS-7453-0008	233	SB20-SL0337	136	SB40-T1055	143	SCW1641-00075	170
PH-IND419	214	PS-7454-0005	232	SB20-SL0437	136	SB40-T1555	143	SCW1641-01100	170
PH-IND420	214	PS-7454-0006	232	SB20-SL0637	136	SB40-T20100	143	SCW1641-02100	170
PH-IND423	214	PS-750LIL	230	SB20-SL0837	136	SB40-T2055	143	SCW1641-03150	170
PH-IND426	214	PS-7601-0004	232	SB20-SL4537	136	SB40-T25100	143	SCW6100-0050	169
PH-IND432	214	PS-7700-0019	234	SB20-SL5537	136	SB40-T2555	143	SCW6100-0150	169
PH-IND438	214	PS-7700-0021	234	SB20-T0837	135	SB40-T27100	143	SCW6100-050	169
PH-IND445	214	PS-7700-0040	234	SB20-T1037	135	SB40-T2755	143	SCW6200-1550	169
PH-MAT-4SET	226	PS-775LI	231	SB20-T1537	135	SB40-T30100	143	SCW6200-2050	169
PH-REMOVAL	214	PS-800E	228	SB20-T2037	135	SB40-T3055	143	SCW6200-3050	169
PH-SPOT-KERA	214	PS-JL353	234	SB20-T2537	135	SB40-T40100	143	SCWA-7CB	168
PP-05BP	184	PS-JL353SP	234	SB20-T2737	135	SB40-T40138	143	SCWAT-7CB	168
PP-06-1MP	184	PS-JL355	234	SB20-T3037	135	SB40-T4055	143	SCWT	194
PP-06-5MP	184	PS-JL355SP	234	SB20-T4037	135	SB40-T45100	143	SCWT-L690V	194
PP06BP	184	PS-JLSP	234	SB30-H0348	139	SB40-T4555	143	SCWV-6CB	191
PP319FTC-RED	292	PS-K703K710	232	SB30-H0448	139	SB40-T50100	143	SCWV-7CB	191
PP3LS01	293	PS-LI600	230	SB30-H0548	139	SB40-T5055	143	SH2400-150	149
PP401AS	292	PS-LI600-9	232	SB30-H0648	139	SB40-T55100	143	SIN-100.0035-1	211
PPBC101CS	291	PS-OBDI	232	SB30-H0748	139	SB40-T55138	143	SIN-100.0035-2	211
PPCT	288	PS-SP1224	235	SB30-H0848	139	SB40-T5555	143	SIN-100.0035-6	211
PPECT2000	291	PS-TROLLEY	231	SB30-H1048	139	SB40-T60100	143	SIN-100.0035-7	211
PPH	292	PU-112085	255	SB30-PH148	139	SB40-T6055	143	SIN-100.1009	204
PPKIT03	293	PU-112086	186	SB30-PH248	139	SB40-T70100	143	SIN-100.1010	204
PPLS01	293	PU-112087	257	SB30-PH348	139	SB40-T7055	143	SIN-100.1010R	204
PPMT	213	PU-112088	257	SB30-PZ148	140	SB40-TP3055	144	SIN-100.1010Y	204
PPSK	213	PU-115270	255	SB30-PZ248	140	SB40-TP4055	144	SIN-100.1019	208
PR-AC1-0852	182	PU-115271	255	SB30-PZ348	140	SB40-TP4555	144	SIN-100.1026-2	211
PR-AC2-0852	182	PU-115327	255	SB30-SL0848	140	SB40-TP5055	144	SIN-100.1030	209
PR-AC3-0852	182	PU-115328	255	SB30-SL1048	140	SB40-TP5555	144	SIN-100.1045	206
PR-AC4-0852	182	PU-115329N	255	SB30-SL5548	140	SB40-TP6055	144	SIN-100.1060	207
PR-AC5-0852	182	PU-115990	254	SB30-SL6548	140	SBT	235	SIN-100.1060-1	212
PR6510I-006	195	PU-115991	254	SB30-T1548	139	SBT-PAPER	235	SIN-100.1060-2	212
PR6520-008	179	PU-115993N	257	SB30-T2048	139	SCI90	238	SIN-100.1060-5	212
PR6520I-008	195	PU-115994N	257	SB30-T2548	139	SCW-006PB	168	SIN-100.1060-7	212
PR6530-007	177	PU-115996N	257	SB30-T2748	139	SCW1610-05100	170	SIN-100.1061	212
PR6530I-007	195	PU-115999	256	SB30-T3048	139	SCW1610-06100	170	SIN-100.1062	212
PR6540-010	175	R		SB30-T4048	139	SCW1610-08150	170	SIN-100.1063	212
PR6550-007	195	RS1420-272	151	SB30-T4548	139	SCW1610-95200	170	SIN-100.1064	212
PR6550I-007	195	RS1430-272	151	SB30-T5048	139	SCW1611-03075	169	SIN-100.1065	212
PR6560I-008	195	RS1440-272	151	SB30-T5548	139	SCW1611-03100V	194	SIN-100.1070	207
PR6570I-006	196	RS4310-036	151	SB40-H0455	144	SCW1611-04100	169	SIN-100.1070-2	211
PR6630-005	183	RS61D2-148	151	SB40-H05138	144	SCW1611-04100V	194	SIN-100.1075	210
PR6630-007	183	RS6211-072	151	SB40-H0555	144	SCW1611-06038	169	SIN-100.2001BR	208
PR6630-010	183	RS6211-124	151	SB40-H06100	144	SCW1611-06100	169	SIN-100.2010	203
PR6640-006	183	RS6211-124RK	151	SB40-H0655	144	SCW1611-08150	169	SIN-100.2020	202
PR6640-009	183	RS8211-124	151	SB40-H07100	144	SCW1611-55125V	194	SIN-100.2026	205
PR6710-007E	180	RSR272R	151	SB40-H0755	144	SCW1611-65150V	194	SIN-100.2026-B	205
PR6710-007I	180	RSR372R	151	SB40-H08100	144	SCW1611-95200	169	SIN-100.2026-O	205
PR6720-007E	180	RSR472R	151	SB40-H0855	144	SCW1620-01100	170	SIN-100.2026-R	205
PR6720-007I	180	S		SB40-H0955	144	SCW1620-02100	170	SIN-100.2026-Y	205
PRCCI-011	196	SB20-H0337	135	SB40-H10100	144	SCW1620-03150	170	SIN-100.2030	202
PREMIUM-SET	107	SB20-H0437	135	SB40-H1055	144	SCW1621-00060V	194	SIN-100.2040	209
PRL-45	179	SB20-H0537	135	SB40-H1255	144	SCW1621-00075	169	SIN-110.2001	294
PRL-90	179	SB20-H0637	135	SB40-H1455	144	SCW1621-01080V	194	SIN-110.2001-1	294
PRL-ST	179	SB20-H0737	135	SB40-H1755	144	SCW1621-01100	169	SIN-112.0005	290
PRM-B	177	SB20-H0837	135	SB40-H1955	144	SCW1621-02038	169	SIN-160.0004	268
PRM-C	177	SB20-H2537	135	SB40-M06100	144	SCW1621-02100	169	SIN-160.0004-L	269
PRM-D	177	SB20-M0537	135	SB40-M0655	144	SCW1621-02100V	194	SIN-160.0004-R	269
PRM-L	177	SB20-M0637	135	SB40-M08100	144	SCW1621-03150	169	SIN-160.0005	268
PS-1224E	228	SB20-M0837	135	SB40-M0855	144	SCW1631-08075	170	SIN-160.0010	269
PS-1224HD-E	228	SB20-PH037	136	SB40-M10100	144	SCW1631-10075	170	SIN-170.0010	267
PS-24HD-E	228	SB20-PH137	136	SB40-M1055	144	SCW1631-15075	170	SIN-170.0017	251
PS-510E	227	SB20-PH237	136	SB40-M12100	144	SCW1631-20075	170	SIN-170.0019	251
PS-700EL	227	SB20-PH337	136	SB40-M1255	144	SCW1631-25100	170	SIN-170.0021	251
PS-7450-0001	233	SB20-PH437	136	SB40-M14100	144	SCW1631-27100	170	SIN-170.0022	251
PS-7450-0002	233	SB20-PZ037	136	SB40-M1455	144	SCW1631-30100	170	SIN-171.1011	162
PS-7450-0004	233	SB20-PZ137	136	SB40-SL0855	145	SCW1631-40125	170	SIN-171.1214	162

Art. Nr.	Page
SIN-171.1315	162
SIN-171.1618	162
SIN-171.1719	162
SIN-171.2021	162
SIN-171.2224	162
SIN-250.0006	282
SIN-250.0007	282
SIN-300.0015	185
SIN-300.0021	249
SIN-300.0030	186
SIN-300.0040	249
SIN-300.2010	44
SIN-400.3101	294
SIN-400.3102	294
SIN-400.3103	294
SIN-400.3104	294
SIN-400.3105	294
SIN-400.3107	294
SIN-400.3108	294
SIN-400.3110	289
SIN-400.3511	289
SIN-401.0001	259
SIN-401.0002	259
SIN-401.0003	259
SIN-401.0004	259
SIN-401.0005	259
SIN-401.0006	259
SIN-401.0010	274
SIN-401.0015	274
SIN-401.0020	274
SIN-500.0012	10
SIN-500.0019	10
SIN-500.0125	24
SIN-500.0195	24
SIN-500.0196	24
SIN-500.0801A	24
SIN-604.0001	278
SIN-900.0405	197
SIN-900.0410	197
SIN-900.0415	197
SIN-900.0500	272
SIN-900.0501	282
SIN-900.0504	282
SIN-900.0560	286
SK2060-004	134
SK2060-004E	135
SK2060-004L	134
SK2060-005	134
SK2060-005E	135
SK2060-005L	134
SK2060-006	134
SK2060-006E	135
SK2060-006L	134
SK2060-007	134
SK2060-007E	135
SK2060-007L	134
SK2060-008	134
SK2060-008E	135
SK2060-008L	134
SK2060-009	134
SK2060-009L	134
SK2060-010	134
SK2060-010E	135
SK2060-010L	134
SK2060-011	134
SK2060-011E	135
SK2060-011L	134
SK2060-012	134
SK2060-012L	134

Art. Nr.	Page
SK2060-013	134
SK2060-013L	134
SK2060-014	134
SK2060-014L	134
SK2060-045	134
SK2060-045L	134
SK2060-055	134
SK2060-055L	134
SK2060-13AR	128
SK2060L-13AR	128
SK3060-004E	138
SK3060-005E	138
SK3060-006	137
SK3060-006E	138
SK3060-006L	137
SK3060-007	137
SK3060-007E	138
SK3060-007L	137
SK3060-008	137
SK3060-008E	138
SK3060-008L	137
SK3060-009	137
SK3060-009L	137
SK3060-010	137
SK3060-010E	138
SK3060-010L	137
SK3060-011	137
SK3060-011E	138
SK3060-011L	137
SK3060-012	137
SK3060-012E	138
SK3060-012L	137
SK3060-013	137
SK3060-013L	137
SK3060-014	137
SK3060-014E	138
SK3060-014L	137
SK3060-015	137
SK3060-015L	137
SK3060-016	137
SK3060-016L	137
SK3060-017	137
SK3060-017L	137
SK3060-018	137
SK3060-018L	137
SK3060-019	137
SK3060-019L	137
SK3060-020	137
SK3060-020L	137
SK3060-021	137
SK3060-021L	137
SK3060-022	137
SK3060-022L	137
SK3060-024	137
SK3060-024L	137
SK3060-13AR	129
SK3060L-13AR	129
SK3122-006	138
SK3122-007	138
SK3122-008	138
SK3122-009	138
SK3122-010	138
SK3122-010L	138
SK3122-011	138
SK3122-011L	138
SK3122-012	138
SK3122-013	138
SK3122-013L	138
SK3122-014	138

Art. Nr.	Page
SK3122-015	138
SK3122-016	138
SK3122-017	138
SK3122-018	138
SK3122-019	138
SK3122-020	138
SK3122-021	138
SK3122-022	138
SK4060-008	141
SK4060-008L	142
SK4060-009	141
SK4060-009L	142
SK4060-010	141
SK4060-010E	143
SK4060-010L	142
SK4060-011	141
SK4060-011E	143
SK4060-011L	142
SK4060-012	141
SK4060-012E	143
SK4060-012L	142
SK4060-013	141
SK4060-013L	142
SK4060-014	141
SK4060-014E	143
SK4060-014L	142
SK4060-015	141
SK4060-015L	142
SK4060-016	141
SK4060-016E	143
SK4060-016L	142
SK4060-017	141
SK4060-017L	142
SK4060-018	141
SK4060-018E	143
SK4060-018L	142
SK4060-019	141
SK4060-019L	142
SK4060-020	141
SK4060-020E	143
SK4060-020L	142
SK4060-021	141
SK4060-021L	142
SK4060-022	141
SK4060-022L	142
SK4060-023	141
SK4060-023L	142
SK4060-024	141
SK4060-024E	143
SK4060-024L	142
SK4060-025	141
SK4060-025L	142
SK4060-026	141
SK4060-026L	142
SK4060-027	141
SK4060-027L	142
SK4060-028	141
SK4060-028L	142
SK4060-029	141
SK4060-029L	142
SK4060-030	141
SK4060-030L	142
SK4060-032	141
SK4060-032L	142
SK4060-034	141
SK4060-11AR	130
SK4060L-11AR	130
SK4122-008	142
SK4122-009	142

Art. Nr.	Page
SK4122-010	142
SK4122-011	142
SK4122-012	142
SK4122-013	142
SK4122-014	142
SK4122-015	142
SK4122-016	142
SK4122-017	142
SK4122-018	142
SK4122-019	142
SK4122-020	142
SK4122-021	142
SK4122-022	142
SK4122-023	142
SK4122-024	142
SK4122-026	142
SK4122-027	142
SK4122-030	142
SK4122-032	142
SK4122-034	142
SK6061-019	146
SK6061-021	146
SK6061-022	146
SK6061-023	146
SK6061-024	146
SK6061-026	146
SK6061-027	146
SK6061-028	146
SK6061-029	146
SK6061-030	146
SK6061-032	146
SK6061-033	146
SK6061-034	146
SK6061-035	146
SK6061-036	146
SK6061-038	146
SK6061-041	146
SK6061-046	146
SK6061-050	146
SK6061-055	146
SK6061-060	146
SK6122-019	146
SK6122-022	146
SK6122-024	146
SK6122-027	146
SK6122-030	146
SK6122-032	146
SK6122-036	146
SK6122-038	146
SK6122-041	146
SK6122-046	146
SK6122-050	146
SK6122-055	146
SKI3060-005E	53
SKI3060-006	52
SKI3060-006E	53
SKI3060-006L	53
SKI3060-007	52
SKI3060-007E	53
SKI3060-007L	53
SKI3060-008	52
SKI3060-008E	53
SKI3060-008L	53
SKI3060-009L	53
SKI3060-010	52
SKI3060-010E	53
SKI3060-011	53
SKI3060-011E	53
SKI3060-011L	53
SKI3060-012	53
SKI3060-012E	53
SKI3060-012L	53
SKI3060-013	53
SKI3060-013L	53
SKI3060-014	53
SKI3060-014E	53
SKI3060-014L	53
SKI3060-015	53
SKI3060-015L	53
SKI3060-016	53
SKI3060-016E	53
SKI3060-016L	53
SKI3060-017	53
SKI3060-017L	53
SKI3060-018	53
SKI3060-018E	53
SKI3060-018L	53
SKI3060-019	53
SKI3060-019L	53
SKI3060-020	53
SKI3060-020E	53
SKI3060-020L	53
SKI3060-021	53
SKI3060-021L	53
SKI3060-022	53
SKI3060-022E	53
SKI3060-022L	53
SKI3060-023	53
SKI3060-023L	53
SKI3060-024	53
SKI3060-024E	53
SKI3060-024L	53

Art. Nr.	Page
SKI3060-011E	53
SKI3060-011L	53
SKI3060-012	52
SKI3060-012E	53
SKI3060-012L	53
SKI3060-013	52
SKI3060-013L	53
SKI3060-014	52
SKI3060-014E	53
SKI3060-014L	53
SKI3060-015	52
SKI3060-015L	53
SKI3060-016	52
SKI3060-016E	53
SKI3060-016L	53
SKI3060-017	52
SKI3060-017L	53
SKI3060-018	52
SKI3060-018L	53
SKI3060-019	52
SKI3060-019L	53
SKI3060-020	52
SKI3060-020L	53
SKI3060-021	52
SKI3060-021L	53
SKI3060-022	52
SKI3060-022L	53
SKI4060-008	54
SKI4060-008L	55
SKI4060-009	54
SKI4060-009L	55
SKI4060-010	54
SKI4060-010E	56
SKI4060-010L	55
SKI4060-011	54
SKI4060-011E	56
SKI4060-011L	55
SKI4060-012	54
SKI4060-012E	56
SKI4060-012L	55
SKI4060-013	54
SKI4060-013L	55
SKI4060-014	54
SKI4060-014E	56
SKI4060-014L	55
SKI4060-015	54
SKI4060-015L	55
SKI4060-016	54
SKI4060-016E	56
SKI4060-016L	55
SKI4060-017	54
SKI4060-017L	55
SKI4060-018	54
SKI4060-018E	56
SKI4060-018L	55
SKI4060-019	54
SKI4060-019L	55
SKI4060-020	54
SKI4060-020E	56
SKI4060-020L	55
SKI4060-021	54
SKI4060-021L	55
SKI4060-022	54
SKI4060-022E	56
SKI4060-022L	55
SKI4060-023	54
SKI4060-023L	55
SKI4060-024	54
SKI4060-024E	56
SKI4060-024L	55

POWER TOOLS

AIR TOOLS

TOOL STORAGE

HAND TOOLS

WORKSHOP EQUIPMENT

SPECIALIST VEHICLE TOOLS

Art. Nr.	Page
SKI4060-024L	55
SKI4060-025	54
SKI4060-025L	55
SKI4060-026	54
SKI4060-026L	55
SKI4060-027	54
SKI4060-027L	55
SKI4060-028	54
SKI4060-028L	55
SKI4060-029	54
SKI4060-029L	55
SKI4060-030	54
SKI4060-030L	55
SKI4060-032	54
SKI4060-032L	55
SKI6060-019	58
SKI6060-019L	58
SKI6060-021	58
SKI6060-021L	58
SKI6060-022	58
SKI6060-022L	58
SKI6060-024	58
SKI6060-024L	58
SKI6060-027	58
SKI6060-027L	58
SKI6060-028	58
SKI6060-028L	58
SKI6060-030	58
SKI6060-030L	58
SKI6060-032	58
SKI6060-032L	58
SKI6060-033	58
SKI6060-033L	58
SKI6060-034	58
SKI6060-034L	58
SKI6060-036	58
SKI6060-036L	58
SKI8060-024	59
SKI8060-024L	59
SKI8060-027	59
SKI8060-027L	59
SKI8060-030	59
SKI8060-030L	59
SKI8060-032	59
SKI8060-032L	59
SKI8060-033	59
SKI8060-033L	59
SKI8060-034	59
SKI8060-036	59
SKI8060-036L	59
SKI8060-041	59
SKI8060-041L	59
SKI8060-046	59
SKI8060-046L	59
SKI8060-050	59
SKI8060-055	59
SKI8060-060	59
SKIN406A-15	57
SKIN406A-17	57
SKIN406A-19	57
SKIN406A-21	57
SKIN406A-22	57
SP3120-014	147
SP3600-016	147
SP3600-016M	147
SP3600-018	147
SP3600-021	147
SP3600-021M	147
SP4600-016	147

Art. Nr.	Page
SP4600-016M	147
SP4600-021	147
SP4600-021M	147
SPI1	236
SPI10	237
SPI1024V	238
SPI15	238
SPI2	236
SPI3	237
SPI6	237
STARTER-SET	106
STB2100-115	149
STB3100-165	149
STB3100-200	149
STB4100-250	149
STB4100-300	149
STB6100-450	149
SW4410-380	150
SW4410-460	150
SW4712-600	150
SWT7311-014	257
SWT7311-020	257
SWT7311-024	257
T	
T65805238-K	17
T65805238-K2	17
T65805338-K	17
T65805338-K2	17
T65806218-K	16
T65806218-K2	16
T65806318-K	16
T65806318-K2	16
T75101458-K	21
T75101458-K2	21
T75501158-K	15
T75501158-K2	15
T75701158-K	21
T75701158-K2	21
T75804248-K	18
T75804248-K2	18
T75804348-K	18
T75804348-K2	18
T76201158-K	11
T76201158-K2	11
T76802258-K	8
T76802258-K2A	8
T76811158-K	9
T76811158-K2	9
T76811358-K	9
T76811358-K2	9
TB-ECC30030-B	79
TB-ECC30030-BL	79
TB-ECC30030-R	79
TB003	103
TEX4040-090	251
TEX4040-100	251
TEX4040-110	251
TEX4040-120	251
TEX4040-135	251
TEX4040-150	251
TEX4040-160	251
TEX4040-175	251
TEX4040-190	251
TEX4040-200	251
TWM2-1000N	152
TWM2-100N	152
TWM2-1500N	152
TWM2-200N	152
TWM2-320N	152

Art. Nr.	Page
TWM2-60N	152
TWM2-800N	152
TWR-M3	152
TWR-M4	152
TWR-M6	152
TWR-M8	152
TWR-M8A	152
U	
U-BX120030	123
U-BX140052	122
U-BX14120122	127
U-BX380036	123
U-BX1-033	192
U-BX1-038	192
U-BX1-044	192
U-M25602138	13
U-MET-2300	51
U-MET-2305	51
U-MET-2400	51
U-MET-2450	51
U-MET-2460	251
U-PR9110-228	285
U-PR9110-305	285
U-PR9110-394	285
U-PR9210-241	180
U-PR9510-152	178
U-PR9511-152	176
U-PR9511-178	176
U-PR9520-152	178
U-PR9520-203	179
U-PR9521-200	178
U-PR9530-152	178
U-PR9531-190	175
U-PR9540-165	175
U-PR9540-203	175
U-PR9540-241	175
U-PR9540-254	175
U-PR9540-305	175
U-PR9540-419	175
U-PR9540-514	175
U-PR9541-241	175
U-PR9542-241	175
U-PR9550-242	176
U-PR9560-146	179
U-PR9590-158	177
U-SIN-110.2002	295
U-SIN-170.0006	162
U-SIN-170.0020	251
U-SIN-170.0100	162
U-SIN-170.0120	162
U-SIN-200.0005	190
U-SIN-300.0035	246
U-SIN-300.0045	240
U-SIN-300.0046	240
U-SIN-300.0047	240
U-SIN-406.0005	240
U-SIN-900.0535	285
U-SIN-900.0540	285
U-SIN-900.0550	283
U-SIN-900.0551	283
U-SIN-900.0552	283
U-SIN-900.0553	283
U-SIN-900.0554	283
U-SIN-900.0555	283
UJ2300-001	148
UJ2300-001M	148
UJ3300-001	148
UJ3300-001M	148
UJ4300-001	148

Art. Nr.	Page
UJ4300-001M	148
UJI2300-001	60
UJI3300-001	60
UJI4300-001	60
UJI6300-001	60
UJI8300-001	60
USIN-100.00192	211
V	
VB003-8	269
VB003-9	269
VB416	271
VD013-13	248
VD416	248
VD423	249
VD424	249
VD429	288
VD478	246
VE423	285
VE424	285
VE473	190
VE476	274
VG415	185
VP002-1	266
VVA001	252
VVA002	252
VVA003	280
VVA005	252
VVA006	280
VVA008	280
VVB001	270
VVB003	271
VVB004	270
VVB005	271
VVB006	270
VVC003	276
VVC006	276
VVD002	248
VVD005	295
VVD006	235
VVD010	290
VVD011	290
VVD012	247
VVD014	249
VVD015	279
VVD020	248
VVE001	286
VVE002	286
VVE003	286
VVE005	275
VVE007	276
VVE008	275
VVE011	275
VVE012	272
VVE019	273
VVE034	282
VVE035	275
VVE039	275
VVE040	271
VVE041	273
VVE044	276
VVE045	276
VVE046	286
VVE047	286
VVE051	115
VVE052	115
VVE053	115
VVG002	252
VVG003	273
VVG004	265

Art. Nr.	Page
VVG005	287
VVP001	265
VVP002	266
VVP003	266
VVP005	266
VVP006	265
VVR004	280
VVR006	281
VVR007	281
VVS002	281
VVS003	281
VVS005	252
W	
WHK2501-009	172
WHK2501T-009	172
WHK2501TP-009	172
WHK2511-009	172
WHK2511BP-009	172
WHK2511T-009	172
WHK2511TP-009	172
WHK2521-009	172
WHK2521BP-009	172
WHK2521T-009	172
WHK2521TP-009	172
WHKAT22H-009	173
WR1013I-010	194
WR1513-004	167
WR1513-006	167
WR1513-008	167
WR1513-010	167
WR1513-012	167
WR1513-015	167
WR1523-018	167
WR1523-024	167
WR1710-006	154
WR1710-007	154
WR1710-008	154
WR1710-009	154
WR1710-010	154
WR1710-011	154
WR1710-012	154
WR1710-013	154
WR1710-014	154
WR1710-015	154
WR1710-016	154
WR1710-017	154
WR1710-018	154
WR1710-019	154
WR1710-020	154
WR1710-021	154
WR1710-022	154
WR1710-023	154
WR1710-024	154
WR1710-025	154
WR1710-026	154
WR1710-027	154
WR1710-028	154
WR1710-029	154
WR1710-030	154
WR1710-032	154
WR1710-034	154
WR1710-036	154
WR1710-03B	154
WR1710-041	154
WR1710-046	154
WR1710-050	154
WR1710-12B	154
WR1710-16B	154
WR1720-0607	156

SERENCO



serious tools > serious results

Maarssebroeksedijk 39,
3542 DM Utrecht,
Nederland
Postbus 40353,
3504 AD Utrecht, Nederland

T +31 (0)30 241 50 11
F +31 (0)30 241 50 46
E info@serenco.nl
I www.serenco.nl



serious tools > serious results