



# Assembly Solutions

Solutions d'Assemblage  
Montagelösungen  
Soluciones de Montaje  
Soluzioni per l'Assemblaggio



Technical Specifications  
Caractéristiques Techniques  
Technische Daten  
Especificaciones  
Caratteristiche



Edition 4.1

# Technical Symbols

Symboles Techniques  
Technische Symbole  
Símbolos Técnicos  
Simboli tecnici

Assembly Tools

Outils d'Assemblage

Montagewerkzeuge

Herramientas de Montaje

Utensili per l'Assemblaggio

## Note Nota Anmerkung

This catalogue is designed in 5 languages. In order to simplify it, all technical information is represented by symbols. In the event of difficulty of interpretation, please refer to the following list to know the exact significance.

Ce catalogue a été conçu pour un accès en 5 langues. Afin d'en simplifier la lisibilité, toutes les informations techniques sont signalisées par des symboles. En cas de difficulté d'interprétation, vous pouvez consulter la liste ci-contre pour connaître leur signification exacte.

Dieser Katalog umfasst 5 Sprachen. Zur Vereinfachung werden alle technischen Informationen mit Unterstützung von Symbolen dargestellt. Zum besseren Verständnis der Symbole finden Sie nachfolgend eine entsprechende Erläuterung.

Este catálogo fue concebido para un acceso en 5 idiomas. A fin de simplificar la legibilidad, todas las informaciones técnicas son señalizadas por símbolos. En caso de dificultad de interpretación, puede consultar la lista siguiente para conocer su significación exacta.

Questo catalogo è predisposto per la consultazione in 5 lingue. Per semplificarne la lettura, tutte le informazioni tecniche sono state rappresentate da simboli. In caso di difficoltà incontrate nella loro interpretazione, consultare la lista a fronte per conoscerne l'esatto significato.

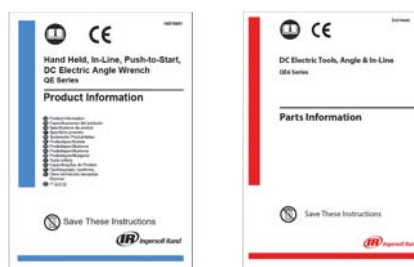

Product informations, maintenance manuals and part manuals of the products described in this catalogue are available on [www.irtechpubs.com](http://www.irtechpubs.com).

Les fiches techniques, les manuels de maintenance et listes de pièces détachées des produits présentés dans ce catalogue sont disponibles sur [www.irtechpubs.com](http://www.irtechpubs.com).

Produkt-Informationen, Wartung und Ersatzteile finden Sie auf [www.irtechpubs.com](http://www.irtechpubs.com).

Información sobre el producto, manual de mantenimiento y piezas de los productos descritos en este catálogo están disponibles en [www.irtechpubs.com](http://www.irtechpubs.com).

Las informaciones sobre los productos, los manuales de mantenimiento y piezas de los productos descritos en este catálogo están disponibles en [www.irtechpubs.com](http://www.irtechpubs.com).

Le informazioni sui prodotti, i manuali di manutenzione e parti di ricambio dei prodotti presentati in questo catalogo sono disponibili sul sito [www.irtechpubs.com](http://www.irtechpubs.com).



Air tools  
Outils pneumatiques  
Druckluftbetriebene Werkzeuge  
Herramientas neumáticas  
Utensili pneumatici



Electric tools  
Outils électriques  
Gleichstrombetriebene Werkzeuge  
Herramientas eléctricas  
Utensili elettrici



Fastening  
Vissage  
Verschrauben  
Herramientas de montaje  
Avvitare



Drilling  
Perçage  
Bohren  
Taladrado  
Forare



Tapping  
Tarudage  
Gewinde schneiden  
Roscado  
Filettare



Riveting  
Rivetage  
Vernieten  
Remachado  
Rivettare



Material handling  
Manutention  
Handhabungsgeräte  
Manutención  
Materiale di sollevamento



Reversible models  
Modèles réversibles  
Umsteuerbar  
Modelos reversibles  
Modelli reversibili



Non reversible models  
Modèles non réversibles  
Nicht umsteuerbar  
Modelos no reversibles  
Modelli non reversibili



Torque range  
Plage de couple utile  
Drehmomentbereich  
Gamma de par  
Campo di coppia

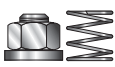

Torque range with light clutch spring  
Plage de couple utile avec ressort d'embrayage faible  
Drehmomentbereich mit weicher Kupplungsfeder  
Gama de par con muelle de embrague ligero  
Campo di coppia con molla leggera

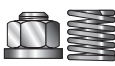

Torque range with heavy clutch spring  
Plage de couple utile avec ressort d'embrayage fort  
Drehmomentbereich mit harter Kupplungsfeder  
Gama de par con muelle de embrague fuerte  
Campo di coppia con molla pesante



Max. free speed  
Vitesse maxi. à vide  
Freie Drehzahl  
Velocidad libre  
Velocità libera massima



Bolt capacity  
Capacité de boulon  
Empfohlene Schraubengröße  
Gama tamaño perno  
Capacità bullone



Stall torque  
Couple de calage  
Maximales Drehmoment  
Par de ahogo  
Coppia di stallo



Max. chuck / collet capacity  
Capacité maxi. du mandrin ou de la pince  
Spannzangen / Bohrfutterkapazität  
Capacidad portabrocas / pinza  
Capacità mandrino / pinza massima



Blows per minute  
Nombre de coups par minute  
Schlagzahl  
Golpes por minuto  
Colpi al minuto



Tool weight  
Poids de l'outil  
Gewicht des Werkzeugs  
Peso de la herramienta  
Peso dell'utensile

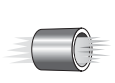

Max. air consumption  
Consommation d'air maxi.  
Max. Luftverbrauch  
Consumo de aire máx.  
Massimo consumo d'aria



Connection thread  
Filetage de connexion  
Anschlußgewinde  
Rosca de conexión  
Attacco filettato

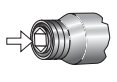

Bit holder  
Porte lame ou embout  
Klingenhalter  
Portapuntas  
Porta punta



Bit holder or square drive  
Type d'entraîneur  
Klingenhalter oder Antriebsvierkant  
Eje de accionamiento  
Porta punta o attacco quadro



Spindle thread  
Filetage de la broche  
Spindelgewinde  
Rosca del eje  
Filettatura albero

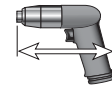

Tool length  
Longueur de l'outil  
Länge des Werkzeugs  
Longitud de la herramienta  
Lunghezza dell'utensile

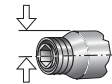

Side to centre distance  
Distance axe / paroi  
Werkzeugradius am Abtrieb  
Distancia centro / lado  
Ingombro laterale

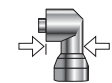

Angle head height  
Hauteur tête d'angle  
Winkelkopfhöhe  
Altura cabeza angular  
Altezza testa ad angolo

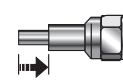

Inline floating spindle stroke  
Course de la broche télescopique  
Gleitspindelhub  
Recorrido flotante del eje  
Corsa albero telescopico

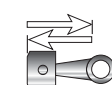

Piston stroke  
Course du piston  
Kolbenhub  
Carrera del pistón  
Corsa del pistone



Nominal load capacity  
Capacité de charge nominale  
Max. Traglast  
Carga nominal  
Capacità nominale del carico



Standard height of lift  
Hauteur de levée standard  
Standardhubhöhe  
Altura de elevación  
Corsa standard



Lifting speed at rated load  
Vitesse de levage à la charge nominale  
Geschwindigkeit bei Nennlast / beim Heben  
Velocidad de elevación con carga nominal  
Velocità di salita con carico nominale



Lifting speed without load  
Vitesse de levage à vide  
Max. Geschwindigkeit ohne Last / beim Heben  
Velocidad de elevación sin carga  
Velocità di salita senza carico



1/4" Hex quick change (for power bits)  
Mandrin rapide 1/4" hex. (pour lames)  
1/4" Skt. Schnellwechselfutter (für Klingen)  
Cambio rápido 1/4" hex (para puntas)  
Portapunte a cambio rapido da 1/4" ex.



1/4" Hex bit holder (for power bits only)  
Entraîneur 1/4" hex. (pour embouts de 25 mm)  
1/4" Skt. Klingenhalter (nur für Klingen)  
Portapuntas 1/4" hex (sólo para puntas)  
Portapunte da 1/4" ex. (sólo per punte)



1/4" Hex insert bit holder (for 25 mm insert bit)  
Entraîneur 1/4" hex. (pour embouts de 25 mm)  
1/4" Skt. Klingenhalter (für 25 mm Einsteck-Klingen)  
Portapuntas 1/4" hex para puntas cortas (25 mm)  
Portainseriti da 1/4" ex. (per inserti da 25 mm)



1/4" Hex bit holder (requires bit guide or finder)  
Entraîneur 1/4" hex. (pour montage avec coiffe)  
1/4" Skt. Klingenhalter (Klingen-Führungshülse erforderlich)  
Portapuntas 1/4" hex (requiere guía de punta o centrador)  
Portapunte da 1/4" ex. (richiede guida punta o ricercatore)



Square drive  
Entraîneur carré  
Vierkant-Antriebsspindel  
Cuadrado de salida  
Albero quadro



Sound level  
Niveau sonore  
Geräuschpegel  
Nivel de ruido  
Livello sonoro



Tool air inlet connection  
Entrée d'air de l'outil  
Anschlußgewinde des Werkzeugs  
Entrada de aire  
Attacco ingresso aria dell'utensile

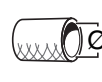

Hose min. internal diameter  
Diamètre intérieur mini. du tuyau d'alimentation  
Empfohlene Schlauchweite  
Tamaño mín. de manguera  
Minimo diametro int. tubo gomma



Rated power  
Puissance nominale  
Nennleistung  
Potencia nominal  
Potenza nominale

**Ingersoll Rand Assembly Solutions**  
**Solutions d'Assemblage Ingersoll Rand**  
**Ingersoll Rand Montagelösungen**  
**Soluciones de Montaje Ingersoll Rand**  
**Soluzioni per l'Assemblaggio Ingersoll Rand**

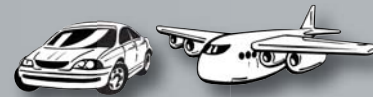

**Automotive & motorcycles**      **Aeronautics**

<b>Air Tools</b> <b>Outils pneumatiques</b> <b>Druckluftwerkzeuge</b> <b>Herramientas neumáticas</b> <b>Utensili pneumatici</b>	Light Assembly Tools Outils d'assemblage légers Leichte Montagewerkzeuge Ligero montaje herramientas Leggero montaggio utensili	<b>1 Series</b>	<b>Q2 Series</b>		
	Medium & Heavy Assembly Tools Outils d'assemblage moyens et lourds Mittlere und schwere Montagewerkzeuge Intermedio y constantemente montaje herramientas Medie e forte montaggio utensili	<b>41 Series</b>	<b>5 to 9 Series</b>		
	Air pulse Nutrunners / Screwdrivers Clés hydro-pneumatiques Impulsschrauber Aprietuercas y atornilladores de impulso Chiavi ad impulso idraulico e cacciaviti		<b>Power Pulse</b>		
	Precision Fastening Tools Visseuses de précision Präzisions-Abschalterschrauber Llaves de precisión Avvitatori di precisione	<b>LD BALD</b>	<b>QA Series</b>		
	Production Drills Perceuses de production Bohrmaschinen für Industrieinsatz Taladros para producción Trapani per produzione	<b>1 &amp; Q2 Series</b>	<b>5 to 7 Series</b>		
	Precision Drills Perceuses de précision Präzisions-Bohrmaschinen Taladros de precisión Trapani di precisione		<b>P33 Series</b>		
	Tappers, Riveters, Sanders Taraudeuses, riveurs, polisseuses Gewindeschneidmaschinen, Niethämmer, Schmirgelmaschinen Roscadoras, remachadores, lijadoras Filettrici, martelli ribaditori, levigatrici		<b>Special Tools</b>		
	Air Tool Accessories Accessoires pour outils pneumatiques Zubehör für Druckluftwerkzeuge Accesorios para herramientas neumáticas Accessori per utensili pneumatici				
<b>Electric Tools</b> <b>Outils électriques</b> <b>Gleichstrombetriebene Werkzeuge</b> <b>Herramientas eléctricas</b> <b>Utensili elettrici</b>	Light Assembly Tools Outils pour assemblage léger Leichte Montagewerkzeuge Ligero montaje herramientas Leggero montaggio utensili		<b>VersaTec Series</b>		
	Precision Fastening Tools Visseuses de précision Gesteuerte EC-Schrauber Llaves de precisión Avvitatori di precisione	<b>QE Series</b>	<b>QM Series</b>		
<b>Ergonomic Systems</b> <b>Systèmes ergonomiques</b> <b>Ergonomische Handhabungstechnik</b> <b>Sistemas ergonómicos</b> <b>Sistemi ergonomici</b>	Torque Arms Bras anti-réaction Drehmomentstützen Bracci pneumatici Brazos neumáticos		<b>QTA Series</b>		
	Ergonomic Handling Systems Systèmes de Manutention Ergonomiques Ergonomische Handhabungstechnik Sistemas de Manipulación Ergonomicos Sistemi di Manutenzione Ergonomica		<b>ERGO Products</b>		

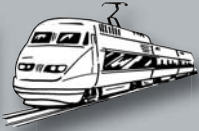

Agriculture & Trucks

White Goods

Railways

Wood Industry & Manufacturing

Industrial Manufacturing

Nautics

Plastics, Toys

Electrics & Electronics

Medical & Precision Material



1

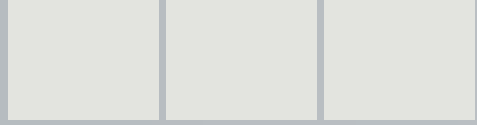

2

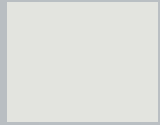
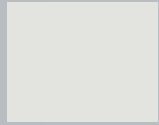
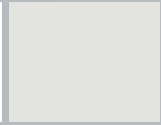
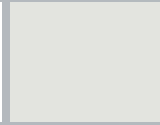
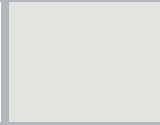

3

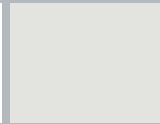

4

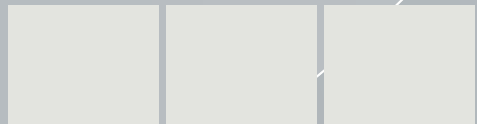

5

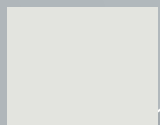
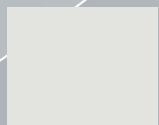
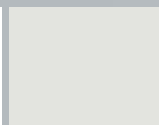

6

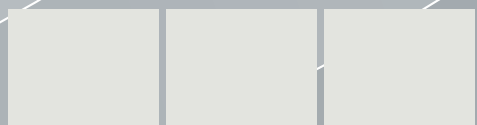
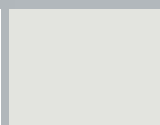

7



8

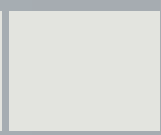
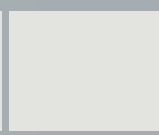
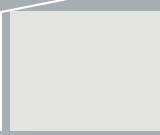
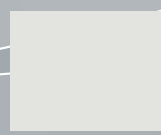

9

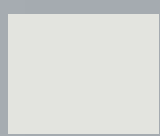
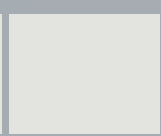
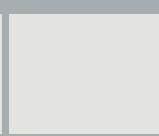
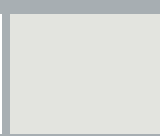

10



11

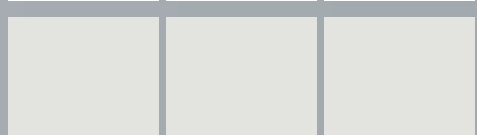

12

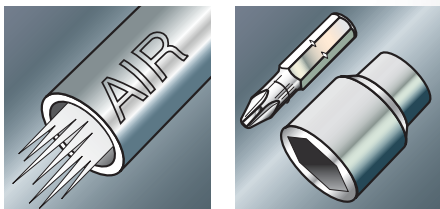

# Air Fastening Tools

*Outils d'Assemblage Pneumatiques  
Druckluftbetriebene Montagewerkzeuge  
Herramientas de Montaje Neumáticas  
Utensili Pneumatici per l'Assemblaggio*

10

**1  
Series**

Light Assembly Tools  
Outils d'assemblage légers  
Leichte Montagewerkzeuge  
Ligero montaje herramientas  
Leggero montaggio utensili

12

**Q2  
Series**

Light Assembly Tools  
Outils d'assemblage légers  
Leichte Montagewerkzeuge  
Ligero montaje herramientas  
Leggero montaggio utensili

18

**41  
Series**

Medium & Heavy Assembly Tools  
Outils d'assemblage moyens et lourds  
Mittlere und schwere Montagewerkzeuge  
Intermedio y constantemente montaje herramientas  
Medie e forte montaggio utensili

21

**5 to 9  
Series**

Medium & Heavy Assembly Tools  
Outils d'assemblage moyens et lourds  
Mittlere und schwere Montagewerkzeuge  
Intermedio y constantemente montaje herramientas  
Medie e forte montaggio utensili

23

**LD  
BALD**

Precision Fastening Tools  
Visseuses de précision  
Präzisions-Abschalterschrauber  
Llaves de precisión  
Avvitatori di precisione

26

**QA  
Series**

Precision Fastening Tools  
Visseuses de précision  
Präzisions-Abschalterschrauber  
Llaves de precisión  
Avvitatori di precisione

29

**Power  
Pulse**

Air pulse Nutrunners / Screwdrivers  
Clés hydro-pneumatiques  
Impulsschrauber  
Aprietueras y atomilladores de impulso  
Chiavi ad impulso idraulico e cacciaviti



# Air Assembly Tools Torque Ranges

## Gammes de couple des outils d'assemblage pneumatiques

## Drehmomentbereich der Druckluft-Montagewerkzeuge

## Gama de par herramientas de montaje neumáticas

## Campo di coppia degli utensili pneumatici per l'assemblaggio

	0	1 Nm	5 Nm	10 Nm	20 Nm	50 Nm	100 Nm	200 Nm	300 Nm
<b>1 Series</b>	Adjustable clutch — Limiteur de couple réglable Einstellbare Kupplung — Embrague ajustable — Frizione regolabile								
	Direct drive — Entraînement direct — Direktantrieb Accionamiento directo — Trasmissione diretta								
<b>Q2 Series</b>	Adjustable clutch — Limiteur de couple réglable Einstellbare Kupplung — Embrague ajustable — Frizione regolabile								
	Direct drive — Entraînement direct — Direktantrieb Accionamiento directo — Trasmissione diretta								
<b>41 Series</b>	Adjustable clutch — Limiteur de couple réglable Einstellbare Kupplung — Embrague ajustable — Frizione regolabile								
	Direct drive — Entraînement direct — Direktantrieb Accionamiento directo — Trasmissione diretta								
<b>5 to 9 Series</b>	Adjustable clutch — Limiteur de couple réglable Einstellbare Kupplung — Embrague ajustable — Frizione regolabile								
	Direct drive — Entraînement direct — Direktantrieb Accionamiento directo — Trasmissione diretta								
<b>QA Series</b>	Adjustable clutch — Limiteur de couple réglable Einstellbare Kupplung — Embrague ajustable — Frizione regolabile								
	Direct drive — Entraînement direct — Direktantrieb Accionamiento directo — Trasmissione diretta								
<b>LD BALD</b>	Adjustable clutch — Limiteur de couple réglable Einstellbare Kupplung — Embrague ajustable — Frizione regolabile								
	Direct drive — Entraînement direct — Direktantrieb Accionamiento directo — Trasmissione diretta								
<b>Power Pulse</b>	Shut-off — A coupure d'air automatique — Mit Abschaltventil — Con parada automática — con valvola di blocco								
	Non shut-off — Sans coupure d'air automatique — Ohne Abschaltventil Sin parada automática — Senza valvola di blocco								

ISO 9001 Certifications  
 Certifications ISO 9001  
 ISO 9001 zertifiziert  
 Certificación ISO 9001  
 Certificazione ISO 9001



# Clutch selection / Types of joints

## Sélection de l'embrayage / Types d'assemblages

### Auswahl der Kupplung / Schraubverbindungen

### Selección del embrague / Tipos de juntas

### Selezione della Frizione / Tipo di giunto

#### Adjustable Precision Shut-Off Clutch

#### Embrayage réglable à coupure d'air

#### Einstellbare auto. Abschaltkupplung

#### Embrague ajustable de parada automática

#### Frizione regolabile con blocco aria

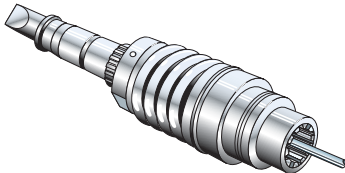

Designed for critical fastening operations involving plastics, composites or metals. Recommended for applications that require precise torque control. Automatic shut-off reduces air consumption. Torque settings can easily be adjusted without disassembly of the tool.

Embrayage pour assemblages nécessitant un couple précis. L'arrêt automatique avec coupure d'air améliore la précision du serrage et réduit la consommation d'air. Réglage extérieur du couple, rapide et sans démontage de l'outil.

Konstruiert für kritische Verschraubungen in Kunststoff, Verbundwerkstoffe und Metall. Besonders geeignet für drehmomentgenaue Präzisionverschraubungen. Durch automatische Abschaltung wird der Luftverbrauch reduziert. Drehmomenteinstellung erfolgt problemlos ohne Demontage des Werkzeuges.

Diseñado para aplicaciones de ajustes críticos en plásticos o metales. Recomendado en aplicaciones que requieran control de par preciso. La válvula shut-off, reduce el consumo de aire. La tuerca de fijación se puede ajustar fácilmente sin desmontar la herramienta.

Realizzata per avvitiamenti critici su plastica, materiali compositi o metalli. Raccomandata per applicazioni che richiedono un preciso controllo della coppia. Questo tipo di frizione riduce i consumi aria. La regolazione della coppia può essere effettuata senza smontare l'attrezzo.

#### Adjustable Cushion Clutch

#### Embrayage réglable à billes

#### Einstellbare Rutschkupplung

#### Embrague ajustable deslizante

#### Frizione regolabile a cuscono

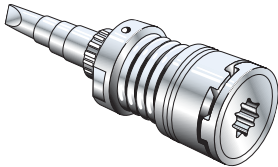

An excellent general purpose clutch. The Cushion Clutch Mechanism features up to 24 steel balls which provide a smooth rolling action that improves torque control, increases clutch life and minimises vibration to the operator and work piece.

Excellent pour la plupart des assemblages. Embrayage assurant un entraînement sans friction. Améliore la qualité du serrage, tout en diminuant l'usure et les vibrations. Réglage extérieur du couple, rapide et sans démontage de l'outil.

Die ideale Kupplung für allgemeine Verschraubungen. Die 24 Stahlkugeln des Kupplungsmechanismus gewährleisten exakte Drehmomentkontrolle, erhöhen die Standzeit der Kupplung und reduzieren Vibrationen auf Werkstück und Bediener erheblich.

Excelente embrague para trabajos en general. El mecanismo de embrague de colchón consta de 24 bolas de acero que proporciona una acción de rodaje suave e incrementa el control de par, prolonga la vida del embrague y minimiza las vibraciones al operario y a la pieza de trabajo.

Eccellente per qualsiasi tipo di applicazione. Il meccanismo della frizione incorpora 24 sfere che forniscono un'azione di trascinamento che migliora il controllo di coppia, prolunga la durata della frizione e minimizza le vibrazioni all'operatore e al pezzo.

#### Positive Jaw Clutch

#### Embrayage à clabots

#### Nicht einstellbare Klauenkupplung

#### Embrague positif

#### Frizione a ganasce oblique

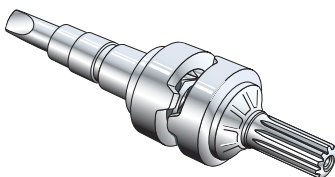

Designed for applications where driving torque may exceed final seating torque. Recommended for wood and self tapping applications where torque requirements vary. Applied torque is controlled by the operator and output of the motor; torque output may be limited by regulating air line pressure.

Conçu pour les applications où le couple d'entraînement de la vis peut dépasser le couple de serrage final. Embrayage particulièrement recommandé pour pose de vis à bois et vis autotaraudeuses impliquant des résistances variables au cours du vissage. Le couple appliqué est en fonction de la poussée exercée sur la visseuse et du couple de calage moteur, celui-ci étant réglable par la pression d'air.

Ausgelegt für Verschraubungen, bei denen das Anzugsdrehmoment das statische Enddrehmoment überschreiten kann. Besonders geeignet für Holz- und selbstschneidende Schrauben, bei denen unterschiedliche Drehmomente auftreten können. Das Anzugsdrehmoment wird vom Bediener über den Anpreßdruck gesteuert; das Abgabedrehmoment kann durch einen Druckregler begrenzt werden.

Diseñado para aplicaciones donde el par transmitido puede exceder al par prefijado. Recomendado para tornillos madera y autoroscado donde haya una resistencia variable. El par aplicado es controlado por el operario y por la potencia del motor; el par debe ser ajustado mediante la regulación de la presión de aire de la red.

Realizzata per applicazioni in cui la coppia iniziale può essere superiore a quella finale. Raccomandata per applicazioni su legno e per viti autofilettanti dove la coppia richiesta è variabile. La coppia applicata viene controllata dall'operatore e dalla potenza del motore; la coppia sviluppata può essere limitata regolando la pressione di alimentazione.

#### Direct Drive

#### Entraînement direct

#### Direktantrieb

#### Accionamiento directo

#### Trasmissione diretta

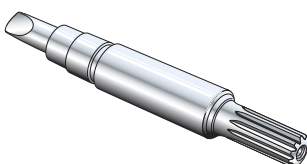

Designed for soft pull applications in wood and other materials not requiring critical torque control. Applied torque is controlled by the operator and output of the motor; torque output may be limited by regulating air line pressure.

Bon pour assemblages élastiques à faible couple et ne nécessitant pas de précision de serrage. Le couple appliqué correspond au couple de calage moteur, et dépend donc de la pression d'air.

Besonders geeignet für weiche Verschraubungen in Holz oder anderen Materialien, bei denen keine hohe Drehmomentgenauigkeit erforderlich ist. Das Anzugsdrehmoment wird vom Bediener gesteuert; das Abgabedrehmoment kann über einen Druckregler begrenzt werden.

Diseñado para aplicaciones de impulso suave en madera y otros materiales donde no sea crítico el par requerido. El par es controlado por el operario y la potencia del motor; el par debe ser ajustado mediante la regulación de la presión de aire de la red.

Realizzata per applicazioni elastiche su legno e altri materiali che non richiedono controllo di coppia critico. La coppia applicata viene controllata dall'operatore e dalla potenza del motore; la coppia sviluppata può essere limitata regolando la pressione di alimentazione.



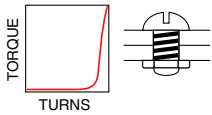

**Free running-slam:** Resistance low at start and during rundown but peaks suddenly as bolt head seats.

**Serrage franc:** Faible résistance jusqu'au contact, puis montée en couple très rapide.

**Freidrehende Schrauben:** Geringer Widerstand beim Einschrauben, der beim Aufsitzen der Schraube plötzlich steil ansteigt.

**Carrera libre:** Baja resistencia al principio y durante la carrera pero se incrementa fuertemente cuando el tornillo llega a su asiento.

**Corsa libera:** La bassa resistenza alla partenza e durante l'avvicinamento rapidamente aumenta a fine corsa.

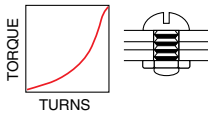

**Compression gaskets:** Turning resistance gradually increases as squeeze progresses to final turn.

**Serrage élastique:** Résistance avec montée en couple progressives jusqu'au serrage final.

**Weiche Schraubverbindungen:** Drehwiderstand steigt beim Zusammenpressen langsam bis zur letzten Umdrehung an.

**Juntas de compresion:** La resistencia se va incrementando paulatinamente hasta la vuelta final.

**Compressione di guarnizioni:** La resistenza di avvitamento gradualmente aumenta con il progredire dello schiacciamento al giro finale.

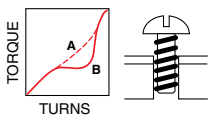

**Self-tapping screws:** Initial resistance high through tapping travel, easing off until sudden B or gradual A build-up for seating.

**Vis autotaraudeuses:** Forte résistance jusqu'à assise de la tête de vis, et montée en couple progressive (A) ou brutale (B) jusqu'au serrage final.

**Selbstschneidende Schrauben:** Hoher Anfangswiderstand während des Gewindeschneidweges, der nach leichtem Abfallen plötzlich oder allmählich bis zum Aufsitzen des Schraubenkopfes ansteigt.

**Tornillos autoroscantes:** Alta resistencia inicial de roscado hasta que B de pronto o A gradualmente llega a su asiento.

**Viti autofilettanti:** Alta resistenza iniziale durante la fase di filettatura; successiva diminuzione fino ad aumento istantaneo (B) o graduale (A) per la vite a battuta.

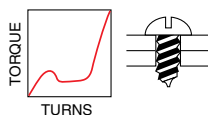

**Sheet metal screws:** Starting torque builds until penetration made, then resistance slacks off until head seats.

**Vis à tôle:** Résistance croissante jusqu'à pénétration, puis montée brutale du couple.

**Blechschraben:** Hohes Anfangsdrehmoment bis die Schraube das Blech durchbohrt hat, dann nachlassendes Moment bis der Schraubenkopf aufsitzt.

**Tornillos rosca chapa:** Resistencia inicial hasta la introducción, después afloja hasta que la cabeza asienta.

**Viti per lamiera:** La coppia di avviamento sale fino a che è fatta la penetrazione, quindi la resistenza diminuisce fino a che la vite va a battuta.

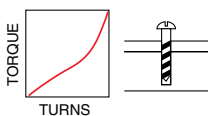

**Wood screws:** Low resistance at start builds gradually through entire rundown until head seats.

**Vis à bois:** Résistance croissante jusqu'au couple final atteint au contact de la tête de vis.

**Holzschrauben:** Geringer Anfangswiderstand, der bis zum Aufsitzen des Schraubenkopfes langsam ansteigt.

**Tornillos rosca madera:** Baja resistencia al principio, después afloja hasta que la cabeza asienta.

**Viti da legno:** La bassa resistenza all'avviamento gradualmente aumenta nel corso di tutto l'avvitamento fino a che la vite va a battuta.



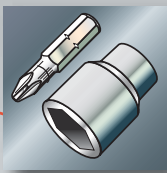

**1  
Series**

**Light Assembly Tools  
Outils d'assemblage légers  
Leichte Montagewerkzeuge  
Ligero montaje herramientas  
Leggero montaggio utensili**

**Standard  
Equipment**

**Clutch  
spring(s)**

**Soft touch,  
non-slip grip**

**Hanger  
(straight &  
angle models)**

Ressort(s)  
de limiteur

Revêtement  
anti-dérapant

Suspension  
(modèles droits  
et d'angle)

Kupplungs-  
federn

Weicher,  
rutschfester  
Griff

Aufhängung  
(gerade und  
Winkelmodelle)

Muelles de  
embrague

Empuñadura  
antideslizante

Suspensión  
(llaves con  
empuñadura  
recta y angul.)

Molle della  
frizione

Impugnatura  
antiscivolo

Dispositivo  
sospensione  
(modelli ad  
angolo e dritti)









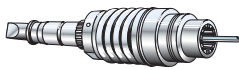



1RTMS1

Specifications at 90 psi – Caractéristiques à 620 kPa – Technische Daten bezogen auf 620 kPa  
Especificaciones a 620 kPa – Caratteristiche a 620 kPa

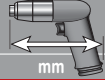
**Pistol Grip Screwdrivers • Visseuses à Poignée Révolver • Drehschrauber mit Pistolengriff •  
Atornilladores con Empuñadura de Pistola • Cacciaviti con Impugnatura a Pistola**

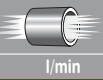





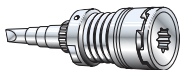



Adjustable shut-off clutch models — Modèles avec limiteur de couple réglable à coupure d'air — Modelle mit einstellbarer Abschaltkupplung — Modelos con parada automática — Modelli con frizione regolabile con blocco aria

Ref.	 Nm (1)	 Nm (1)	 Nm (1)	 rpm	 kg	 mm	 mm	 in	 l/min
<b>DC TRIGGER + PUSH START — GÂCHETTE + POUSSÉE — DRÜCKERSTART + SCHUBSTART — GATILLO + EMPUJE — GRILLETTO + SPINTA</b>									
1RTMS1	0.5 - 1.8	0.7-2.3	—	1650	0.68	217	17	1/4 	368
1RTNS1	0.3 - 1.8	0.5-2.6	1.1-3.4	1000	0.68	217	17	1/4 	368
1RTQS1	0.3 - 1.8	0.5-2.6	1. - 5.1	500	0.68	222	17	1/4 	368

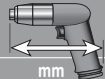

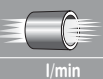
Adjustable cushion clutch models — Modèles avec limiteur de couple réglable à billes — Modelle mit einstellbarer Rutschkupplung — Modelos con embrague ajustable deslizante — Modelli con frizione regolabile a cuscino

Ref.	 Nm (1)	 Nm (1)	 Nm (1)	 rpm	 kg	 mm	 mm	 in	 l/min
<b>DC TRIGGER START — DÉM. PAR GÂCHETTE — DRÜCKERSTART — ARRANQUE POR GATILLO — AVVIAMENTO A GRILLETTO</b>									
1RAMC1	0.5 - 1.8	0.7-2.3	—	1650	0.68	217	17	1/4 	368
1RANC1	0.3 - 1.8	0.5-2.6	1.1-3.4	1000	0.68	217	17	1/4 	368







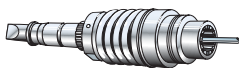



**Angle Wrenches • Clés d'Angle •  
Winkelschrauber • Llaves Angulares  
Chiavi ad Angolo**

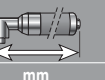

1RLN2S3

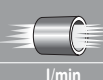

Adjustable shut-off clutch models — Modèles avec limiteur de couple réglable à coupure d'air — Modelle mit einstellbarer Abschaltkupplung — Modelos con parada automática — Modelli con frizione regolabile con blocco aria

Ref.	 Nm (1)	 Nm (1)	 Nm (1)	 rpm	 kg	 mm	 mm	 mm	 in	 l/min
<b>DC LEVER START — DÉM. PAR LEVIER — HEBELSTART — ARRANQUE POR PALANCA — AVVIAMENTO A LEVA</b>										
1RLM2S5	0.6 - 2.6	0.9-3.4	—	1100	0.79	318	13	33	1/4 	368
1RLN2S5	0.4 - 2.6	0.8-3.9	1.1-5.2	700	0.79	318	13	33	1/4 	368
1RLN2S3	0.4 - 2.6	0.8-3.9	1.1-5.2	700	0.79	318	13	31	1/4 	368

Light Assembly Tools  
Outils d'assemblage légers  
Leichte Montagewerkzeuge  
Ligero montaje herramientas  
Leggero montaggio utensili

1  
Series



Direct drive models — Modèles à entraînement direct — Modelle mit Direktantrieb — Modelos con accionamiento directo — Modelli a trasmissione diretta

Ref.									
<b>LEVER START — DÉM. PAR LEVIER — HEBELSTART — ARRANQUE POR PALANCA — AVVIAMENTO A LEVA</b>									
1RLN2D5	5.2	M4	700	0.60	211	13	33	1/4	368

Straight Screwdrivers · Visseuses Droites  
Druckluftdreherschrauber, gerade Ausführung  
Atornilladores con Empuñadura Recta  
Cacciaviti con Impugnatura Diritta

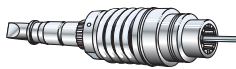

Adjustable shut-off clutch models — Modèles avec limiteur de couple réglable à coupure d'air — Modelle mit einstellbarer Abschaltkupplung — Modelos con parada automática — Modelli con frizione regolabile con blocco aria

Ref.									
<b>LEVER START — DÉM. PAR LEVIER — HEBELSTART — ARRANQUE POR PALANCA — AVVIAMENTO A LEVA</b>									
1RLNS1	<b>0.3 - 1.8</b>	0.5-2.6	1.1-3.4	1000	0.5	222	14	1/4	368
1RLQS1	<b>0.3 - 1.8</b>	0.5-2.6	<b>1. - 5.1</b>	500	0.5	222	17	1/4	368
<b>PUSH START — DEM. PAR POUSSÉE — SCHUBSTART — ARRANQUE POR EMPUJE — AVVIAMENTO A SPINTA</b>									
1RPLS1	<b>0.5 - 1.5</b>	—	—	2800	0.5	213	14	1/4	368
1RPMS1	<b>0.5 - 1.8</b>	0.7-2.3	—	1650	0.5	222	14	1/4	368
1RPNS1	<b>0.3 - 1.8</b>	0.5-2.6	1.1-3.4	1000	0.5	222	14	1/4	368
1RPQS1	<b>0.3 - 1.8</b>	0.5-2.6	<b>1. - 5.1</b>	500	0.5	222	17	1/4	368

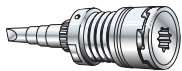

Adjustable cushion clutch models — Modèles avec limiteur de couple réglable à billes — Modelle mit einstellbarer Rutschkupplung — Modelos con embrague ajustable deslizante — Modelli con frizione regolabile a cuscino

Ref.									
<b>LEVER START — DÉM. PAR LEVIER — HEBELSTART — ARRANQUE POR PALANCA — AVVIAMENTO A LEVA</b>									
1RLMC1	<b>0.5 - 1.8</b>	0.7-2.3	—	1650	0.5	222	14	1/4	368
1RLNC1	<b>0.3 - 1.8</b>	0.5-2.6	1.1-3.4	1000	0.5	222	14	1/4	368
<b>PUSH START — DEM. PAR POUSSÉE — SCHUBSTART — ARRANQUE POR EMPUJE — AVVIAMENTO A SPINTA</b>									
1RPMC1	<b>0.5 - 1.8</b>	0.7-2.3	—	1650	0.5	222	14	1/4	368
1RPNC1	<b>0.3 - 1.8</b>	0.5-2.6	1.1-3.4	1000	0.5	222	14	1/4	368

(1) Clutch springs delivered with the tool: the torque range indicated in bold letter corresponds to the spring installed on the tool.  
(1) Ressorts de limiteur fournis avec la machine: la gamme de couple indiquée en gras correspond au ressort monté sur la machine.  
(1) Kupplungsfedern werden mitgeliefert, fett gedruckte Drehmomentangaben gelten für werkseitig eingebaute Feder  
(1) Muelles de embrague entregados con la herramienta: la gama de par en negrita corresponde con el muelle instalado en la herramienta.  
(1) Molle della frizione fornite con la macchina: la molla indicata in grossetto corrisponde a quella montata sulla macchina.

Series / Baureihe			
1	73 dBa	1/8" NPT	6 mm

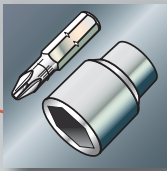

**Q2  
Series**

**Light Assembly Tools  
Outils d'assemblage légers  
Leichte Montagewerkzeuge  
Ligero montaje herramientas  
Leggero montaggio utensili**

**Standard  
Equipment**

Clutch spring(s)  
(models  
with clutch)  
Top or bottom  
air inlet

Ressort(s)  
de limiteur  
(modèles à  
limiteur)

Entrée d'air  
par le dessus ou  
par la poignée

Kupplungs-  
federn  
(Modelle mit  
Einstellbare  
Kupplung)

Lufteinlass  
oben oder  
durch den  
Handgriff

Muelles de  
embrague  
(modelos con  
embrague)

Entrada de aire  
por arriba o  
por el puñado

Molle della  
frizione (modelli  
con frizione  
regolabile)

Ingresso aria  
dall'alto o dal  
basso



See our Qualifier for pneumatic tools page 52  
Voir notre Boîtier d'Assistance Qualité  
pour outils pneumatiques page 52  
Qualifikator für Druckluftwerkzeuge, Seite 52  
Ver nuestro Cualificador de Procesos  
para Herramientas Neumáticas página 52  
Vedere il nostro Qualificatore di Processo  
per Utensili Pneumatici pag. 52

Specifications at 90 psi – Caractéristiques à 620 kPa – Technische Daten bezogen auf 620 kPa  
Especificaciones a 620 kPa – Caratteristiche a 620 kPa

**Pistol Grip Screwdrivers  
Visseuses à Poignée Révolver  
Drehschrauber mit Pistolengriff  
Atornilladores con Empuñadura de Pistola  
Cacciaviti con Impugnatura a Pistola**



QP1T20S1TD

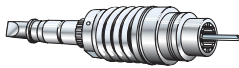

Adjustable shut-off clutch models — Modèles avec limiteur de couple réglable à coupure d'air — Modelle mit einstellbarer Abschaltkupplung — Modelos con parada automática — Modelli con frizione regolabile con blocco aria

Ref.	Nm <sup>(1)</sup>	Nm <sup>(1)</sup>	Nm <sup>(1)</sup>	1 min. rpm	kg	mm	mm	in	l/min
<b>DC TRIGGER START — DÉM. PAR GÂCHETTE — DRÜCKERSTART — ARRANQUE POR GATILLO — AVVIAMENTO A GRILLETTO</b>									
QP1S20S1TD	0.3 - 1.1	<b>0.9 - 2.5</b>	—	2000	0.84	223	15	1/4	450
QP1S15S1TD	0.3 - 1.1	<b>0.9 - 3.1</b>	—	1500	0.84	223	15	1/4	450
QP1S10S1TD	0.3 - 1.1	0.9 - 2.5	<b>1.5 - 4.5</b>	1000	0.84	223	15	1/4	450
QP1S05S1TD	0.3 - 1.1	0.9 - 3.2	<b>1.5 - 5.4</b>	500	0.84	223	15	1/4	450
QP1S02S1TD	0.3 - 1.1	0.9 - 3.2	<b>1.5 - 5.4</b>	250	0.84	223	15	1/4	450
<b>DC TRIGGER + PUSH START — GÂCHETTE + POUSSÉE — DRÜCKERSTART + SCHUBSTART — GATILLO + EMPUJE — GRILLETTO + SPINTA</b>									
QP1T20S1TD	0.3 - 1.1	<b>0.9 - 2.5</b>	—	2000	0.84	223	15	1/4	450
QP1T15S1TD	0.3 - 1.1	<b>0.9 - 3.1</b>	—	1500	0.84	223	15	1/4	450
QP1T10S1TD	0.3 - 1.1	0.9 - 2.5	<b>1.5 - 4.5</b>	1000	0.84	223	15	1/4	450
QP1T05S1TD	0.3 - 1.1	0.9 - 3.2	<b>1.5 - 5.4</b>	500	0.84	223	15	1/4	450
QP1T02S1TD	0.3 - 1.1	0.9 - 3.2	<b>1.5 - 5.4</b>	250	0.84	223	15	1/4	450

(1) Clutch springs delivered with the tool: the torque range indicated in bold letter corresponds to the spring installed on the tool.  
(1) Ressorts de limiteur fournis avec la machine: la gamme de couple indiquée en gras correspond au ressort monté sur la machine.  
(1) Kupplungsfedern werden mitgeliefert, fett gedruckte Drehmomentangaben gelten für werksseitig eingebaute Feder  
(1) Muelles de embrague entregados con la herramienta: la gama de par en negrita corresponde con el muelle instalado en la herramienta.  
(1) Molle della frizione fornite con la macchina: la molla indicata in grassetto corrisponde a quella montata sulla macchina.

Series / Baureihe			
Q2	75 dBa	1/4" NPT	6 mm

Light Assembly Tools  
Outils d'assemblage légers  
Leichte Montagewerkzeuge  
Ligero montaje herramientas  
Leggero montaggio utensili

Q2  
Series

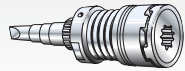

Adjustable cushion clutch models  
Modèles avec limiteur de couple réglable à billes  
Modelle mit einstellbarer Rutschkupplung  
Modelos con embrague ajustable deslizante  
Modelli con frizione regolabile a cuscono



QP1T17C1TD

Ref.	Nm <sup>(1)</sup>	Nm <sup>(1)</sup>	Nm <sup>(1)</sup>	rpm	kg	mm	mm	in	l/min
<b>DC TRIGGER START — DÉM. PAR GÂCHETTE — DRÜCKERSTART — ARRANQUE POR GATILLO — AVVIAMENTO A GRILLETTO</b>									
QP1S15C1TD	0.3 - 1.1	<b>0.9 - 3.1</b>	—	1500	0.84	223	15	1/4	450
QP1S10C1TD	0.3 - 1.1	0.9 - 2.5	<b>1.5 - 4.5</b>	1000	0.84	223	15	1/4	450
QP1S05C1TD	0.3 - 1.1	0.9 - 3.2	<b>1.5 - 5.4</b>	500	0.84	223	15	1/4	450
<b>TRIGGER + PUSH START — GÂCHETTE + POUSSÉE — DRÜCKERSTART + SCHUBSTART — GATILLO + EMPUJE — GRILLETTO + SPINTA</b>									
QP1T15C1TD	0.3 - 1.1	<b>0.9 - 3.1</b>	—	1500	0.84	223	15	1/4	450
QP1T10C1TD	0.3 - 1.1	0.9 - 2.5	<b>1.5 - 4.5</b>	1000	0.84	223	15	1/4	450



Direct drive models  
Modèles à entraînement direct  
Modelle mit Direktantrieb  
Modelos con accionamiento directo  
Modelli a trasmissione diretta



QP1S10D1TD

Ref.	Nm	Thread	rpm	kg	mm	mm	in	l/min
<b>DC TRIGGER START — DÉM. PAR GÂCHETTE — DRÜCKERSTART — ARRANQUE POR GATILLO — AVVIAMENTO A GRILLETTO</b>								
QP1S20D1TD	2.9	M3	2000	0.68	162	15	1/4	450
QP1S15D1TD	3.4	M4	1500	0.68	162	15	1/4	450
QP1S10D1TD	5.2	M5	1000	0.68	162	15	1/4	450
QP1S05D1TD	9.8	M6	500	0.68	162	15	1/4	450

(1) Clutch springs delivered with the tool: the torque range indicated in bold letter corresponds to the spring installed on the tool.  
(1) Ressorts de limiteur fournis avec la machine: la gamme de couple indiquée en gras correspond au ressort monté sur la machine.  
(1) Kupplungsfedern werden mitgeliefert, fett gedruckte Drehmomentangaben gelten für werkseitig eingebaute Feder  
(1) Muelles de embrague entregados con la herramienta: la gama de par en negrita corresponde con el muelle instalado en la herramienta.  
(1) Molle della frizione fornite con la macchina: la molla indicata in grossetto corrisponde a quella montata sulla macchina.

Series / Baureihe			
Q2	75 dBa	1/4" NPT	6 mm

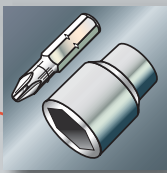

**Q2  
Series**

**Light Assembly Tools  
Outils d'assemblage légers  
Leichte Montagewerkzeuge  
Ligero montaje herramientas  
Leggero montaggio utensili**

**Standard  
Equipment**

**Clutch spring(s)  
(models  
with clutch)**

**Speed  
adjustment  
facility through  
the exhaust**

**Vertical hanger**

Ressort(s) de  
limiteur (mod.  
avec limiteur)

Contrôle de la  
vitesse par  
l'échappement

Suspension  
verticale

Kupplungsfedern  
(Modelle mit  
Einstellbarer  
Kupplung)

Geschwindig-  
keitsregelung

Vertikal-  
Aufhänger

Muelles de  
embrague (mod.  
con embrague  
ajustable)

Mando de  
variación de la  
velocidad

Susp. vertical

Molle della  
frizione (modelli  
con frizione  
regolabile)

Regolazione  
variabile della  
velocità

Sosp. verticale



See our Qualifier for pneumatic tools page 52

Voir notre Boîtier d'Assistance Qualité

pour outils pneumatiques page 52

Qualifikator für Druckluftwerkzeuge, Seite 52

Ver nuestro Cualificador de Procesos

para Herramientas Neumáticas página 52

Vedere il nostro Qualificatore di Processo  
per Utensili Pneumatici pag. 52

Specifications at 90 psi – Caractéristiques à 620 kPa – Technische Daten bezogen auf 620 kPa  
Especificaciones a 620 kPa – Caratteristiche a 620 kPa

**Angle Wrenches  
Clés d'Angle  
Winkelschrauber  
Llaves Angulares  
Chiavi ad Angolo**



QA1L05S4LD

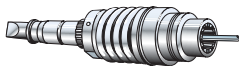

Adjustable shut-off clutch models — Modèles avec limiteur de couple réglable à coupure d'air — Modelle mit einstellbarer Abschaltkupplung — Modelos con parada automática — Modelli con frizione regolabile con blocco aria

Ref.										
	Nm (1)	Nm (1)	Nm (1)	rpm	kg	mm	mm	mm	in	l/min
<b>DC LEVER START — DÉM. PAR LEVIER — HEBELSTART — ARRANQUE POR PALANCA — AVVIAMENTO A LEVA</b>										
QA1L12S1LD	0.4 - 1.3	<b>1.05 - 3.7</b>	—	1270	0.95	302	13	34	1/4	450
QA1L08S1LD	0.4 - 1.3	1.05 - 3.8	<b>1.8 - 5.3</b>	850	0.95	302	13	34	1/4	450
QA1L05S1LD	0.4 - 1.3	1.05 - 3.8	<b>1.8 - 6.4</b>	500	0.95	302	13	34	1/4	450
QA1L02S1LD	0.4 - 1.3	1.05 - 3.8	<b>1.8 - 6.4</b>	250	0.95	302	13	34	1/4	450
QA1L05S1XLD	1.4 - 4.3	<b>3.5 - 10.0</b>	—	500	1.03	329	13	34	1/4	450
QA1L02S1XLD	1.4 - 4.3	<b>3.5 - 11.5</b>	—	250	1.03	329	13	34	1/4	450

Ref.										
	Nm (1)	Nm (1)	Nm (1)	rpm	kg	mm	mm	mm	in	l/min
<b>DC LEVER START — DÉM. PAR LEVIER — HEBELSTART — ARRANQUE POR PALANCA — AVVIAMENTO A LEVA</b>										
QA1L12S4SD	0.4 - 1.3	<b>1.05 - 3.7</b>	—	1270	0.85	299	9.5	27	1/4	450
QA1L12S4LD	0.4 - 1.3	<b>1.05 - 3.7</b>	—	1270	0.95	302	13	34	1/4	450
QA1L05S4SD	0.4 - 1.3	<b>1.05 - 4.1</b>	—	500	0.85	299	9.5	27	1/4	450
QA1L08S4LD	0.4 - 1.3	1.05 - 3.8	<b>1.8 - 5.3</b>	850	0.95	302	13	34	1/4	450
QA1L08S6LD	0.4 - 1.3	1.05 - 3.8	<b>1.8 - 5.3</b>	850	0.95	302	13	34	3/8	450
QA1L05S4LD	0.4 - 1.3	1.05 - 3.8	<b>1.8 - 6.4</b>	500	0.95	302	13	34	1/4	450
QA1L05S6LD	0.4 - 1.3	1.05 - 3.8	<b>1.8 - 6.4</b>	500	0.95	302	13	34	3/8	450
QA1L02S6LD	0.4 - 1.3	1.05 - 3.8	<b>1.8 - 6.4</b>	250	0.95	302	13	34	3/8	450
QA1L05S6XLD	1.4 - 4.3	<b>3.5 - 10.0</b>	—	500	1.03	329	13	34	3/8	450
QA1L02S6XLD	1.4 - 4.3	<b>3.5 - 11.5</b>	—	250	1.03	329	13	34	3/8	450

Light Assembly Tools  
Outils d'assemblage légers  
Leichte Montagewerkzeuge  
Ligero montaje herramientas  
Leggero montaggio utensili

Q2  
Series



QA1L08C4LD



1

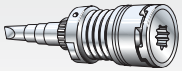

Adjustable cushion clutch models — Modèles avec limiteur de couple réglable à billes — Modelle mit einstellbarer Rutschkupplung — Modelos con embrague ajustable deslizante — Modelli con frizione regolabile a cuscono

Ref.										
	Nm (1)	Nm (1)	Nm (1)	rpm	kg	mm	mm	mm	in	l/min
<b>LEVER START — DÉM. PAR LEVIER — HEBELSTART — ARRANQUE POR PALANCA — AVVIAMENTO A LEVA</b>										
QA1L12C1LD	0.4 - 1.3	<b>1.05 - 3.7</b>	—	1270	0.95	302	13	34	1/4	450
QA1L08C1LD	0.4 - 1.3	1.05 - 3.8	<b>1.8 - 5.3</b>	850	0.95	302	13	34	1/4	450
QA1L05C1LD	0.4 - 1.3	1.05 - 3.8	<b>1.8 - 6.4</b>	500	0.95	302	13	34	1/4	450

Ref.										
	Nm (1)	Nm (1)	Nm (1)	rpm	kg	mm	mm	mm	in	l/min
<b>LEVER START — DÉM. PAR LEVIER — HEBELSTART — ARRANQUE POR PALANCA — AVVIAMENTO A LEVA</b>										
QA1L08C4LD	0.4 - 1.3	1.05 - 3.8	<b>1.8 - 5.3</b>	850	0.95	302	13	34	1/4	450
QA1L05C4LD	0.4 - 1.3	1.05 - 3.8	<b>1.8 - 6.4</b>	500	0.95	302	13	34	1/4	450



Direct drive models — Modèles à entraînement direct — Modelle mit Direktantrieb — Modelos con accionamiento directo — Modelli a trasmissione diretta

Ref.									
	Nm		rpm	kg	mm	mm	mm	in	l/min
<b>LEVER START — DÉM. PAR LEVIER — HEBELSTART — ARRANQUE POR PALANCA — AVVIAMENTO A LEVA</b>									
QA1L12D1LD	4.0	M4	1270	0.70	227	13	34	1/4	450
QA1L08D1LD	6.8	M5	850	0.70	227	13	34	1/4	450

Ref.									
	Nm		rpm	kg	mm	mm	mm	in	l/min
<b>LEVER START — DÉM. PAR LEVIER — HEBELSTART — ARRANQUE POR PALANCA — AVVIAMENTO A LEVA</b>									
QA1L12D4LD	4.0	M4	1270	0.70	227	13	34	1/4	450
QA1L08D4LD	6.8	M5	850	0.70	227	13	34	1/4	450
QA1L05D4LD	11.6	M6	500	0.70	227	13	34	1/4	450

(1) Clutch springs delivered with the tool: the torque range indicated in bold letter corresponds to the spring installed on the tool.  
 (1) Ressorts de limiteur fournis avec la machine: la gamme de couple indiquée en gras correspond au ressort monté sur la machine.  
 (1) Kupplungsfedern werden mitgeliefert, fett gedruckte Drehmomentangaben gelten für werkseitig eingebaute Feder  
 (1) Muelles de embrague entregados con la herramienta: la gama de par en negrita corresponde con el muelle instalado en la herramienta.  
 (1) Molle della frizione fornite con la macchina: la molla indicata in grossetto corrisponde a quella montata sulla macchina.

Series / Baureihe			
Q2	75 dBa	1/4" NPT	6 mm



**Q2  
Series**

**Light Assembly Tools  
Outils d'assemblage légers  
Leichte Montagewerkzeuge  
Ligero montaje herramientas  
Leggero montaggio utensili**

**Standard  
Equipment**

**Clutch spring(s)  
(models  
with clutch)**

**Speed  
adjustment  
facility through  
the exhaust**

**Vertical hanger**

Ressort(s) de  
limiteur (mod.  
avec limiteur)

Contrôle de la  
vitesse par  
l'échappement

Suspension  
verticale

Kupplungsfedern  
(Modelle mit  
Einstellbarer  
Kupplung)

Geschwindig-  
keitsregelung

Vertikal-  
Aufhänger

Muelles de  
embrague (mod.  
con embrague  
ajustable)

Mando de  
variación de la  
velocidad

Susp. vertical

Molle della  
frizione (modelli  
con frizione  
regolabile)

Regolazione  
variabile della  
velocità

Sosp. verticale



*See our Qualifier for pneumatic tools page 52  
Voir notre Boîtier d'Assistance Qualité  
pour outils pneumatiques page 52  
Qualifikator für Druckluftwerkzeuge, Seite 52  
Ver nuestro Cualificador de Procesos  
para Herramientas Neumáticas página 52  
Vedere il nostro Qualificatore di Processo  
per Utensili Pneumatici pag. 52*

Specifications at 90 psi – Caractéristiques à 620 kPa – Technische Daten bezogen auf 620 kPa  
Especificaciones a 620 kPa – Caratteristiche a 620 kPa







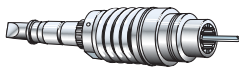

















**Straight Screwdrivers  
Visseuses Droites  
Druckluftdreherschrauber, gerade Ausführung  
Atornilladores con Empuñadura Recta  
Cacciaviti con Impugnatura Diritta**



QS1P20S1D



*Adjustable shut-off clutch models — Modèles avec limiteur de couple réglable à coupure d'air — Modelle mit einstellbarer Abschaltkupplung — Modelos con parada automática — Modelli con frizione regolabile con blocco aria*

Ref.	 Nm <sup>(1)</sup>	 Nm <sup>(1)</sup>	 Nm <sup>(1)</sup>	 1 min. rpm	 kg	 mm	 mm	 in	 l/min
<b>DC LEVER START — DÉM. PAR LEVIER — HEBELSTART — ARRANQUE POR PALANCA — AVVIAMENTO A LEVA</b>									
QS1L20S1D	0.3 - 1.1	<b>0.9 - 2.5</b>	—	2000	0.70	241	22	1/4 	450
QS1L15S1D	0.3 - 1.1	<b>0.9 - 3.1</b>	—	1500	0.70	241	22	1/4 	450
QS1L10S1D	0.3 - 1.1	0.9 - 2.5	<b>1.5 - 4.5</b>	1000	0.70	241	22	1/4 	450
QS1L05S1D	0.3 - 1.1	0.9 - 3.2	<b>1.5 - 5.4</b>	500	0.70	241	22	1/4 	450
QS1L02S1D	0.3 - 1.1	0.9 - 3.2	<b>1.5 - 5.4</b>	250	0.70	241	22	1/4 	450
<b>DC LEVER + PUSH START — LEVIER + POUSSÉE — HEBELSTART + SCHUBSTART — PALANCA + EMPUJE — LEVA + SPINTA</b>									
QS1T20S1D	0.3 - 1.1	<b>0.9 - 2.5</b>	—	2000	0.70	241	22	1/4 	450
QS1T15S1D	0.3 - 1.1	<b>0.9 - 3.1</b>	—	1500	0.70	241	22	1/4 	450
QS1T10S1D	0.3 - 1.1	0.9 - 2.5	<b>1.5 - 4.5</b>	1000	0.70	241	22	1/4 	450
QS1T05S1D	0.3 - 1.1	0.9 - 3.2	<b>1.5 - 5.4</b>	500	0.70	241	22	1/4 	450
QS1T02S1D	0.3 - 1.1	0.9 - 3.2	<b>1.5 - 5.4</b>	250	0.70	241	22	1/4 	450
<b>DC PUSH START — DEM. PAR POUSSÉE — SCHUBSTART — ARRANQUE POR EMPUJE — AVVIAMENTO A SPINTA</b>									
QS1P20S1D	0.3 - 1.1	<b>0.9 - 2.5</b>	—	2000	0.62	223	22	1/4 	450
QS1P15S1D	0.3 - 1.1	<b>0.9 - 3.1</b>	—	1500	0.62	223	22	1/4 	450
QS1P10S1D	0.3 - 1.1	0.9 - 2.5	<b>1.5 - 4.5</b>	1000	0.62	223	22	1/4 	450
QS1P05S1D	0.3 - 1.1	0.9 - 3.2	<b>1.5 - 5.4</b>	500	0.62	223	22	1/4 	450
QS1P02S1D	0.3 - 1.1	0.9 - 3.2	<b>1.5 - 5.4</b>	250	0.62	223	22	1/4 	450



Light Assembly Tools  
Outils d'assemblage légers  
Leichte Montagewerkzeuge  
Ligero montaje herramientas  
Leggero montaggio utensili

Q2  
Series



QS1P10C1D

1

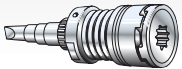

Adjustable cushion clutch models — Modèles avec limiteur de couple réglable à billes — Modelle mit einstellbarer Rutschkupplung — Modelos con embrague ajustable deslizante — Modelli con frizione regolabile a cuscono

Ref.	Nm <sup>(1)</sup>	Nm <sup>(1)</sup>	Nm <sup>(1)</sup>	rpm	kg	mm	mm	in	l/min
<b>DC LEVER START — DÉM. PAR LEVIER — HEBELSTART — ARRANQUE POR PALANCA — AVVIAMENTO A LEVA</b>									
QS1L20C1D	0.3 - 1.1	<b>0.9 - 3.1</b>	—	2000	0.70	241	22	1/4	450
QS1L10C1D	0.3 - 1.1	0.9 - 2.5	<b>1.5 - 4.5</b>	1000	0.70	241	22	1/4	450
QS1L05C1D	0.3 - 1.1	0.9 - 3.2	<b>1.5 - 5.4</b>	500	0.70	241	22	1/4	450
<b>DC LEVER + PUSH START — LEVIER + POUSSÉE — HEBELSTART + SCHUBSTART — PALANCA + EMPUJE — LEVA + SPINTA</b>									
QS1T20C1D	0.3 - 1.1	<b>0.9 - 3.1</b>	—	2000	0.70	241	22	1/4	450
QS1T05C1D	0.3 - 1.1	0.9 - 3.2	<b>1.5 - 5.4</b>	500	0.70	241	22	1/4	450
<b>DC PUSH START — DEM. PAR POUSSÉE — SCHUBSTART — ARRANQUE POR EMPUJE — AVVIAMENTO A SPINTA</b>									
QS1P20C1D	0.3 - 1.1	<b>0.9 - 3.1</b>	—	2000	0.62	223	22	1/4	450
QS1P10C1D	0.3 - 1.1	0.9 - 2.5	<b>1.5 - 4.5</b>	1000	0.62	223	22	1/4	450
QS1P05C1D	0.3 - 1.1	0.9 - 3.2	<b>1.5 - 5.4</b>	500	0.62	223	22	1/4	450



QS1L10D1D



Direct drive models — Modèles à entraînement direct — Modelle mit Direktantrieb — Modelos con accionamiento directo — Modelli a trasmissione diretta

Ref.	Nm <sup>(1)</sup>		rpm	kg	mm	mm	in	l/min
<b>DC LEVER START — DÉM. PAR LEVIER — HEBELSTART — ARRANQUE POR PALANCA — AVVIAMENTO A LEVA</b>								
QS1L20D1D	2.9	M3	2000	0.60	241	22	1/4	450
QS1L10D1D	5.8	M5	1000	0.60	241	22	1/4	450

(1) Clutch springs delivered with the tool: the torque range indicated in bold letter corresponds to the spring installed on the tool.  
 (1) Ressorts de limiteur fournis avec la machine: la gamme de couple indiquée en gras correspond au ressort monté sur la machine.  
 (1) Kupplungsfedern werden mitgeliefert, fett gedruckte Drehmomentangaben gelten für werkseitig eingebaute Feder  
 (1) Muelles de embrague entregados con la herramienta: la gama de par en negrita corresponde con el muelle instalado en la herramienta.  
 (1) Molle della frizione fornite con la macchina: la molla indicata in grossetto corrisponde a quella montata sulla macchina.

Series / Baureihe			
Q2	75 dBa	1/4" NPT	6 mm

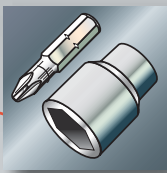

**41  
Series**

**Medium & Heavy Assembly Tools**  
**Outils d'assemblage moyens et lourds**  
**Mittlere und schwere Montagewerkzeuge**  
**Intermedio y constantemente montaje herramientas**  
**Medie e forte montaggio utensili**

**Standard  
Equipment**

Clutch spring(s)  
(models with clutch)

Skinsulate™  
soft touch,  
non-slip grip  
(on pistol models)

Hanger  
(on angle  
wrenches)

Ressort(s)  
de limiteur  
(modèles à  
limiteur)

Revêtement  
anti-dérapant  
Skinsulate™  
(modèles  
à poignée  
révolver)

Suspension  
(clés d'angle)

Kupplungsfedern  
(Modelle mit  
Einstellbare  
Kupplung)

Skinsulate™  
Weicher,  
rutschfester Griff  
(Modellen mit  
Pistolengriff)

Aufhänger  
(Winkelschrauber)

Muelles de  
embrague (mod.  
con embrague)

Empuñadura  
suave,  
antideslizante  
Skinsulate™  
(modelos con  
empuñadura  
de pistola)

Suspensión  
(llaves  
angulares)

Molle della  
frizione  
(mod. con frizione  
regolabile)

Impugnatura  
morbida,  
antiscivolo  
Skinsulate™  
(modelli con  
imp. a pistola)

Dispositivo  
sospensione  
(chiavi ad angolo)



See our Qualifier for pneumatic tools page 52

Voir notre Boîtier d'Assistance Qualité pour outils pneumatiques page 52

Qualifikator für Druckluftwerkzeuge, Seite 52

Ver nuestro Cualificador de Procesos para Herramientas Neumáticas página 52

Vedere il nostro Qualificatore di Processo per Utensili Pneumatici pag. 52

Specifications at 90 psi – Caractéristiques à 620 kPa – Technische Daten bezogen auf 620 kPa  
 Especificaciones a 620 kPa – Caratteristiche a 620 kPa

**Pistol Grip Screwdrivers**  
**Visseuses à Poignée Révolver**  
**Drehschrauber mit Pistolengriff**  
**Atornilladores con Empuñadura de Pistola**  
**Cacciaviti con Impugnatura a Pistola**

**Skinsulate™**  
Comfort Coating



41PA10TSQ4-EU

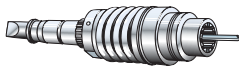

Adjustable shut-off clutch models — Modèles avec limiteur de couple réglable à coupure d'air — Modelle mit einstellbarer Abschaltkupplung — Modelos con parada automática — Modelli con frizione regolabile con blocco aria

Ref.	Nm (1)	Nm (1)	Nm (1)	rpm	kg	mm	mm	in	l/min
<b>DC TRIGGER START — DÉM. PAR GÂCHETTE — DRÜCKERSTART — ARRANQUE POR GATILLO — AVVIAMENTO A GRILLETTO</b>									
41PA10TSQ4-EU	1.7 - 4.5	2.8 - 6.8	<b>4.0 - 9.0</b>	1000	1.40	249	22	1/4	790
41PA8TSQ4-EU	1.7 - 4.5	2.8 - 6.8	<b>4.0 - 11.3</b>	800	1.40	249	22	1/4	790
<b>DC TRIGGER + PUSH START — GÂCHETTE + POUSSÉE — DRÜCKERSTART + SCHUBSTART — GATILLO + EMPUJE — GRILLETTO + SPINTA</b>									
41PA16TPQ4-EU	1.7 - 4.5	<b>2.8 - 6.8</b>	—	1600	1.40	249	22	1/4	790
41PA10TPQ4-EU	1.7 - 4.5	2.8 - 6.8	<b>4.0 - 9.0</b>	1000	1.40	249	22	1/4	790
41PA8TPQ4-EU	1.7 - 4.5	2.8 - 6.8	<b>4.0 - 11.3</b>	800	1.40	249	22	1/4	790

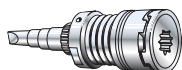

Adjustable cushion clutch models  
 Modèles avec limiteur de couple réglable à billes  
 Modelle mit einstellbarer Rutschkupplung  
 Modelos con embrague ajustable deslizante  
 Modelli con frizione regolabile a cuscino



41PC17TSQ4-EU

**Skinsulate™**  
Comfort Coating

Ref.	Nm (1)	Nm (1)	Nm (1)	rpm	kg	mm	mm	in	l/min
<b>DC TRIGGER START — DÉM. PAR GÂCHETTE — DRÜCKERSTART — ARRANQUE POR GATILLO — AVVIAMENTO A GRILLETTO</b>									
41PC17TSQ4-EU	1.7 - 4.5	<b>1.7 - 6.0</b>	—	1700	1.40	239	20	1/4	565
41PC10TSQ4-EU	1.7 - 4.5	<b>1.7 - 9.0</b>	—	1000	1.40	239	20	1/4	565
41PC8TSQ4-EU	1.7 - 4.5	1.7 - 9.0	<b>5.1 - 11.3</b>	800	1.40	239	20	1/4	565

Medium & Heavy Assembly Tools  
Outils d'assemblage moyens et lourds  
Mittlere und schwere Montagewerkzeuge  
Intermedio y constantemente montaje herramientas  
Medie e forte montaggio utensili

41  
Series



41PP25TSQ4-EU



Skinsulate™  
Comfort Coating

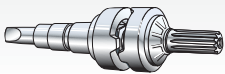

Positive jaw clutch models — Modèles avec limiteur de couple à clabots — Modelle mit nicht einstellbarer Klauenkupplung — Modelos con embrague positivo — Modelli con frizione a ganasce oblique

Ref.	Nm	M3 - M5	rpm	kg	mm	mm	in	l/min
<b>TRIGGER START — DÉM. PAR GÂCHETTE — DRÜCKERSTART — ARRANQUE POR GATILLO — AVVIAMENTO A GRILLETTO</b>								
41PP25TSQ4-EU	5.1	M3 - M5	2500	1.0	183	20	1/4	565
41PP17TSQ4-EU	7.3	M4 - M6	1700	1.1	193	20	1/4	565
41PP8TSQ4-EU	13.6	M5 - M6	800	1.1	193	20	1/4	565



Direct drive models — Modèles à entraînement direct — Modelle mit Direktantrieb — Modelos con accionamiento directo — Modelli a trasmissione diretta

Ref.	Nm	M5	rpm	kg	mm	mm	in	l/min
<b>TRIGGER START — DÉM. PAR GÂCHETTE — DRÜCKERSTART — ARRANQUE POR GATILLO — AVVIAMENTO A GRILLETTO</b>								
41PD17TSQ4-EU	7.3	M5	1700	1.0	188	20	1/4	565
41PD8TSQ4-EU	13.6	M6	800	1.0	188	20	1/4	565

Angle Wrenches  
Clés d'Angle  
Winkelschrauber  
Llaves Angulares  
Chiavi ad Angolo



41AA9LTS6-EU

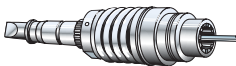

Adjustable shut-off clutch models — Modèles avec limiteur de couple réglable à coupure d'air — Modelle mit einstellbarer Abschaltkupplung — Modelos con parada automática — Modelli con frizione regolabile con blocco aria

Ref.	Nm (1)	Nm (1)	Nm (1)	rpm	kg	mm	mm	mm	in	l/min
<b>LEVER START — DÉM. PAR LEVIER — HEBELSTART — ARRANQUE POR PALANCA — AVVIAMENTO A LEVA</b>										
41AA9LTS6-EU	2.8 - 6.6	<b>2.8 - 10.2</b>	—	950	1.80	361	15	38	3/8	870
41AA6LTS6-EU	2.5 - 5.8	2.5 - 9.1	<b>4 - 14.7</b>	600	1.80	361	16	48	3/8	870

(1) Clutch springs delivered with the tool: the torque range indicated in bold letter corresponds to the spring installed on the tool.

(1) Ressorts de limiteur fournis avec la machine: la gamme de couple indiquée en gras correspond au ressort monté sur la machine.

(1) Kupplungsfedern werden mitgeliefert, fett gedruckte Drehmomentangaben gelten für werkseitig eingebaute Feder

(1) Muelles de embrague entregados con la herramienta: la gama de par en negrita corresponde con el muelle instalado en la herramienta.

(1) Molle della frizione fornite con la macchina: la molla indicata in grossetto corrisponde a quella montata sulla macchina.

Series / Baureihe	78 dBa	1/4" NPT	8 mm
41	78 dBa	1/4" NPT	8 mm

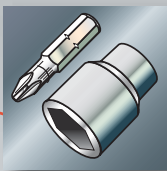

**41 Series**

**Medium & Heavy Assembly Tools**  
**Outils d'assemblage moyens et lourds**  
**Mittlere und schwere Montagewerkzeuge**  
**Intermedio y constantemente montaje herramientas**  
**Medie e forte montaggio utensili**

**Standard Equipment**

Clutch spring(s)

Skinsulate™ soft touch, non-slip grip

Vertical Hanger

Ressort(s) de limiteur

Revêtement anti-dérapant Skinsulate™

Suspension verticale

Kupplungs-federn

Skinsulate™ Weicher, rutschfester Griff

Vertikal-Aufhänger

Muelles de embrague

Empuñadura suave, antideslizante Skinsulate™

Suspensión vertical

Molle della frizione

Impugnatura morbida, antiscivolo Skinsulate™

Disp. sospensione verticale

Specifications at 90 psi – Caractéristiques à 620 kPa  
 Technische Daten bezogen auf 620 kPa  
 Especificaciones a 620 kPa – Caratteristiche a 620 kPa

**Straight Screwdrivers**  
**Visseuses Droites**  
**Druckluftdreherschrauber, gerade Ausführung**  
**Atornilladores con Empuñadura Recta**  
**Cacciaviti con Impugnatura Diritta**



**Skinsulate™**  
 Comfort Coating

41SA10PSQ4-EU

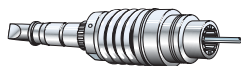

Adjustable shut-off clutch models — Modèles avec limiteur de couple réglable à coupure d'air — Modelle mit einstellbarer Abschaltkupplung — Modelos con parada automática — Modelli con frizione regolabile con blocco aria

Ref.	Nm (1)	Nm (1)	Nm (1)	rpm	kg	mm	mm	in	l/min
<b>DC LEVER + PUSH START — LEVIER + POUSÉE — HEBELSTART + SCHUBSTART — PALANCA + EMPUJE — LEVA + SPINTA</b>									
41SA10LPQ4-EU	1.7 - 4.5	2.8 - 6.8	<b>4.0 - 9.0</b>	1000	1.20	277	20	1/4	790
41SA8LPQ4-EU	1.7 - 4.5	2.8 - 6.8	<b>4.0 - 11.3</b>	800	1.20	277	20	1/4	790
<b>DC PUSH START — DEM. PAR POUSÉE — SCHUBSTART — ARRANQUE POR EMPUJE — AVVIAMENTO A SPINTA</b>									
41SA17PSQ4-EU	1.7 - 4.5	<b>2.8 - 6.8</b>	—	1700	1.20	277	20	1/4	790
41SA10PSQ4-EU	1.7 - 4.5	2.8 - 6.8	<b>4.0 - 9.0</b>	1000	1.20	277	20	1/4	790
41SA8PSQ4-EU	1.7 - 4.5	2.8 - 6.8	<b>4.0 - 11.3</b>	800	1.20	277	20	1/4	790

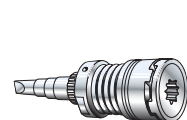

Adjustable cushion clutch models  
 Modèles avec limiteur de couple réglable à billes  
 Modelle mit einstellbarer Rutschkupplung  
 Modelos con embrague ajustable deslizante  
 Modelli con frizione regolabile a cuscinio



**Skinsulate™**  
 Comfort Coating

41SC10LTQ4-EU

Ref.	Nm (1)	Nm (1)	Nm (1)	rpm	kg	mm	mm	in	l/min
<b>DC LEVER START — DÉM. PAR LEVIER — HEBELSTART — ARRANQUE POR PALANCA — AVVIAMENTO A LEVA</b>									
41SC17LTQ4-EU	1.1 - 4.5	<b>1.7 - 6.8</b>	—	1700	1.40	277	20	1/4	565
41SC10LTQ4-EU	1.1 - 4.5	<b>1.7 - 9.0</b>	—	1000	1.40	277	20	1/4	565
<b>DC PUSH START — DEM. PAR POUSÉE — SCHUBSTART — ARRANQUE POR EMPUJE — AVVIAMENTO A SPINTA</b>									
41SC25PSQ4-EU	1.1 - 4.5	—	—	2500	1.30	264	20	1/4	565
41SC10PSQ4-EU	1.1 - 4.5	<b>1.7 - 9.0</b>	—	1000	1.40	277	20	1/4	565

Series / Baureihe			
41	78 dBa	1/4" NPT	8 mm

(1) The torque range indicated in bold letter corresponds to the spring installed on the tool.  
 (1) La gamme de couple indiquée en gras correspond au ressort monté sur la machine.  
 (1) Kupplungsfedern werden mitgeliefert, fett gedruckte Drehmomentangaben gelten für werkseitig eingebaute Feder.  
 (1) La gama de par en negrita corresponde con el muelle instalado en la herramienta.  
 (1) La molla indicata in grossetto corrisponde a quella montata sulla macchina.

Medium & Heavy Assembly Tools  
Outils d'assemblage moyens et lourds  
Mittlere und schwere Montagewerkzeuge  
Intermedio y constantemente montaje herramientas  
Medie e forte montaggio utensili

5 to 9  
Series



Standard  
Equipment

Clutch  
spring(s)

Dead handle  
on model  
7RANP1-EU

Ressort(s)  
de limiteur

Poignée auxiliaire  
(modèle  
7RANP1-EU)

Kupplungs-  
federn

Hilfsgriff  
(Modell  
7RANP1-EU)

Muelles de  
embrague

Mango de  
sujeción (mod.  
7RANP1-EU)

Molle della  
frizione

Impugnatura  
ausiliaria (mod.  
7RANP1-EU)

Specifications at 90 psi – Caractéristiques à 620 kPa  
Technische Daten bezogen auf 620 kPa  
Especificaciones a 620 kPa – Caratteristiche a 620 kPa

Pistol Grip Screwdrivers  
Visseuses à Poignée Révolver  
Drehschrauber mit Pistolengriff  
Atornilladores con Empuñadura de Pistola  
Cacciaviti con Impugnatura a Pistola



7RAMC1-EU

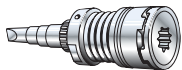

Adjustable cushion clutch models — Modèles avec limiteur de couple réglable à billes — Modelle mit einstellbarer Rutschkupplung — Modelos con embrague ajustable deslizante — Modelli con frizione regolabile a cuscinio

Ref.	Nm <sup>(1)</sup>	Nm <sup>(1)</sup>	1 min. rpm	kg	mm	mm	in	l/min
<b>DC TRIGGER START — DÉM. PAR GÂCHETTE — DRÜCKERSTART — ARRANQUE POR GATILLO — AVVIAMENTO A GRILLETTO</b>								
5RANC1-EU	<b>1.5 - 6.2</b>	6.2 - 8.0	900	1.30	241	21	1/4	480
7RAMC1-EU	<b>2.3 - 9.7</b>	2.9 - 12.5	1000	1.50	268	22	1/4	760

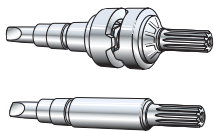

Positive jaw clutch and direct drive models  
A limiteur de couple à clabots ou entraînement direct  
Mit nicht einstellbarer Klauenkupplung oder mit Direktantrieb  
Modelos con embrague positivo o accionamiento directo  
Modelli con frizione a ganasce oblique o trasmissione diretta



5RALD1-EU

Ref.	Nm		1 min. rpm	kg	mm	mm	in	l/min
<b>POSITIVE JAW CLUTCH — EMBRAYAGE À CLABOTS — KLAUENKUPPLUNG — EMBRAGUE POSITIVO — FRIZIONE A GANASCE OBLIQUE</b>								
<b>DC TRIGGER START — DÉM. PAR GÂCHETTE — DRÜCKERSTART — ARRANQUE POR GATILLO — AVVIAMENTO A GRILLETTO</b>								
5RANP1-EU	8.0	M4 - M6	900	1.0	203	21	1/4	480
7RAMP1-EU	13.1	M5 - M6	1000	1.4	237	22	1/4	760
7RANP1-EU	18.8	M8	700	1.4	237	22	1/4	760
<b>DIRECT DRIVE — ENTRAINEMENT DIRECT — DIREKTANTRIEB — ACCIONAMIENTO DIRECTO — TRASMISSIONE DIRETTA</b>								
<b>DC TRIGGER START — DÉM. PAR GÂCHETTE — DRÜCKERSTART — ARRANQUE POR GATILLO — AVVIAMENTO A GRILLETTO</b>								
5RALD1-EU	4.0	M4	2000	0.85	184	21	1/4	480
5RAND1-EU	8.0	M6	900	0.95	203	21	1/4	480

Series / Baureihe			
5	75 dBa	1/4" NPT	6 mm
7	79 dBa	1/4" NPT	8 mm

(1) The torque range indicated in bold letter corresponds to the spring installed on the tool.  
(1) La gamme de couple indiquée en gras correspond au ressort monté sur la machine.  
(1) Kupplungsfedern werden mitgeliefert, fett gedruckte Drehmomentangaben gelten für werksseitig eingebaute Feder  
(1) La gama de par en negrita corresponde con el muelle instalado en la herramienta.  
(1) La molla indicata in grassetto corrisponde a quella montata sulla macchina.

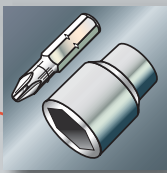

**5 to 9  
Series**

**Medium & Heavy Assembly Tools**  
**Outils d'assemblage moyens et lourds**  
**Mittlere und schwere Montagewerkzeuge**  
**Intermedio y constantemente montaje herramientas**  
**Medie e forte montaggio utensili**

**Standard  
Equipment**

Clutch spring(s)  
(models  
with clutch)

Horizontal  
hanger  
on Series 5  
and 7

Ressort(s)  
de limiteur  
(modèles à  
limiteur)

Suspension  
horizontale sur  
séries 5 et 7

Kupplungs-  
federn (Modelle  
mit Einstellbare  
Kupplung)

Horizontal-  
Aufhänger für  
Baureihen 5  
und 7

Muelles de  
embrague  
(mod. con  
embrague)

Suspensión  
horizontal para  
series 5 y 7

Molle della  
frizione (mod.  
con frizione  
regolabile)

Dispositivo  
sospensione  
orizzontale  
(serie 5 e 7)

Specifications at 90 psi – Caractéristiques à 620 kPa – Technische Daten bezogen auf 620 kPa  
 Especificaciones a 620 kPa – Caratteristiche a 620 kPa

**Angle Wrenches • Clés d'Angle • Winkelschrauber • Llaves Angulares • Chiavi ad Angolo**

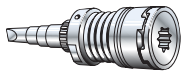

Adjustable cushion clutch models  
 Modèles avec limiteur de couple réglable à billes  
 Modelle mit einstellbarer Rutschkupplung  
 Modelos con embrague ajustable deslizante  
 Modelli con frizione regolabile a cuscinio



7RL2C6-EU



Ref.									
	Nm	Nm	rpm	kg	mm	mm	mm	in	l/min
<b>DC LEVER START — DÉM. PAR LEVIER — HEBELSTART — ARRANQUE POR PALANCA — AVVIAMENTO A LEVA</b>									
7RL2C6-EU	–	<b>1.7 - 11.3</b>	1400	1.50	335	13	33	3/8 □	760
5RLN2C6-EU	<b>1.7 - 9.1</b>	5.7 - 12.5	600	1.50	334	13	33	3/8 □	480
7RL3C6-EU	–	<b>2.8 - 12.5</b>	1400	2.20	363	18	38	3/8 □	760
7RLM3C6-EU	–	<b>2.8 - 14.8</b>	800	2.30	363	18	38	3/8 □	760





Direct drive models  
 Modèles à entraînement direct  
 Modelle mit Direktantrieb  
 Modelos con accionamiento directo  
 Modelli a trasmissione diretta



9RSQ83-EU

Ref.									
	Nm		rpm	kg	mm	mm	mm	in	l/min
<b>DC LEVER START — DÉM. PAR LEVIER — HEBELSTART — ARRANQUE POR PALANCA — AVVIAMENTO A LEVA</b>									
5RLN2D6-EU	12.5	M6	600	1.40	276	13	33	3/8 □	480
7RLM2D6-EU	19.8	M8	800	1.40	286	13	33	3/8 □	760
7RLM3D6-EU	19.8	M6	800	1.60	295	18	38	3/8 □	760
7RLN3D6-EU	29.9	M8	500	1.60	295	18	38	3/8 □	760
9RSQ83-EU	111.5	M14	300	3.50	454	25	46	1/2 □	1850

Series / Baureihe			
5	75 dBa	1/4" NPT	6 mm
7	79 dBa	1/4" NPT	8 mm
9	82 dBa	1/2" NPT	13 mm



Standard  
 Equipment

Horizontal  
 hanger

Suspension  
 horizontale

Horizontal-  
 Aufhänger

Suspensión  
 horizontal

Dispositivo  
 sospensione  
 orizzontale

Specifications at 90 psi – Caractéristiques à 620 kPa – Technische Daten bezogen auf 620 kPa  
 Especificaciones a 620 kPa – Caratteristiche a 620 kPa



See our Qualifier for pneumatic tools page 52  
 Voir notre Boîtier d'Assistance Qualité  
 pour outils pneumatiques page 52  
 Qualifikator für Druckluftwerkzeuge, Seite 52  
 Ver nuestro Cualificador de Procesos  
 para Herramientas Neumáticas página 52  
 Vedere il nostro Qualificatore di Processo  
 per Utensili Pneumatici pag. 52

### Options

Ref. LDX2XXRPX-XX-DI

- Dual information kit<sup>(1)</sup>
- Kit prise d'info<sup>(1)</sup>
- 2-fach Signal<sup>(1)</sup>
- Doble señal<sup>(1)</sup>
- Doppia informazione<sup>(1)</sup>

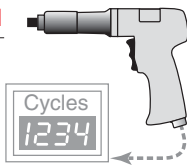

Pistol Grip Screwdrivers  
 Visseuses à Poignée Révolver  
 Drehschrauber mit Pistolengriff  
 Atornilladores con Empuñadura de Pistola  
 Cacciaviti con Impugnatura a Pistola

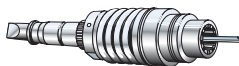

Adjustable shut-off clutch models — Modèles avec limiteur de couple réglable à coupure d'air — Modelle mit einstellbarer Abschaltkupplung — Modelos con parada automática — Modelli con frizione regolabile con blocco aria

Ref.	Nm	1 min. rpm	kg	mm	mm	in	l/min
<b>TRIGGER START — DÉM. PAR GÂCHETTE — DRÜCKERSTART — ARRANQUE POR GATILLO — AVVIAMENTO A GRILLETTO</b>							
LD1207RP5-Q4-RM	0.6 - 1.6	900	1.0	210	20	1/4	465
LD1214RP5-Q4	1.0 - 2.5	1700	1.0	220	20	1/4	430
LD2216RP5-Q4	1.8 - 3.8	1600	1.2	250	20	1/4	520
LD1207RP5-Q4	1.6 - 4.5	900	1.0	210	20	1/4	465
LD2210RP5-Q4	2.1 - 5.7	1000	1.2	231	20	1/4	520
LD1202RP5-Q4	2.4 - 9.2	190	1.1	230	20	1/4	465
LD2206RP5-Q4	2.3 - 9.3	600	1.2	250	20	1/4	575
LD2203RP5-S6	10 - 15	300	1.3	271	20	3/8	520

LD12	70 dBa	1/4" BSP	9 mm
LD22	78 dBa	1/4" BSP	13 mm

- (1) For dual information kit, add "-DI" to tool model no. (e.g. LD2216RP5-Q4-DI).
- (1) Pour kit prise d'info, ajouter "-DI" à la référence (exemple LD2216RP5-Q4-DI).
- (1) 2-fach Signal: ergänzen Sie die Modell-Nr. mit "-DI" (z. B. LD2216RP5-Q4-DI).
- (1) Para doble señal, añadir "-DI" a la referencia (ejemplo LD2216RP5-Q4-DI).
- (1) Per doppia informazione, aggiungere "-DI" al codice del modello (es. LD2216RP5-Q4-DI).

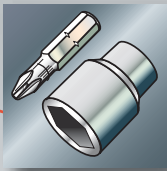

**LD  
Series**

**Precision Fastening Tools  
Visseuses de précision  
Präzisions-Abschalterschrauber  
Llaves de precisión  
Avvitatori di precisione**

**Standard  
Equipment**

Vertical  
hanger

Suspension  
verticale

Vertikal-  
Aufhänger

Suspensión  
vertical

Dispositivo  
sospensione  
verticale

Specifications at 90 psi – Caractéristiques à 620 kPa – Technische Daten bezogen auf 620 kPa – Especificaciones a 620 kPa – Caratteristiche a 620 kPa

**Options**

Ref. LDX2XXRDX-XX-DI

Dual information kit <sup>(1)</sup>

Kit prise d'info <sup>(1)</sup>

2-fach Signal <sup>(1)</sup>

Doble señal <sup>(1)</sup>

Doppia informazione <sup>(1)</sup>

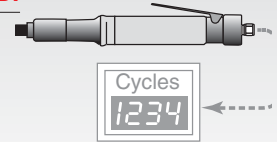

LD1207RD5-Q4







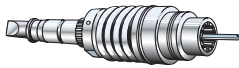

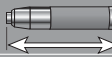

LD2206RD5-Q4

**Straight Screwdrivers  
Visseuses Droites  
Druckluftdreherschrauber, gerade Ausführung  
Atornilladores con Empuñadura Recta  
Cacciaviti con Impugnatura Diritta**



Adjustable shut-off clutch models — Modèles avec limiteur de couple réglable à coupure d'air — Modelle mit einstellbarer Abschaltkupplung — Modelos con parada automática — Modelli con frizione regolabile con blocco aria

Ref.	 Nm	 1 min. rpm	 kg	 mm	 mm	 in	 l/min
<b>DC LEVER START — DÉM. PAR LEVIER — HEBELSTART — ARRANQUE POR PALANCA — AVVIAMENTO A LEVA</b>							
LD1214RD5-Q4	1.1 - 2.5	1500	0.7	231	17	1/4	460
LD1207RD5-Q4	1.2 - 4.2	800	0.7	231	17	1/4	460
LD2216RD5-Q4	1.8 - 4.5	1550	1.0	272	18	1/4	620
LD2210RD5-Q4	2.4 - 5.9	1000	1.0	272	18	1/4	620
LD2206RD5-Q4	2.1 - 9.8	600	1.0	272	18	1/4	620
LD1202RD5-Q4	1.6 - 10	180	0.8	243	17	1/4	460
LD2203RD5-S6	10 - 15	300	1.1	293	18	3/8	620
<b>DC PUSH START — DEM. PAR POUSSÉE — SCHUBSTART — ARRANQUE POR EMPUJE — AVVIAMENTO A SPINTA</b>							
LD1214RD3-Q4	1.1 - 2.5	1500	0.7	231	17	1/4	460
LD1207RD3-Q4	1.2 - 4.2	800	0.7	231	17	1/4	460
LD2216RD3-Q4	1.8 - 4.5	1550	1.0	272	18	1/4	620
LD2210RD3-Q4	2.4 - 5.9	1000	1.0	272	18	1/4	620
LD2206RD3-Q4	2.1 - 9.8	600	1.0	272	18	1/4	620
LD1202RD3-Q4	1.6 - 10	180	0.8	243	17	1/4	460

Series / Baureihe			
LD12	70 dBa	1/4" BSP	9 mm
LD22	72 dBa	1/4" BSP	13 mm

(1) For dual information kit, add "-DI" to tool model no. (e.g. LD2216RD5-Q4-DI).

(1) Pour kit prise d'info, ajouter "-DI" à la référence (exemple LD2216RD5-Q4-DI).

(1) 2-fach Signal: ergänzen Sie die Modell-Nr. mit "-DI" (z. B. LD2216RD5-Q4-DI).

(1) Para doble señal, añadir "-DI" a la referencia (ejemplo LD2216RD5-Q4-DI).

(1) Per doppia informazione, aggiungere "-DI" al codice del modello (es. LD2216RD5-Q4-DI).





**Standard**  
 Equipment

Vertical  
 hanger

Suspension  
 verticale

Vertikal-  
 Aufhänger

Suspensión  
 vertical

Dispositivo  
 sospensione  
 verticale

Specifications at 90 psi – Caractéristiques à 620 kPa – Technische Daten bezogen auf 620 kPa  
 Especificaciones a 620 kPa – Caratteristiche a 620 kPa

**Options**

Ref. BALDX2XXRDX-XXX-XX-DI

Dual information kit<sup>(1)</sup>

Kit prise d'info<sup>(1)</sup>

2-fach Signal<sup>(1)</sup>

Doble señal<sup>(1)</sup>

Doppia informazione<sup>(1)</sup>

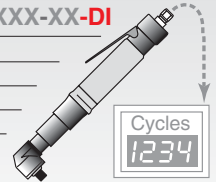

**Angle Wrenches**  
 Clés d'Angle  
 Winkelschrauber  
 Llaves Angulares  
 Chiavi ad Angolo



BALD1207RD5-R25-H4



BALD2206RD5-R25-S6

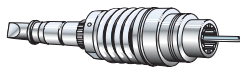

Adjustable shut-off clutch models — Modèles avec limiteur de couple réglable à coupure d'air — Modelle mit einstellbarer Abschaltkupplung — Modelos con parada automática — Modelli con frizione regolabile con blocco aria

Ref.	Nm	1 min. rpm	kg	mm	mm	mm	in	l/min
<b>IR LEVER START — DÉM. PAR LEVIER — HEBELSTART — ARRANQUE POR PALANCA — AVVIAMENTO A LEVA</b>								
BALD1202RD5-R18-S4-RM	1.0-2.0	140	1.0	315	9.2	23	1/4	460
BALD1214RD5-R25-H4	1.4-4.0	1200	1.0	284	12.5	31	1/4	460
BALD1207RD5-R18-S4	1.8-4.9	650	1.0	303	9.2	23	1/4	460
BALD1207RD5-R25-H4	1.4-5.7	650	1.0	275	12.5	31	1/4	460
BALD1207RD5-R25-S4	1.4-5.7	650	1.0	275	12.5	31	1/4	460
BALD1207RD5-R25-S6	1.4-5.7	650	1.0	275	12.5	31	3/8	460
BALD2210RD5-R25-S6	3.2-7.5	900	1.3	314	12.5	31	3/8	645
BALD1202RD5-R18-S4	2.6-9.0	140	1.0	315	9.2	23	1/4	460
BALD1202RD5-R25-H4	2.6-9.4	140	1.0	287	12.5	31	1/4	460
BALD2206RD5-R25-H4	2.2-12	560	1.3	314	12.5	31	1/4	645
BALD2206RD5-R25-S4	2.2-12	560	1.3	314	12.5	31	1/4	645
BALD2206RD5-R25-S6	2.2-12	560	1.3	314	12.5	31	3/8	645
BALD2203RD5-R28-S6	2.8-31	170	1.8	399	14.0	32	3/8	645

Series / Baureihe			
BALD12	79 dBa	1/4" BSP	9 mm
BALD22	78 dBa	1/4" BSP	13 mm

(1) For dual information kit, add "-DI" to tool model no. (e.g. BALD2206RD5-R25-S6-DI).  
 (1) Pour kit prise d'info, ajouter "-DI" à la référence (exemple BALD2206RD5-R25-S6-DI).  
 (1) 2-fach Signal: ergänzen Sie die Modell-Nr. mit "-DI" (z. B. BALD2206RD5-R25-S6-DI).  
 (1) Para doble señal, añadir "-DI" a la referencia (ejemplo BALD2206RD5-R25-S6-DI).  
 (1) Per doppia informazione, aggiungere "-DI" al codice del modello (es. BALD2206RD5-R25-S6-DI).



**QA  
Series**

**Precision Fastening Tools**  
**Visseuses de précision**  
**Präzisions-Abschalterschrauber**  
**Llaves de precisión**  
**Avvitatori di precisione**

**Standard  
Equipment**

**Lube free  
motor**

**Vertical  
hanger**

Moteur  
non lubrifié

Suspension  
verticale

Ölfreier Motor

Vertikal-  
Aufhänger

Motor sin  
lubricación

Suspensión  
vertical

Motore senza  
lubrificazione

Dispositivo  
Dispositivo  
sospensione  
verticale



Specifications at 90 psi – Caractéristiques à 620 kPa – Technische Daten bezogen auf 620 kPa  
 Especificaciones a 620 kPa – Caratteristiche a 620 kPa



QA4ASLS020BP20S06





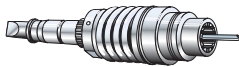

**Straight Screwdrivers**  
**Visseuses Droites**  
**Druckluftdreherschrauber, gerade Ausführung**  
**A tornilladores con Empuñadura Recta**  
**Cacciaviti con Impugnatura Diritta**



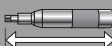

QA6ASLS040BP41S06



Adjustable shut-off clutch models — Modèles avec limiteur de couple réglable à coupure d'air — Modelle mit einstellbarer Abschaltkupplung — Modelos con parada automática — Modelli con frizione regolabile con blocco aria

Ref.	 Nm	 1 min. rpm	 kg	 mm	 mm	 in	 l/min
<b>DC LEVER START — DÉM. PAR LEVIER — HEBELSTART — ARRANQUE POR PALANCA — AVVIAMENTO A LEVA</b>							
QA4ASLS012BP20S04	6-12	1050	1.30	351	21	1/4 □	820
QA4ASLS015BP20S04	7-15	850	1.30	351	21	1/4 □	820
QA4ASLS020BP20S06	10-20	600	1.40	342	21	3/8 □	820
QA4ASLS027BP20S06	14-27	450	1.40	342	21	3/8 □	821
QA4ASLS046BP20S06	20-46	250	1.50	370	23	3/8 □	820
QA6ASLS025BP41S06	12-25	720	2.30	478	20	3/8 □	1020
QA6ASLS030BP41S06	15-30	605	2.30	478	20	3/8 □	1020
QA6ASLS040BP41S06	20-40	450	2.30	478	20	3/8 □	1020
QA6ASLS055BP41S08	25-55	325	2.31	478	20	1/2 □	1020
QA8ASLS040BP41S06	20-40	600	2.39	502	20	3/8 □	1300
QA8ASLS055BP41S08	25-55	470	2.40	502	20	1/2 □	1300
QA8ASLS070BP41S08	35-70	355	2.54	506	24	1/2 □	1300
QA8ASLS090BP41S08	45-90	255	2.87	542	24	1/2 □	1300
QA8ASLS115BF41S08	70-115	215	3.40	541	51	1/2 □	1300
QA8ASLS150BF41S08	75-150	165	3.40	541	51	1/2 □	1300

Series / Baureihe			
QA4	79 dBa	1/4 BSP	10 mm
QA6	82 dBa	3/8 BSP	13 mm
QA8	87 dBa	3/8 BSP	13 mm



\* See QA Series specific accessories page 58.  
 \* Accessoires spécifiques à la série QA présentés en page 58.  
 \* Zubehör für QA auf Seite 58.  
 \* Accesorios específicos a la serie QA en pagina 58.  
 \* Gli accessori specifici per la serie QA vedere a pagina 58.

Precision Fastening Tools  
 Visseuses de précision  
 Präzisions-Abschalterschrauber  
 Llaves de precisión  
 Avvitatori di precisione

QA  
 Series



Standard  
 Equipment

Lube free  
 motor  
 Horizontal  
 hanger

Moteur  
 non lubrifié  
 Suspension  
 horizontale

Ölfreier Motor  
 Horizontal-  
 Aufhänger

Motor sin  
 lubricación  
 Suspensión  
 horizontal

Motore senza  
 lubrificazione  
 Dispositivo  
 sospensione  
 orizzontale



Specifications at 90 psi – Caractéristiques à 620 kPa – Technische Daten bezogen auf 620 kPa  
 Especificaciones a 620 kPa – Caratteristiche a 620 kPa





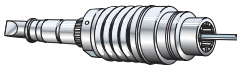

Angle Wrenches  
 Clés d'Angle  
 Winkelschrauber  
 Llaves Angulares  
 Chiavi ad Angolo



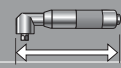

4



Adjustable shut-off clutch models — Modèles avec limiteur de couple réglable à coupure d'air — Modelle mit einstellbarer Abschaltkupplung — Modelos con parada automática — Modelli con frizione regolabile con blocco aria

Ref.	 Nm	 1 min. rpm	 kg	 mm	 mm	 mm	 in	 l/min
<b>IR LEVER START — DÉM. PAR LEVIER — HEBELSTART — ARRANQUE POR PALANCA — AVVIAMENTO A LEVA</b>								
QA4AALS011BP25S06	5-11	1025	1.44	342	33	13	3/8	765
QA4AALS015BP25S06	7-15	800	1.44	342	33	13	3/8	765
QA4AALS020BP25S06	10-20	625	1.44	342	33	13	3/8	765
QA4AALS030BP28S06	15-30	425	1.52	363	35	14	3/8	765
QA4AALS040BP35S06	20-40	325	1.81	395	44	18	3/8	765
QA4AALS055BP35S08	25-55	200	2.04	418	44	18	1/2	765
QA6AALS030BP35S06	15-30	580	2.29	429	44	18	3/8	1020
QA6AALS040BP35S06	20-40	430	2.29	429	44	18	3/8	1020
QA6AALS055BP35S08	25-55	320	2.30	429	44	18	1/2	1020
QA6AALS070BP43S08	35-70	225	2.30	422	45	22	1/2	1020
QA6AALS090BP43S08	45-90	185	2.30	422	45	22	1/2	1020
QA8AALS040BP35S06	20-40	570	2.44	453	44	18	3/8	1300
QA8AALS055BP35S08	25-55	425	2.45	453	44	18	1/2	1300
QA8AALS070BP43S08	35-70	320	2.45	445	45	22	1/2	1300
QA8AALS090BP43S08	45-90	255	2.45	445	45	22	1/2	1300
QA8AALS115BP48S08	70-115	200	2.79	452	50	25	1/2	1300
QA8AALS150BP48S08	75-150	145	3.12	489	50	25	1/2	1300
QA8AALS200BF56S12	100-200	110	4.02	508	53	30	3/4	1300
QA8AALS225BF56S12	125-225	90	4.02	508	53	30	3/4	1300

Series / Baureihe			
QA4	79 dBa	1/4 BSP	10 mm
QA6	82 dBa	3/8 BSP	13 mm
QA8	87 dBa	3/8 BSP	13 mm

\* See QA Series specific accessories page 58.

\* Accessoires spécifiques à la série QA présentés en page 58.

\* Zubehör für QA auf Seite 58.

\* Accesorios específicos a la serie QA en pagina 58.

\* Gli accessori specifici per la serie QA vedere a pagina 58.

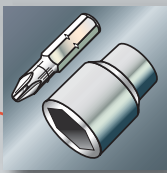

**QA Series**

**Precision Fastening Tools**  
**Visseuses de précision**  
**Präzisions-Abschalterschrauber**  
**Llaves de precisión**  
**Avvitatori di precisione**

**Standard Equipment**

Lube free motor

Data collection output for cycle counting

Double axial inlet

19 mm adjustable floating spindle

Moteur non lubrifié

Prise d'info. pour comptage de cycles

Double alimentation axiale

Broche télescopique réglable 19 mm

Ölfreier Motor

Verschraubungszähler

Doppelter Lufteinlass

Einstellbare Gleitspindel (19 mm)

Motor sin lubricación

Salida para conteo de ciclos

Doble entrada de aire en línea

Husillo telescópico (19 mm)

Motore senza lubrificazione

Presse segnale per conteggio cicli

Doppia alimentazione assiale

Albero telescopico regolabile (19 mm)



Connection  
 Connexion  
 Anschluss  
 Conexión  
 Attacco

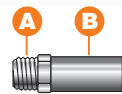

Specifications at 90 psi – Caractéristiques à 620 kPa – Technische Daten bezogen auf 620 kPa  
 Especificaciones a 620 kPa – Caratteristiche a 620 kPa

**Fixtured Wrenches**  
**Broches de Vissage**  
**Einbau-Druckluftschrauber**  
**Husillos de Atornillado**  
**Chiavi per Installazioni Fisse**



QA8ASRS090BF41S08

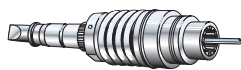
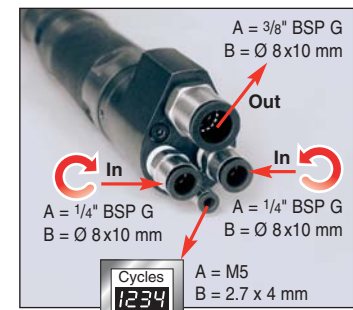

Adjustable shut-off clutch models — Modèles avec limiteur de couple réglable à coupure d'air — Modelle mit einstellbarer Abschaltkupplung — Modelos con parada automática — Modelli con frizione regolabile con blocco aria

Ref.							
	Nm	rpm	kg	mm	mm	in	l/min
<b>DC LEVER START — DÉM. PAR LEVIER — HEBELSTART — ARRANQUE POR PALANCA — AVVIAMENTO A LEVA</b>							
QA4ASRS012BF41S06	6-12	1050	1.30	451	21	3/8	820
QA4ASRS015BF41S06	7-15	850	1.30	451	21	3/8	820
QA4ASRS020BF41S06	10-20	600	1.40	451	21	3/8	820
QA4ASRS027BF41S06	14-27	450	1.40	451	21	3/8	820
QA4ASRS046BF41S06	20-46	250	1.50	465	23	3/8	820
QA6ASRS025BF41S06	12-25	700	2.61	454	34	3/8	1020
QA6ASRS030BF41S06	15-30	585	2.61	454	34	3/8	1020
QA6ASRS040BF41S06	20-40	435	2.61	454	34	3/8	1020
QA6ASRS055BF41S08	25-55	315	2.62	454	34	1/2	1020
QA8ASRS040BF41S06	20-40	540	2.73	478	34	3/8	1300
QA8ASRS055BF41S08	25-55	425	2.74	478	34	1/2	1300
QA8ASRS070BF41S08	35-70	320	3.09	482	43	1/2	1300
QA8ASRS090BF41S08	45-90	230	3.42	518	43	1/2	1300
QA8ASRS115BF41S08	70-115	195	3.64	517	51	1/2	1300
QA8ASRS180BF41S08	90-180	125	3.64	517	51	1/2	1300

Series / Baureihe			
QA4	79 dBa	1/4 BSP	10 mm
QA6	82 dBa	3/8 BSP	13 mm
QA8	87 dBa	3/8 BSP	13 mm



Fixtured Angle Wrenches also available: Please consult our Solutions Center.  
 Pour les broches de vissage d'angle, consulter notre Centre d'Applications.  
 Einbauspindeln mit Winkelkopf: konsultieren Sie unsere Solutions Center.  
 Llaves angulares fijas: Póngase en contacto con su Solutions Center.  
 Chiavi ad angolo per installazioni fisse: contattare il Solutions Center.

Air pulse Nutrunners / Screwdrivers  
Clés hydro-pneumatiques  
Impulsschrauber  
Aprieturcas y atornilladores de impulso  
Chiavi ad impulso idraulico e cacciaviti

Power  
Pulse



Standard  
Equipment

Torque  
adjusting  
wrench

Vertical hanger  
on models  
100, 180, 280  
and 380

Clé de réglage  
de couple

Suspension  
verticale sur  
modèles 100,  
180, 280 et  
380

Drehmoment-  
Einstellschlüssel

Vertikal-  
Aufhänger für  
Modelle 100,  
180, 280 und  
380

Llave para  
ajustar el par

Suspensión  
vertical para  
modelos  
100, 180,  
280 y 380

Chiave per  
regolazione  
della coppia

Dispositivo  
sospensione  
verticale per  
modelli 100,  
180, 280 y 380



See our Qualifier for pneumatic tools page 52

Voir notre Boîtier d'Assistance Qualité  
pour outils pneumatiques page 52

Qualifikator für Druckluftwerkzeuge, Seite 52

Ver nuestro Cualificador de Procesos  
para Herramientas Neumáticas página 52

Vedere il nostro Qualificatore di Processo  
per Utensili Pneumatici pag. 52

Specifications at 90 psi – Caractéristiques à 620 kPa – Technische Daten bezogen auf 620 kPa  
Especificaciones a 620 kPa – Caratteristiche a 620 kPa



180SQ1-EU



280P-EU



700P-EU







Non shut-off models

Modèles sans coupure d'air automatique

Modelle ohne Abschaltventil

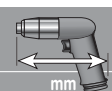
Modelos sin parada automática

Modelli senza valvola di blocco

Ref.	 Nm	 rpm	 kg	 mm	 mm	 in	 l/min
<b>IR PISTOL GRIP — POIGNÉE RÉVOLVER — PISTOLENGRIFF — EMPUÑADURA DE PISTOLA — IMPUGNATURA A PISTOLA</b>							
100PQ1-EU	4 - 11	9 500	0.70	142	18	1/4	220
180PQ1-EU	18 - 30	10 500	1.00	165	23	1/4	250
280P-EU	25 - 38	10 500	1.10	178	23	3/8	310
380P-EU	34 - 47	10 000	1.30	178	25	3/8	310
500P-EU	31 - 55	8 200	1.40	165	31	3/8	340
700P-EU	45 - 78	8 000	1.60	165	31	3/8	390
900P-EU	70 - 111	6 500	2.10	201	33	1/2	390
1100P-EU	85 - 123	4 700	2.20	208	36	1/2	450
<b>IR STRAIGHT HANDLE — POIGNÉE DROITE — GERADE AUSFUHRUNG — EMPUÑADURA RECTA — IMPUGNATURA DIRITTA</b>							
100SQ1-EU	6 - 12	9 500	0.80	226	21	1/4	250
180SQ1-EU	18 - 30	10 500	0.90	221	23	1/4	250
280SQ1-EU	20 - 34	10 500	0.90	229	23	1/4	310
380SQ1-EU	29 - 44	10 000	1.20	231	25	1/4	310
<b>IR ANGLE HEAD — A RENVOI D'ANGLE — WINKELKOPF — CABEZA ANGULAR — TESTA AD ANGOLO</b>							
500A-EU	30 - 45	7 500	1.50	267	28	3/8	340
700A-EU	36 - 50	5 000	2.00	284	28	3/8	340

Series /  
Baureihe



100P → 1100P

76 → 78 dBa

1/4" NPT

10 mm

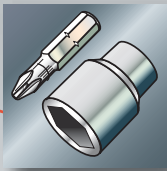

**Power  
Pulse**

**Air pulse Nutrunners / Screwdrivers**  
**Clés hydro-pneumatiques**  
**Impulsschrauber**  
**Aprieturcas y atornilladores de impulso**  
**Chiavi ad impulso idraulico e cacciaviti**

**Standard  
Equipment**

Torque  
adjusting  
wrench

Clé de réglage  
de couple

Drehmoment-  
Einstellschlüssel

Llave para  
ajustar el par

Chiave per  
regolazione  
della coppia

Specifications at 90 psi – Caractéristiques à 620 kPa – Technische Daten bezogen auf 620 kPa  
 Especificaciones a 620 kPa – Caratteristiche a 620 kPa



See our Qualifier for pneumatic tools page 52

Voir notre Boîtier d'Assistance Qualité  
pour outils pneumatiques page 52

Qualifikator für Druckluftwerkzeuge, Seite 52

Ver nuestro Cualificador de Procesos  
para Herramientas Neumáticas página 52

Vedere il nostro Qualificatore di Processo  
per Utensili Pneumatici pag. 52



500PS3-EU

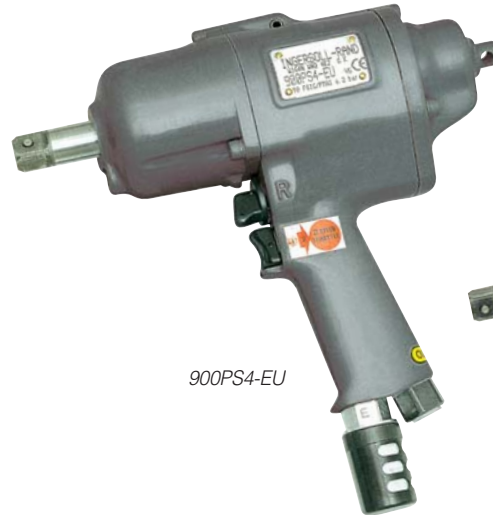











900PS4-EU



1100PS4-EU

**Shut-off models**  
**Modèles à coupure d'air automatique**  
**Modelle mit Abschaltventil**  
**Modelos con parada automática**  
**Modelli con valvola di blocco**

Ref.	 Nm	 1 min. rpm	 kg	 mm	 mm	 in	 l/min
<b>DC PISTOL GRIP — POIGNÉE RÉVOLVER — PISTOLENGRIFF — EMPUÑADURA DE PISTOLA — IMPUGNATURA A PISTOLA</b>							
500PS3-EU	30 - 50	8 200	1.8	201	31	3/8	340
700PS3-EU	45 - 70	8 000	2.1	216	31	3/8	390
900PS4-EU	65 - 100	6 500	2.7	231	33	1/2	395
1100PS4-EU	80 - 110	4 700	2.8	234	33	1/2	450
1900PS4-EU	100 - 160	5 800	3.9	259	38	1/2	500

Series / Baureihe			
500PS3 → 1900PS4	76 → 82 dBa	1/4" NPT	10 mm

Air pulse Nutrunners / Screwdrivers  
Clés hydro-pneumatiques  
Impulsschrauber  
Aprietueras y atornilladores de impulso  
Chiavi ad impulso idraulico e cacciaviti

Power  
Pulse  
PLUS



Standard  
Equipment

Torque  
adjusting  
wrench

Lube free  
motor on  
"Q" and "QS"  
models

Clé de réglage  
de couple

Moteur non  
lubrifié sur  
modèles  
"Q" et "QS"

Drehmoment-  
Einstellschlüssel

Ölfreier  
Motor für  
Modelle  
"Q" & "QS"

Llave para  
ajustar el par

Motor sin  
lubricación  
para modelos  
"Q" y "QS"

Chiave per  
regolazione  
della coppia

Motore senza  
lubrificazione  
per modelli  
"Q" e "QS"

Specifications at 90 psi – Caractéristiques à 620 kPa – Technische Daten bezogen auf 620 kPa  
Especificaciones a 620 kPa – Caratteristiche a 620 kPa



4

Ref.	Nm	1 min. rpm	kg	mm	mm	in	l/min
<b>NON SHUT-OFF — SANS COUPE D'AIR — OHNE ABSCHALTUNG — SIN PARADA AUTOMÁTICA — SENZA BLOCCO</b>							
46PQ1	16-26	8000	0.90	142	22	1/4	340
46P3	16-30	8000	0.90	142	22	3/8	340
100P4	100-145	5000	2.0	188	33	1/2	580
130P4	140-220	3500	2.5	201	34	1/2	700
140P6	160-270	3300	3.2	226	36	3/4	700
<b>NON SHUT-OFF — SANS COUPE D'AIR — OHNE ABSCHALTUNG — SIN PARADA AUTOMÁTICA — SENZA BLOCCO</b>							
Q70PQ1	20-28	7000	0.80	131	21	1/4	330
Q70P3	24-35	7000	0.80	131	21	3/8	330
Q80PQ1	24-35	7000	0.85	138	21	1/4	350
Q80P3	33-50	7000	0.85	138	21	3/8	350
Q90P3	47-65	6500	0.97	148	23	3/8	400
Q110P4	65-100	5500	1.38	164	26	1/2	580
<b>SHUT-OFF — A COUPE D'AIR AUTOMATIQUE — MIT ABSCHALTUNG — PARADA AUTOMÁTICA — CON BLOCCO</b>							
40PSQ1	8-13	6000	0.95	183	21	1/4	340
90PS4	60-90	5000	2.00	201	29	1/2	510
<b>SHUT-OFF — A COUPE D'AIR AUTOMATIQUE — MIT ABSCHALTUNG — PARADA AUTOMÁTICA — CON BLOCCO</b>							
QS60PQ1	6-13	5300	1.00	164	23	1/4	340
QS60P3	7-15.5	5300	1.10	164	23	3/8	340
QS70PQ1	13-28	6800	1.10	177	23	1/4	368
QS70P3	15-32	6800	1.10	177	23	3/8	368
QS80P3	30-55	6800	1.10	187	25	3/8	450

Series / Baureihe			
40P → 90P	78 → 82 dBa	1/4" NPT	10 mm
100P → 140P	82 → 83 dBa	1/4" NPT	13 mm

Series / Baureihe			
QS60P	72 dBa	1/4" NPT	10 mm
Q70P, QS70P	74 dBa	1/4" NPT	10 mm
Q80P, QS80P, Q90P	78 dBa	1/4" NPT	10 mm
Q110P	81 dBa	1/4" NPT	10 mm

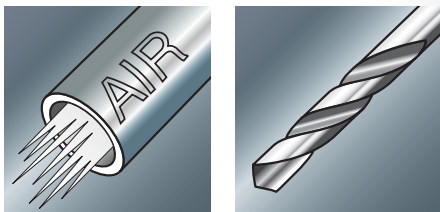

# Air Drills

Perceuses pneumatiques  
 Druckluft-Bohrmaschinen  
 Taladros neumáticos  
 Trapani pneumatici

35

## 1 Series

Production Drills  
 Perceuses de production  
 Bohrmaschinen für Industrieinsatz  
 Taladros para producción  
 Trapani per produzione

36

## Q2 Series

Production Drills  
 Perceuses de production  
 Bohrmaschinen für Industrieinsatz  
 Taladros para producción  
 Trapani per produzione

38

## 5 to 7 Series

Production Drills  
 Perceuses de production  
 Bohrmaschinen für Industrieinsatz  
 Taladros para producción  
 Trapani per produzione

40

## P33 Series

Precision Drills  
 Perceuses de précision  
 Präzisions-Bohrmaschinen  
 Taladros de precisión  
 Trapani di precisione





# Production Drills Selection Chart

## Table de sélection des perceuses de production

## Bohrmaschinen für die Industrie - Auswahltabelle

## Cuadro de selección de taladros para producción

## Tabella di selezione delle trapani per produzione

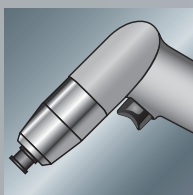

**Pistol grip models**  
**Modèles à poignée révolver**  
**Modelle mit Pistolengriff**  
**Modelos con empuñadura de pistola**  
**Modelli con impugnatura a pistola**

Model No.	RPM	0	5 Nm	10 Nm	15 Nm	20 Nm	25 Nm	30 Nm	Page
<b>1 Series</b>	<b>1AL1</b>	2800	█						35
	<b>1P38ST4</b>	3800	█						35
	<b>1P09ST4</b>	900	█	█					35
	<b>1P06ST4</b>	600	█	█	█				35
<b>Q2 Series</b>	<b>QP512LD</b>	5100	█						36
	<b>QP511LD</b>	5100	█						36
	<b>QP381D</b>	3800	█						36
	<b>QP302LD</b>	3000	█						36
	<b>QP301LD</b>	3000	█						36
	<b>QP202D</b>	2000	█	█					36
	<b>QP201D</b>	2000	█	█					36
	<b>QP152D</b>	1500	█	█					36
	<b>QP151D</b>	1500	█	█					36
	<b>QP091D</b>	900	█	█					36
	<b>QP051D</b>	500	█	█	█				36
<b>5 to 7 Series</b>	<b>7ADST4-EU</b>	20 000	█						38
	<b>5AJST4-EU</b>	4500	█	█					38
	<b>5AKST4-EU</b>	3000	█	█					38
	<b>7AHST4-EU</b>	6000	█	█					38
	<b>5RALST6-EU</b>	2000	█	█					38
	<b>5ALST4-EU</b>	2200	█	█					38
	<b>7AJST4-EU</b>	4800	█	█					38
	<b>7AKST6-EU</b>	3200	█	█					38
	<b>5RANST8-EU</b>	900	█	█	█				38
	<b>7ALST6-EU</b>	2400	█	█	█				38
	<b>5ANST6-EU</b>	1000	█	█	█				38
	<b>7AMST6-EU</b>	1400	█	█	█	█			38
	<b>7ANST8-EU</b>	900	█	█	█	█	█		38
	<b>7AQST8-EU</b>	600	█	█	█	█	█	█	38

5

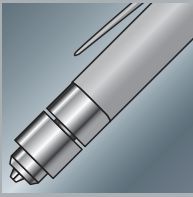

**Straight handle models**  
**Modèles à poignée droite**  
**Modelle in gerader Ausführung**  
**Modelos con empuñadura recta**  
**Modelli con impugnatura diritta**

	Model No.	RPM	0	5 Nm	10 Nm	15 Nm	20 Nm	25 Nm	30 Nm	Page
<b>1 Series</b>	1LL1	2800	■							35
	1S30MF4	3000	■							35
<b>Q2 Series</b>	QS511D	5100	■							36
	QS381D	3800	■							36
	QS301D	3000	■							36
	QS151D	1500	■							36
<b>5 to 7 Series</b>	5LJ1-EU	4800	■							39
	5LK1-EU	3100	■							39
	5LL1-EU	2300	■							39
	5LN3-EU	1050	■							39

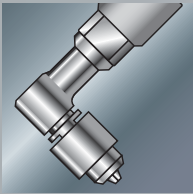

**Angle head models**  
**Modèles d'angle**  
**Modelle mit Winkelkopf**  
**Modelos con cabeza angular**  
**Modelli con testa ad angolo**

	Model No.	RPM	5 Nm	10 Nm	15 Nm	20 Nm	25 Nm	30 Nm	Page
<b>1 Series</b>	1LJ1A1	3700	■						35
	1LL1A1	2700	■						35
<b>Q2 Series</b>	QA2739D	2700	■						37
	QA2759D	2700	■						37
	QA1239D	1270	■						37
	QA0859D	850	■						37
	QA0539D	500	■						37
	QA0559D	500	■						37
<b>5 to 7 Series</b>	5LK1A4-EU	3000	■						39
	5LL1A4-EU	2200	■						39
	5LL2A41-EU	1500	■						39
	5LN2A43-EU	700	■						39
	7LM3A43-EU	900	■						39
	7LN3A44-EU	600	■						39

Production Drills  
Perceuses de production  
Bohrmaschinen für Industrieinsatz  
Taladros para producción  
Trapani per produzione

1  
Series



Standard  
Equipment

Variable speed control

Drill chuck and key

Soft touch, non-slip grip

Contrôle de la vitesse

Mandrin et clé de mandrin

Revêtement anti-dérapant

Variable Geschwindigkeitskontrolle

Bohrfutter und Schlüssel

Weicher, rutschfester Griff

Gatillo de velocidad variable

Portabrocas y llave

Empuñadura suave, antideslizante

Grilletto a velocità variabile

Mandrino e chiave

Impugnatura morbida, antiscivolo

Specifications at 90 psi – Caractéristiques à 620 kPa – Technische Daten bezogen auf 620 kPa  
Especificaciones a 620 kPa – Caratteristiche a 620 kPa



1P38ST4

Pistol grip models  
Modèles à poignée revolver  
Modelle mit Pistolengriff  
Modelos con empuñadura de pistola  
Modelli con impugnatura a pistola

Ref.	1 min. rpm	Max. Nm	kg	mm	Max. mm	in	mm	l/min
<b>C TRIGGER START — DÉM. PAR GÂCHETTE — DRÜCKERSTART — ARRANQUE POR GATILLO — AVVIAMENTO A GRILLETTO</b>								
1P06ST4	600	11.3	0.68	171	6	3/8-24	17	311
1P09ST4	900	7.6	0.68	171	6	3/8-24	17	311
1AL1	2800	1.70	0.65	159	6	3/8-24	16.5	311
1P38ST4	3800	2.30	0.65	159	6	3/8-24	17	311

5

Straight handle models • Modèles à poignée droite  
Modelle in gerader Ausführung • Modelos con empuñadura recta • Modelli con impugnatura diritta



1LL1

Ref.	1 min. rpm	Max. Nm	kg	mm	Max. mm	in	mm	l/min
<b>C LEVER START — DÉM. PAR LEVIER — HEBELSTART — ARRANQUE POR PALANCA — AVVIAMENTO A LEVA</b>								
1LL1	2800	1,70	0,51	194	6	3/8-24	17	311
1S30MF4	3000	1,90	0,54	186	6	3/8-24	16,5	311

Angle head models • Modèles d'angle  
Modelle mit Winkelkopf • Modelos con cabeza angular • Modelli con testa ad angolo

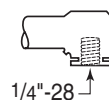

Ref.	1 min. rpm	Max. Nm	kg	mm	Max. mm	mm	mm	l/min
<b>C LEVER START — DÉM. PAR LEVIER — HEBELSTART — ARRANQUE POR PALANCA — AVVIAMENTO A LEVA</b>								
1LL1A1	2700	1.6	0.51	234	—	28	8.5	311
1LJ1A1	3700	1.1	0.51	234	—	28	8.5	311

Series / Baureihe				
1A... 1L...	0.11 kW	73 dBa	1/8" NPT	6 mm
1P... 1S...	0.14 kW	73 dBa	1/4" NPT	6 mm



See drill collets pages 37.  
Pinces présentées page 37.  
Spannzangen für Bohrmaschinen, siehe Seite 37.  
Pinzas para taladros angulares presentadas en página 37.  
Per le pinze per trapani, vedere pagina 37.



**Q2  
Series**

**Production Drills**  
**Perceuses de production**  
**Bohrmaschinen für Industrieinsatz**  
**Taladros para producción**  
**Trapani per produzione**

**Standard  
Equipment**

Variable speed control

Drill chuck and key

Soft touch, non-slip grip

Contrôle de la vitesse

Mandrin et clé de mandrin

Revêtement anti-dérapant

Variable Geschwindigkeitskontrolle

Bohrfutter und Schlüssel

Weicher, rutschfester Griff

Gatillo de velocidad variable

Portabrocas y llave

Empuñadura suave, antideslizante

Grilletto a velocità variabile

Mandrino e chiavetta

Impugnatura morbida, antiscivolo

Specifications at 90 psi – Caractéristiques à 620 kPa – Technische Daten bezogen auf 620 kPa  
 Especificaciones a 620 kPa – Caratteristiche a 620 kPa



QP151D









**Pistol grip models**

Modèles à poignée révolver

Modelle mit Pistolengriff

Modelos con empuñadura de pistola

Modelli con impugnatura a pistola

Ref.	 rpm	 Nm	 kg	 mm	 Max. mm	 in	 mm	 l/min
<b>C TRIGGER START — DÉM. PAR GÂCHETTE — DRÜCKERSTART — ARRANQUE POR GATILLO — AVVIAMENTO A GRILLETTO</b>								
QP051D	500	9.8	0.70	184	6	3/8-24	15	450
QP091D	900	5.8	0.70	184	6	3/8-24	15	450
QP151D	1500	3.4	0.70	184	6	3/8-24	15	450
QP152D	1500	3.4	0.80	184	10	3/8-24	18	450
QP201D	2000	2.8	0.70	184	6	3/8-24	15	450
QP202D	2000	2.8	0.80	184	10	3/8-24	18	450
QP301LD	3000	1.8	0.65	171	6	3/8-24	15	450
QP302LD	3000	1.8	0.75	171	10	3/8-24	18	450
QP381D	3800	1.5	0.70	184	6	3/8-24	15	450
QP511LD	5100	1.1	0.65	171	6	3/8-24	15	450
QP512LD	5100	1.1	0.75	171	10	3/8-24	18	450

**Straight handle models**

Modèles à poignée droite









Modelle in gerader Ausführung

Modelos con empuñadura recta

Modelli con impugnatura diritta



QS151D

Ref.	 rpm	 Nm	 kg	 mm	 Max. mm	 in	 mm	 l/min
<b>C LEVER START — DÉM. PAR LEVIER — HEBELSTART — ARRANQUE POR PALANCA — AVVIAMENTO A LEVA</b>								
QS151D	1500	3.80	0.62	205	6	3/8-24	15	450
QS301D	3000	1.90	0.62	205	6	3/8-24	15	450
QS381D	3800	1.50	0.62	205	6	3/8-24	15	450
QS511D	5100	1.20	0.62	205	6	3/8-24	15	450

Production Drills  
Perceuses de production  
Bohrmaschinen für Industrieinsatz  
Taladros para producción  
Trapani per produzione

Q2  
Series



Angle head models  
Modèles d'angle  
Modelle mit Winkelkopf  
Modelos con cabeza angular  
Modelli con testa ad angolo



QA2759D with optional hanger

Ref.	1 min. rpm	Max. Nm	kg	mm	Max. mm	mm	mm	l/min	
<b>C LEVER START — DÉM. PAR LEVIER — HEBELSTART — ARRANQUE POR PALANCA — AVVIAMENTO A LEVA</b>									
	QA0539D	500	12.8	0.62	221	4.8	27	9.5	450
	QA1239D	1270	4.5	0.62	221	4.8	27	9.5	450
	QA2739D	2700	2.3	0.62	221	4.8	27	9.5	450
	QA0559D	500	12.8	0.62	221	—	27	9.5	450
	QA0859D	850	7.6	0.62	221	—	27	9.5	450
	QA2759D	2700	2.3	0.62	221	—	27	9.5	450

Collets for Q2 angle drills  
Pincas pour perceuses Q2  
Spannzangen für Q2 Winkelbohrmaschinen  
Pinzas para taladros angulares Q2  
Pinze per trapani ad angolo Q2



Ø mm	Ref. No.	Ø mm	Ref. No.	Ø mm	Ref. No.	Ø mm	Ref. No.	Ø mm	Ref. No.	Ø mm	Ref. No.
1.0	43497-60	1.7	43497-51	2.5	43497-38	3.5	43497-28	4.5	43497-15	5/64	43497-162
1.05	43497-58	1.8	43497-50	2.6	43497-37	3.6	43497-27	4.6	43497-14	3/32	43497-163
1.1	43497-57	1.9	43497-48	2.7	43497-35	3.7	43497-25	4.7	43497-13	7/64	43497-164
1.2	43497-56	2.0	43497-45	2.8	43497-33	3.8	43497-24	4.8	43497-11	1/8	43497-165
1.3	43497-55	2.1	43497-44	2.9	43497-32	3.9	43497-23	4.9	43497-9	9/64	43497-166
1.4	43497-54	2.2	43497-43	3.0	43497-31	4.0	43497-20	5.0	43497-8	5/32	43497-167
1.5	43497-53	2.3	43497-42	3.2	43497-30	4.3	43497-18	5.1	43497-7	11/64	43497-168
1.6	43497-52	2.4	43497-40	3.4	43497-29	4.4	43497-16	1/16	43497-161	3/16	43497-169

Series / Baureihe				
Q2	0.21 kW	75 dBa	1/4" NPT	6 mm



# 5 to 7 Series

**Production Drills**  
**Perceuses de production**  
**Bohrmaschinen für Industrieinsatz**  
**Taladros para producción**  
**Trapani per produzione**

**Standard Equipment**

Variable speed control

Drill chuck and key

Skinsulate™ Soft touch, non-slip grip on pistol models

Dead handle on models 5LN3-EU and 7AQST8-EU

Contrôle de la vitesse

Mandrin et clé de mandrin

Revêtement anti-dérapant Skinsulate™ sur modèles à poignée révolver

Poignée auxiliaire sur modèles 5LN3-EU et 7AQST8-EU

Variable Geschwindigkeitskontrolle

Bohrfutter und Schlüssel

Skinsulate™ Weicher, rutschfester Griff (Modelle mit Pistolengriff)

Hilfsgriff (für Modelle 5LN3-EU und 7AQST8-EU)

Gatillo de velocidad variable

Portabrocas y llave

Empuñadura suave, antideslizante Skinsulate™ (modelos de pistola)

Mango de sujeción para 5LN3-EU y 7AQST8-EU

Grilletto a velocità variabile

Mandrino e chiave

Impugnatura morbida, antiscivolo Skinsulate™ (modelli con impugnatura a pistola)

Impugnatura ausiliaria per 5LN3-EU e 7AQST8-EU

**Skinsulate™**  
Comfort Coating



5RANST8-EU



5AJST4-EU



7AQST8-EU

Specifications at 90 psi – Caractéristiques à 620 kPa – Technische Daten bezogen auf 620 kPa  
 Especificaciones a 620 kPa – Caratteristiche a 620 kPa

**Pistol grip models**  
**Modèles à poignée révolver**  
**Modelle mit Pistolengriff**  
**Modelos con empuñadura de pistola**  
**Modelli con impugnatura a pistola**

Ref.	1 min. rpm	Max Nm	 kg	 mm	 Max. mm	 in	 mm	 l/min
<b>DC TRIGGER START — DÉM. PAR GÂCHETTE — DRÜCKERSTART — ARRANQUE POR GATILLO — AVVIAMENTO A GRILLETTO</b>								
5RANST8-EU	900	8.00	1.40	210	13	3/8-24	21	480
5RALST6-EU	2000	4.00	1.00	157	10	3/8-24	21	480
<b>C TRIGGER START — DÉM. PAR GÂCHETTE — DRÜCKERSTART — ARRANQUE POR GATILLO — AVVIAMENTO A GRILLETTO</b>								
7AQST8-EU	600	30.5	1.47	222	13	3/8-24	22	700
7ANST8-EU	900	20.9	1.45	222	13	3/8-24	22	700
5ANST6-EU	1000	9.00	1.25	207	10	3/8-24	21	480
7AMST6-EU	1400	14.7	1.33	216	10	3/8-24	22	700
5ALST4-EU	2200	4.50	0.90	173	6	3/8-24	21	480
7ALST6-EU	2400	8.81	1.22	189	10	3/8-24	22	700
5AKST4-EU	3000	3.40	0.90	173	6	3/8-24	21	480
7AKST6-EU	3200	6.55	1.08	194	10	3/8-24	22	700
5AJST4-EU	4500	2.30	0.90	173	6	3/8-24	21	480
7AJST4-EU	4800	4.52	1.05	189	6	3/8-24	22	700
7AHST4-EU	6000	3.73	1.05	189	6	3/8-24	22	700
7ADST4-EU	20000	1.13	1.02	189	6	3/8-24	22	700

Production Drills  
Perceuses de production  
Bohrmaschinen für Industrieinsatz  
Taladros para producción  
Trapani per produzione

5 to 7  
Series



Straight handle models  
Modèles à poignée droite  
Modelle in gerader Ausführung  
Modelos con empuñadura recta  
Modelli con impugnatura diritta



Ref.	1 min. rpm	Max. Nm	kg	mm	Max. mm	in	mm	l/min
<b>C LEVER START — DÉM. PAR LEVIER — HEBELSTART — ARRANQUE POR PALANCA — AVVIAMENTO A LEVA</b>								
5LN3-EU	1050	9.00	1.50	238	10	3/8-24	21	480
5LL1-EU	2300	4.50	0.90	205	6	3/8-24	21	480
5LK1-EU	3100	3.40	0.90	205	6	3/8-24	21	480
5LJ1-EU	4800	2.30	0.90	205	6	3/8-24	21	480

Angle head models  
Modèles d'angle  
Modelle mit Winkelkopf  
Modelos con cabeza angular  
Modelli con testa ad angolo



Ref.	1 min. rpm	Max. Nm	kg	mm	Max. mm	mm	mm	l/min
<b>C LEVER START — DÉM. PAR LEVIER — HEBELSTART — ARRANQUE POR PALANCA — AVVIAMENTO A LEVA</b>								
	5LL1A4-EU	2200	4.5	1.00	249	4.8	30	9.0
	5LK1A4-EU	3000	3.5	1.00	249	4.8	30	9.0
	7LN3A44-EU	600	31.1	1.90	281	13	105	18
	5LN2A43-EU	700	13.6	1.60	259	10	91	14
	7LM3A43-EU	900	21.7	1.79	281	10	99	18
	5LL2A41-EU	1500	6.8	1.20	239	6	75	14

Collets for models 5LL1A4-EU and 5LK1A4-EU  
Pincos pour perceuses 5LL1A4-EU et 5LK1A4-EU  
Spannzangen für 5LL1A4-EU und 5LK1A4-EU Modelle  
Pinzas para taladros angulares 5LL1A4-EU y 5LK1A4-EU  
Pinze per trapani ad angolo 5LL1A4-EU e 5LK1A4-EU

Ø mm	Ref. No.	Ø mm	Ref. No.
2.0	43497-45	5/64	43497-162
2.5	43497-38	3/32	43497-163
3.0	43497-31	7/64	43497-164
3.5	43497-28	1/8	43497-165
4.0	43497-20	9/64	43497-166
4.5	43497-15	5/32	43497-167
5.0	43497-8	11/64	43497-168
1/16	43497-161	3/16	43497-169

Series / Baureihe				
5	0.30 kW	75 dBa	1/4" NPT	6 mm
7	0.57 kW	80 dBa	1/4" NPT	8 mm

# Precision Drills Selection Chart

## Table de sélection perceuses de précision

## Präzisions-Bohrmaschinen-Auswahltabelle

## Cuadro de selección de taladros de precisión

## Tabella di selezione delle trapani di precisione



Precision Drills  
Perceuses de précision  
Präzisions-Bohrmaschinen  
Taladros de precisión  
Trapani di precisione



Pistol grip models • Modèles à poignée révolver • Modelle mit Pistolengriff • Modelos con empuñadura de pistola • Modelli con impugnatura a pistola



Model No.	RPM	2 Nm	4 Nm	6 Nm	8 Nm	10 Nm	12 Nm	14 Nm	16 Nm	Page
P33054-PSL	5400	█								41
P33032-PSL	3200	█	█							41
P33022-PSL	2200	█	█	█						41
P33016-PSL	1600	█	█	█	█					41
P33011-PSL	1100	█	█	█	█	█				41
P33006-PSL	660	█	█	█	█	█	█	█	█	41

Straight handle models • Modèles à poignée droite • Modelle in gerader Ausführung • Modelos con empuñadura recta • Modelli con impugnatura diritta



Model No.	RPM	2 Nm	4 Nm	6 Nm	8 Nm	10 Nm	12 Nm	14 Nm	16 Nm	Page
P33180-DSL	18000	█								41
P33110-DSL	11000	█	█							41
P33054-DSL	5400	█								41
P33032-DSL	3200	█	█							41
P33022-DSL	2200	█	█	█						41
P33016-DSL	1600	█	█	█	█					41
P33011-DSL	1100	█	█	█	█	█				41
P33006-DSL	660	█	█	█	█	█	█	█	█	41

Modular Drills • PerceusesModulaires • Modulare Bohrmaschinen • Taladros Modulares • Trapani Modulari

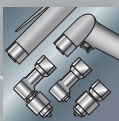

Model No.	RPM	2 Nm	4 Nm	6 Nm	8 Nm	10 Nm	12 Nm	14 Nm	16 Nm	Page
P33054-PMSL	5400	█								42
P33032-PMSL	3200	█	█							42
P33022-PMSL	2200	█	█	█						42
P33016-PMSL	1600	█	█	█	█					42
P33011-PMSL	1100	█	█	█	█	█				42
P33006-PMSL	660	█	█	█	█	█	█	█	█	42
P33054-DMSL	5400	█								42
P33032-DMSL	3200	█	█							42
P33022-DMSL	2200	█	█	█						42
P33016-DMSL	1600	█	█	█	█					42
P33011-DMSL	1100	█	█	█	█	█				42
P33006-DMSL	660	█	█	█	█	█	█	█	█	42

Angle head models • Modèles d'angle • Modelle mit Winkelkopf • Modelos con cabeza angular • Modelli con testa ad angolo

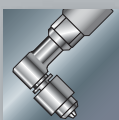

Model No.	RPM	2 Nm	4 Nm	6 Nm	8 Nm	10 Nm	12 Nm	14 Nm	16 Nm	Page
P33054-DASL...	5400	█								44
P33032-DASL...	3200	█	█							44
P33022-DASL...	2200	█	█	█						44
P33016-DASL...	1600	█	█	█	█					44
P33011-DASL...	1100	█	█	█	█	█				44
P33006-DASL...	660	█	█	█	█	█	█	█	█	44



Precision Drills  
Perceuses de précision  
Präzisions-Bohrmaschinen  
Taladros de precisión  
Trapani di precisione

P33  
Series



Standard  
Equipment

Variable speed control	Contrôle de la vitesse	Variable Geschwindigkeitskontrolle	Gatillo de velocidad variable	Grilletto a velocità variabile
Drill chuck and key	Mandrin et clé de mandrin	Bohrfutter und Schlüssel	Portabrocas y llave	Mandrino e chiave
Lube free motor	Moteur non lubrifié	Ölfreier Motor	Motor sin lubricación	Motore senza lubrificazione
Chuck guard	Cache mandrin	Bohrfutterschutz	Protector de portabrocas	Protezione mandrino

Specifications at 90 psi – Caractéristiques à 620 kPa – Technische Daten bezogen auf 620 kPa  
Especificaciones a 620 kPa – Caratteristiche a 620 kPa



Pistol grip models  
Modèles à poignée révolver  
Modelle mit Pistolengriff  
Modelos con empuñadura de pistola  
Modelli con impugnatura a pistola

Skinsulate™  
Comfort Coating



P33054-PSL

Ref.	1 min. rpm	Max. Nm	kg	mm	Max. mm	in	mm	l/min
<b>C TRIGGER START — DÉM. PAR GÂCHETTE — DRÜCKERSTART — ARRANQUE POR GATILLO — AVVIAMENTO A GRILLETTO</b>								
P33006-PSL	660	16.0	1.15	209	10	3/8-24	22	600
P33011-PSL	1100	9.5	1.15	209	10	3/8-24	22	600
P33016-PSL	1600	6.8	1.15	209	8	3/8-24	22	600
P33022-PSL	2200	4.5	1.05	194	8	3/8-24	22	600
P33032-PSL	3200	3.2	1.05	194	8	3/8-24	22	600
P33054-PSL	5400	1.9	1.05	194	6	3/8-24	22	600

Straight handle models  
Modèles à poignée droite  
Modelle in gerader Ausführung  
Modelos con empuñadura recta  
Modelli con impugnatura diritta



P33054-DSL

Ref.	1 min. rpm	Max. Nm	kg	mm	Max. mm	in	mm	l/min
<b>C LEVER START — DÉM. PAR LEVIER — HEBELSTART — ARRANQUE POR PALANCA — AVVIAMENTO A LEVA</b>								
P33006-DSL	660	16.0	1.0	235	10	3/8-24	22	600
P33011-DSL	1100	9.50	1.0	235	10	3/8-24	22	600
P33016-DSL	1600	6.80	0.94	227	8	3/8-24	22	600
P33022-DSL	2200	4.50	0.90	212	8	3/8-24	22	600
P33032-DSL	3200	3.20	0.90	212	8	3/8-24	22	600
P33054-DSL	5400	1.90	0.90	212	6	3/8-24	22	600
P33110-DSL	11000	0.90	0.96	227	6	3/8-24	22	600
P33180-DSL	18000	0.55	0.90	212	6	3/8-24	22	600

Series / Baureihe				
P33	0.33 kW	76 dBa	1/4" BSP	9 mm



**P33  
Series**

**Precision Drills**  
**Perceuses de précision**  
**Präzisions-Bohrmaschinen**  
**Taladros de precisión**  
**Trapani di precisione**

**Standard  
Equipment**

Lube free motor

Moteur non lubrifié

Ölfreier Motor

Motor sin lubricación

Motore senza lubrificazione

Variable speed control

Contrôle de la vitesse

Variable Geschwindigkeitskontrolle

Gatillo de velocidad variable

Grilletto a velocità variabile

Drill chuck and key (on models delivered with chuck)

Mandrin et clé (sur modèles livrés avec mandrin en standard)

Bohrfutter und Schlüssel (Modelle mit Bohrfutter)

Portabrocas y llave (sólo modelos con portabrocas)

Mandrino e chiavetta (modelli con Mandrino)

Specifications at 90 psi – Caractéristiques à 620 kPa – Technische Daten bezogen auf 620 kPa  
 Especificaciones a 620 kPa – Caratteristiche a 620 kPa



P33016-PMSL



R33M090D17P64



P33022-DMSL

**Motor modules**  
**Modules moteurs**  
**Motor-Module**  
**Módulos de motor**  
**Motori modulari**

Ref.	1 min. rpm	Max. Nm	 kg	A mm	 mm	 l/min
<b>C PISTOL GRIP / TRIGGER START — POIGNÉE RÉVOLVER / DÉM. PAR GACHETTE — PISTOLENGRIFF / DRÜCKERSTART EMPUÑADURA DE PISTOLA / MANDO POR GATILLO — IMPUGNATURA A PISTOLA / AVVIAMENTO A GRILLETTO</b>						
P33006-PMSL	660	16	0.92	161	21.3	600
P33011-PMSL	1100	9.5	0.92	161	21.3	600
P33016-PMSL	1600	6.8	0.92	161	21.3	600
P33022-PMSL	2200	4.5	0.81	146	21.3	600
P33032-PMSL	3200	3.2	0.80	146	21.3	600
P33054-PMSL	5400	1.9	0.80	146	21.3	600
<b>C STRAIGHT GRIP / BUTTON CONTROL — POIGNÉE DROITE / DÉM. PAR BOUTON POUSSOIR — GERADE AUSFÜHRUNG / VENTILKNOPF EMPUÑADURA RECTA / MANDO POR BOTÓN — IMPUGNATURA DIRITTA / AVVIAMENTO A PULSANTE</b>						
P33032-DMSL-B	3200	3.2	0.64	164	22	600
P33054-DMSL-B	5400	1.9	0.63	164	22	600
<b>C STRAIGHT GRIP / LEVER CONTROL — POIGNÉE DROITE / DÉM. PAR LEVIER — GERADE AUSFÜHRUNG / HEBELSTART EMPUÑADURA RECTA / MANDO POR PALANCA — IMPUGNATURA DIRITTA / AVVIAMENTO A LEVA</b>						
P33006-DMSL	660	16	0.79	179	22	600
P33011-DMSL	1100	9.5	0.79	179	22	600
P33016-DMSL	1600	6.8	0.79	179	22	600
P33022-DMSL	2200	4.5	0.68	164	22	600
P33032-DMSL	3200	3.2	0.67	164	22	600
P33054-DMSL	5400	1.9	0.67	164	22	600

Series / Baureihe				
P33	0.33 kW	76 dBa	1/4" BSP	9 mm



See drill collets pages 45.  
 Pinces présentées page 45.  
 Spannzangen für Bohrmaschinen, siehe Seite 45.  
 Pinzas para taladros angulares presentadas en página 45.  
 Per le pinze per trapani, vedere pagina 45.





Modular Drill Attachments  
Têtes de perçage modulaires  
Modulare Bohraufsätze  
Cabeza de taladro modulares  
Attachi per trapani modulari

660 RPM  
1100 RPM  
1600 RPM  
2200 RPM  
3200 RPM  
5400 RPM

660 RPM  
1100 RPM  
1600 RPM  
2200 RPM  
3200 RPM  
5400 RPM

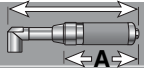
Collets for R33 heads on page 45.  
Pinces pour têtes R33 présentées page 45.  
Spannzangen für R33 Winkelköpfe, siehe S. 45.  
Pinzas para cabezas de taladro R33, ver página 45.  
Pinze per teste di foratura R33, vedere pag. 45.

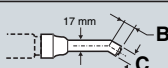
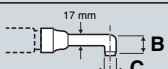
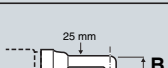
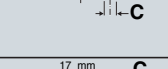
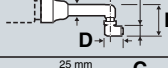
	Ref.	Max. mm	 mm	B mm	C mm	D mm	 kg
	1 R33M000F1/4	8.0	A + 40	-	-	-	0.16
	2 R33M000F5/16	8.0	A + 40	-	-	-	0.16
	3 R33M000P64	6.4	A + 42	-	-	-	0.16
	4 R33M000M80	8.0	A + 81	-	-	-	0.38
	5 R33M030D17F1/4	6.4	A+118	24.0	18	-	0.24
	6 R33M030D17P45	4.5	A + 112	19.5	18	-	0.24
	7 R33M030D17P64	6.4	A+124	31.5	18	-	0.26
	8 R33M090D17F1/4	6.4	A+105	36.0	18	-	0.24
	9 R33M090D17P45	4.5	A+105	36.0	18	-	0.24
	10 R33M090D17P64	6.4	A+105	43.5	18	-	0.26
	11 R33M090D25F1/4	8.0	A + 78	44.0	25	-	0.34
	12 R33M090D25F5/16	8.0	A + 78	44.0	25	-	0.34
	13 R33M090D25F80	8.0	A + 78	50.0	25	-	0.36
	14 R33M090D25M80	8.0	A + 81	98.5	30	-	0.54
	15 R33M090D25P80	8.0	A + 78	54.0	25	-	0.39
	16 R33M180D17F1/4	6.4	A+124	64.0	18	36	0.30
	17 R33M180D17P45	4.5	A+120	64.0	18	32	0.30
	18 R33M180D17P64	6.4	A+131	64.0	18	44	0.32
	19 R33M180D25F1/4	8.0	A + 99	87.5	25	44	0.40
	20 R33M180D25F5/16	8.0	A + 99	87.5	25	44	0.40
	21 R33M180D25P80	8.0	A+109	87.5	25	54	0.45



**P33  
Series**

**Precision Drills**  
**Perceuses de précision**  
**Präzisions-Bohrmaschinen**  
**Taladros de precisión**  
**Trapani di precisione**

**Standard  
Equipment**

**Lube free motor**

**Variable speed control**

Moteur non lubrifié  
 Contrôle de la vitesse

Ölfreier Motor  
 Variable Geschwindigkeit-kontrolle

Motor sin lubricación  
 Gatillo de velocidad variable





Motore senza lubrificazione  
 Grilletto a velocità variabile

Specifications at 90 psi – Caractéristiques à 620 kPa – Technische Daten bezogen auf 620 kPa  
 Especificaciones a 620 kPa – Caratteristiche a 620 kPa



P33022-DASL090P45

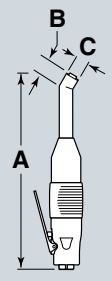
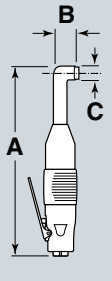
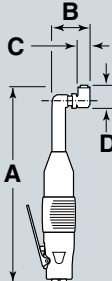

Ref.	 rpm	 Nm	 kg	 mm	<b>A</b> mm	<b>B</b> mm	<b>C</b> mm	<b>D</b> mm	 l/min	
<b>C WITH 30° ANGLE HEAD — AVEC TÊTE D'ANGLE À 30° — MIT 30° WINKELKOPF — CON CABEZA ANGULAR 30° — CON TESTA AD ANGOLO 30°</b>										
	P33006-DASL030P45	660	16	0.88	1.0-4.5	284	19.5	17	—	600
	P33006-DASL030P64	660	16	0.88	1.6-6.4	296	31.5	17	—	600
	P33011-DASL030P45	1100	9.5	0.88	1.0-4.5	284	19.5	17	—	600
	P33011-DASL030P64	1100	9.5	0.88	1.6-6.4	296	31.5	17	—	600
	P33016-DASL030P45	1600	6.8	0.88	1.0-4.5	284	19.5	17	—	600
	P33016-DASL030P64	1600	6.8	0.88	1.6-6.4	296	31.5	17	—	600
	P33022-DASL030P45	2200	4.5	0.77	1.0-4.5	269	19.5	17	—	600
	P33022-DASL030P64	2200	4.5	0.77	1.6-6.4	281	31.5	17	—	600
	P33032-DASL030P45	3200	3.2	0.76	1.0-4.5	269	19.5	17	—	600
	P33032-DASL030P64	3200	3.2	0.76	1.6-6.4	281	31.5	17	—	600
P33054-DASL030P45	5400	1.9	0.76	1.0-4.5	269	19.5	17	—	600	
P33054-DASL030P64	5400	1.9	0.76	1.6-6.4	281	31.5	17	—	600	
<b>C WITH 90° ANGLE HEAD — AVEC TÊTE D'ANGLE À 90° — MIT 90° WINKELKOPF — CON CABEZA ANGULAR 90° — CON TESTA AD ANGOLO 90°</b>										
	P33006-DASL090P45	660	16	0.88	1.0-4.5	277	31	17	—	600
	P33006-DASL090P64	660	16	0.89	1.6-6.4	277	43	17	—	600
	P33011-DASL090P45	1100	9.5	0.88	1.0-4.5	277	31	17	—	600
	P33011-DASL090P64	1100	9.5	0.89	1.6-6.4	277	43	17	—	600
	P33016-DASL090P45	1600	6.8	0.88	1.0-4.5	277	31	17	—	600
	P33016-DASL090P64	1600	6.8	0.89	1.6-6.4	277	43	17	—	600
	P33022-DASL090P45	2200	4.5	0.77	1.0-4.5	262	31	17	—	600
	P33022-DASL090P64	2200	4.5	0.78	1.6-6.4	262	43	17	—	600
	P33032-DASL090P45	3200	3.2	0.77	1.0-4.5	262	31	17	—	600
	P33032-DASL090P64	3200	3.2	0.78	1.6-6.4	262	43	17	—	600
P33054-DASL090P45	5400	1.9	0.76	1.0-4.5	262	31	17	—	600	
P33054-DASL090P64	5400	1.9	0.77	1.6-6.4	262	43	17	—	600	
<b>C WITH 180° ANGLE HEAD — AVEC TÊTE D'ANGLE À 180° — MIT 180° WINKELKOPF — CON CABEZA ANGULAR 180° — CON TESTA AD ANGOLO 180°</b>										
	P33006-DASL180P45	660	16	0.94	1.0-4.5	292	63.2	17	31	600
	P33006-DASL180P64	660	16	0.96	1.6-6.4	304	63.2	17	43	600
	P33011-DASL180P45	1100	9.5	0.94	1.0-4.5	292	63.2	17	31	600
	P33011-DASL180P64	1100	9.5	0.96	1.6-6.4	304	63.2	17	43	600
	P33016-DASL180P45	1600	6.8	0.94	1.0-4.5	292	63.2	17	31	600
	P33016-DASL180P64	1600	6.8	0.96	1.6-6.4	304	63.2	17	43	600
	P33022-DASL180P45	2200	4.5	0.83	1.0-4.5	277	63.2	17	31	600
	P33022-DASL180P64	2200	4.5	0.85	1.6-6.4	289	63.2	17	43	600
	P33032-DASL180P45	3200	3.2	0.82	1.0-4.5	277	63.2	17	31	600
	P33032-DASL180P64	3200	3.2	0.84	1.6-6.4	289	63.2	17	43	600
P33054-DASL180P45	5400	1.9	0.82	1.0-4.5	277	63.2	17	31	600	
P33054-DASL180P64	5400	1.9	0.84	1.6-6.4	289	63.2	17	43	600	



Collets for P33 angle drills and R33 heads  
Pinces pour perceuses d'angle P33 et têtes R33  
Spannzangen für P33 Bohrmaschinen und R33 Winkelköpfe  
Pinzas para taladros angulares P33 y cabezas de taladro R33  
Pinze per trapani ad angolo P33 e teste di foratura R33



Threaded collets for .....P45 heads  
Pince fileté pour têtes .....P45  
Gewinde-Spannz. für .....P45 köpfe  
Pinza roscada para cabezas .....P45  
Pinza filettata per teste .....P45

Ø mm	Ref. No.
1.0	120071
1.5	120072
2.0	120073
2.2	120102
2.4	120106
2.5	120074
3.0	120075
3.1	120105
3.2	120109
3.25	120104
3.3	120113
3.5	120076
3.6	123991
3.7	121552
3.8	125783
3.9	120107
4.0	120077
4.1	120103
4.2	120110
4.5	120078
4.6	120111
4.7	125784
4.8	120112
4.9	121553
5.0	120079



Plain collets for .....P64 heads  
Pince conique pour têtes .....P64  
Spannz. ohne Gewinde für .....P64 köpfe  
Pinza sencilla para cabezas .....P64  
Pinza non filettata per teste .....P64

Ø mm	Ref. No.
1.6	128250
1.8	128251
2.0	128252
2.2	128253
2.4	128254
2.6	128255
2.8	128256
3.0	128257
3.2	128258
3.4	128259
3.6	128260
3.8	128261
4.0	128262
4.2	128263
4.4	128264
4.6	128265
4.8	128266
5.0	128267
5.2	128268
5.4	128269
5.6	128270
5.8	128271
6.0	128272
6.2	128273
6.4	128274



Plain collets for .....P80 heads  
Pince conique pour têtes .....P80  
Spannz. ohne Gewinde für .....P80 köpfe  
Pinza sencilla para cabezas .....P80  
Pinza non filettata per teste .....P80

Ø mm	Ref. No.
2.4	128280
2.6	128281
2.8	128282
3.0	128283
3.2	128284
3.4	128285
3.6	128286
3.8	128287
4.0	128288
4.2	128289
4.4	128290
4.6	128291
4.8	128292
5.0	128293
5.2	128294
5.4	128295
5.6	128296
5.8	128297
6.0	128298
6.2	128299
6.4	128300
6.6	128301
6.8	128302
7.0	128303
7.2	128304
7.4	128305
7.6	128306
7.8	128307
8.0	128308



Threaded collets for .....F80 heads  
Pince fileté pour têtes .....F80  
Gewinde-Spannz. für .....F80 köpfe  
Pinza roscada para cabezas .....F80  
Pinza filettata per teste .....F80

Ø mm	Ref. No.
2.0	128310
2.5	128311
3.0	128312
3.5	128313
4.0	128314
4.5	128315
5.0	128316
5.5	128317
6.0	128318
6.5	128319
7.0	128320
7.5	128321
8.0	128322

6

Series / Baureihe				
P33	0.33 kW	76 dBa	1/4" BSP	9 mm

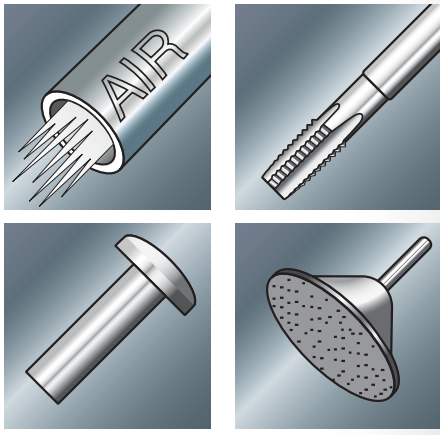

## Other Air Tools

*Autres Outils Pneumatiques  
Sonstige Druckluftwerkzeuge  
Otras Herramientas Neumaticas  
Altri Utensili Pneumatici*

47

**Q2/MS  
7 Series**

Air Tappers and Multi-Function Drill  
Taraudeuses et perceuse multi-fonctions  
Gewindeschneidmaschinen und Multi-Funktions-  
Bohrmaschine  
Roscadoras neumáticas y taladro multi-funcional  
Filettatrici pneumatiche e trapano multi-funzioni

48

**AVC  
Series**

Air Riveters  
Riveurs pneumatiques légers  
Druckluft-Niethämmer  
Remachadores neumáticos  
Martelli ribaditori pneumatici

49

**PBA  
Series**

Air Sanders  
Polisseuses pneumatiques  
Druckluft-Schmirgelmaschinen  
Lijadoras neumáticas  
Levigatrici pneumatiche



**Air Tappers**  
**Taraudeuses pneumatiques**  
**Druckluft-Gewindeschneidmaschinen**  
**Roscadoras neumáticas**  
**Filettatrici pneumatiche**

**Q2 &  
7 Series**



**Standard  
Equipment**

Dead handle assembly on 7 Series	Poignée auxiliaire sur série 7	Hilfsgriff (für Baureihe 7)	Mango de sujeción para serie 7	Impugnatura ausiliaria per serie 7
----------------------------------	--------------------------------	-----------------------------	--------------------------------	------------------------------------

Specifications at 90 psi – Caractéristiques à 620 kPa – Technische Daten bezogen auf 620 kPa – Especificaciones a 620 kPa – Caratteristiche a 620 kPa

Series / Baureihe				
Q2	0.24 kW	75 dBa	1/4" NPT	6 mm
7	0.44 kW	79 dBa	1/4" NPT	8 mm

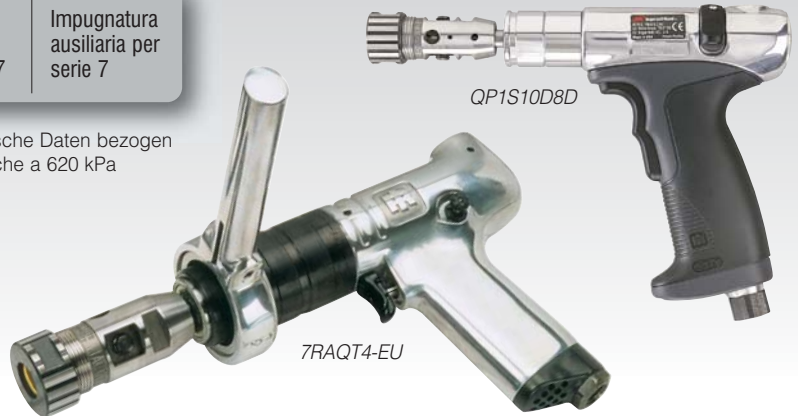

Ref.	1 min. rpm	Max. Nm	kg	mm	Max. mm	in	mm	l/min
<b>DC TRIGGER START — DÉM. PAR GÂCHETTE — DRÜCKERSTART — ARRANQUE POR GATILLO — AVVIAMENTO A GRILLETTO</b>								
QP1S10D8D	1000	5.2	0.85	183	6	Conical (CM1)	15	450
QP1S05D8D	500	9.8	0.85	183	6	Conical (CM1)	15	450
7RAQT4-EU	475	27	1.50	300	13	Conical (CM1)	22	760

**Air Multi-Function Drill**  
**Perceuse multi-fonction pneumatique**  
**Druckluft-Multi-Funktions-Bohrmaschine**  
**Taladro neumático multi-funcional**  
**Trapano pneumatico multi-funzioni**

**MS  
Series**



**Standard  
Equipment**

Direct drive	Entraînement direct	Direktantrieb	Accionamiento directo	Trasmissione diretta
Horizontal hanger	Suspension horizontale	Horizontal-Aufhänger	Suspensión horizontal	Sospensione orizzontale

Specifications at 90 psi – Caractéristiques à 620 kPa – Technische Daten bezogen auf 620 kPa – Especificaciones a 620 kPa – Caratteristiche a 620 kPa

Series / Baureihe				
MS	0.33 kW	78 dBa	1/4" BSP	9 mm



Ref.	1 min. rpm	Max. Nm	kg	mm	Max. mm	in	mm	l/min
<b>DC TRIGGER START — DÉM. PAR GÂCHETTE — DRÜCKERSTART — ARRANQUE POR GATILLO — AVVIAMENTO A GRILLETTO</b>								
MS2206RP5-Q4	600	11	1.00	190	8	1/4" Ⓞ	20	570

**Options**



Ø 0-8 mm:  
Ref. **123182**  
Ø 1-10 mm:  
Ref. **123205**



Ø 0-6 mm:  
Ref. **123203**  
Ø 1-10 mm:  
Ref. **123204**



**AVC  
Series**

**Air Riveters**  
**Riveurs pneumatiques légers**  
**Druckluft-Niethämmer**  
**Remachadores neumáticos**  
**Martelli ribaditori pneumatici**

**Standard  
Equipment**

Beehive type rivet set retainer

Tease throttle on models AVC10A1-EU, AVC12A1-EU and AVC13A1-EU

Ressort de retenue fermé

Soupape de mise en route à action progressive sur modèles AVC10A1-EU, AVC12A1-EU, AVC13A1-EU

Sicherheits-Haltesfeder

Feinfühliges, stufenlos regelbares Drosselventil für die Mod. AVC10A1-EU, AVC12A1-EU und AVC13A1-EU

Retenedor tipo colmena

Válvula accionamiento progresivo para modelos AVC10A1-EU, AVC12A1-EU y AVC13A1-EU

Molla di ritenuta chiusa

Valvola immissione graduale per modelli AVC10A1-EU, AVC12A1-EU e AVC13A1-EU



Specifications at 90 psi – Caractéristiques à 620 kPa – Technische Daten bezogen auf 620 kPa  
 Especificaciones a 620 kPa – Caratteristiche a 620 kPa

Ref.	Aluminium		Dural & soft iron		mm	kg	mm	Ø mm	1 min.	Ø mm	l/min
	Ø mm	Ø mm	Ø mm	Ø mm							
<b>TRIGGER START — DÉM. PAR GÂCHETTE — DRÜCKERSTART — ARRANQUE POR GATILLO — AVVIAMENTO A GRILLETTO</b>											
AVC10A1-EU	3	3	143	1.2	48	14	3200	10	360		
AVC10C1-EU	3	3	172	0.95	48	14	3200	10	360		
AVC12A1-EU	5	5	191	1.4	76	14	2100	10	360		
AVC13A1-EU	6	6	216	1.5	101	14	1725	10	360		
AVC26A1-EU	10	8	276	2.3	152	19	1120	12.7	420		
AVC26B1-EU	10	8	359	3.1	152	14	1120	12.7	420		

Series / Baureihe			
AVC	94 → 97 dBa	1/4" NPT	8 mm

**Accessories**  
**Accessoires**  
**Zubehör**  
**Accesorios**  
**Accessori**

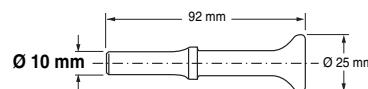

Ref. No. AV1-126D

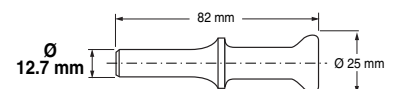

Ref. No. AV24-126D

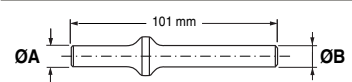
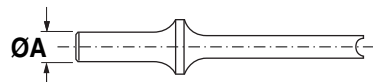

ØA mm	Ø mm	(Button head)	(Round head)	(Brazier head)	(Mushroom head)	(Flat head)	(Universal head)
10	1	–	AV1-22B-2	–	–	–	–
10	2	–	–	–	–	–	AV1-22H-3
10	3	AV1-22A-4	AV1-22B-4	AV1-22C-4	–	–	–
10	4	–	–	AV1-22C-5	–	–	AV1-22H-5
10	5	AV1-22A-6	AV1-22B-6	AV1-22C-6	–	AV1-22G-8	AV1-22H-6
10	6	AV1-22A-8	AV1-22B-8	AV1-22C-8	AV1-22F-8	AV1-22G-8	AV1-22H-8
10	8	AV1-22A-10	AV1-22B-10	AV1-22C-10	–	AV1-22G-10	–
12.7	5	–	–	AV24-222C-6	–	–	AV24-222H-6
12.7	6	AV24-222A-8	AV24-222B-8	AV24-222C-8	–	AV24-222G-8	–
12.7	8	AV24-222A-10	AV14-222B-10	–	AV24-222F-10	AV24-222G-10	AV24-222H-10
12.7	9	AV24-222A-12	–	–	–	–	–

Ø A mm	Ø B mm	Ref. No.
10	13	AV1-22S-16
10	16	AV1-22S-20
10	19	AV1-22S-24
10	22	AV1-22S-28

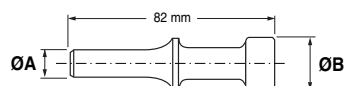

Ø A mm	Ø B mm	Ref. No.
12.7	21	AV24-222S-26
12.7	30	AV24-222S-38



**Air Sanders**  
**Polisseuses pneumatiques**  
**Druckluft-Schmirgelmachines**  
**Lijadoras neumáticas**  
**Levigatrici pneumatiche**

**PBA Series**



**Standard Equipment**

**POLA15000 delivered without pad**

POLA15000 livrée sans plateau

POLA 15000 werden ohne Schleifpads geliefert

POLA 15000 se entrega sin plato

POLA 15000 Fornita senza platorello

Specifications at 90 psi – Caractéristiques à 620 kPa – Technische Daten bezogen auf 620 kPa  
 Especificaciones a 620 kPa – Caratteristiche a 620 kPa



POLA15000



PBA416

Ref.	1 min. rpm	mm	mm	mm	kg	mm	l/min
<b>BUTTON CONTROL — DÉMARRAGE PAR BOUTON POUSSOIR — VENTILKNOPF — MANDO POR BOTÓN — AVVIAMENTO A PULSANTE</b>							
<b>PBA416</b>	14800	–	–	475 x 15	1.05	65	580
<b>POLA15000</b>	15000	20 - 30 - 46 - 76	6.35	–	0.65	90	590

Series / Baureihe				
PBA416	0.22 kW	78 dBa	1/4" BSP	13 mm
POLA15000	0.22 kW	78 dBa	1/4" BSP	13 mm

**Accessories for POLA15000**  
**Accessoires pour POLA15000**  
**Zubehör für POLA15000**  
**Accesorios para POLA15000**  
**Accessori per POLA15000**

Rubber pad for self-adhesive discs  
 Plateau caoutchouc pour disques autocollants  
 Gummi-Pads für selbstklebende Scheiben  
 Plato de goma para discos autoadhesivos  
 Platorelli in gomma per dischi autoadesivi

475 x 15 mm sanding belts (pack of 10 belts)  
 Bandes abrasives 475 x 15 mm (packs de 10)  
 Schleifbänder 475 x 15 mm (10 St. Schleifbänder)  
 Bandas abrasivas 475 x 15 mm (10 bandas)  
 Nastri abrasivi 475 x 15 mm (10 nastri)

Collet for replacement  
 Pince de remplacement  
 Spannzange  
 Pinza  
 Pinza

Ø (mm)	Ref.
20	117155
30	116920
46	116930
76	116940



Grit • Grain • Körnung Grano • Grana	Ref.
36	002300
40	002301
50	002302
60	002303
80	002304
100	002305
120	002306



Ø (mm)	Ref.
6	122629





# Air Tool Accessories

Accessoires pour Outils Pneumatiques  
Zubehör für Druckluftwerkzeuge  
Accesorios para Herramientas  
Neumáticas  
Accessori per Utensili Pneumatici

51



Airline accessories.  
Accessoires réseau d'alimentation en air.  
Zubehör für Druckluftversorgung.  
Accesorios para la red de aire.  
Accessori di linea.

52



Qualifier for Pneumatic Tools.  
Boîtier d'Assistance Qualité pour Outils  
Pneumatiques.  
Qualifikator für Druckluftwerkzeuge.  
Cualificador de Procesos para Herramientas  
Neumáticas.  
Qualificatore di Processo per Utensili  
Pneumatici.

54



Common accessories for fastening and  
drilling tools.  
Accessoires communs pour outils de vissage  
et de perçage.  
Zubehör für Schrauber und Bohrmaschinen.  
Accesorios comunes para herramientas de  
montaje y taladros.  
Accessori comuni per utensili d'assemblaggio  
e trapani.

56



Common accessories for angle wrenches.  
Accessoires communs pour clés d'angle.  
Zubehör nur für Winkelschrauber.  
Accesorios comunes para llaves angulares.  
Accessori comuni per chiavi ad angolo.

57



Common accessories for drills.  
Accessoires communs pour perceuses.  
Zubehör nur für Bohrmaschinen.  
Accesorios comunes sólo para taladros.  
Accessori comuni per trapani.

58



Accessories for QA precision fastening tools  
Accessoires visseuses de précision QA  
Zubehör für QA Exaktheit Drehschrauber  
Accesorios para llaves de precisión QA  
Accessori per avvitatori di precisione QA

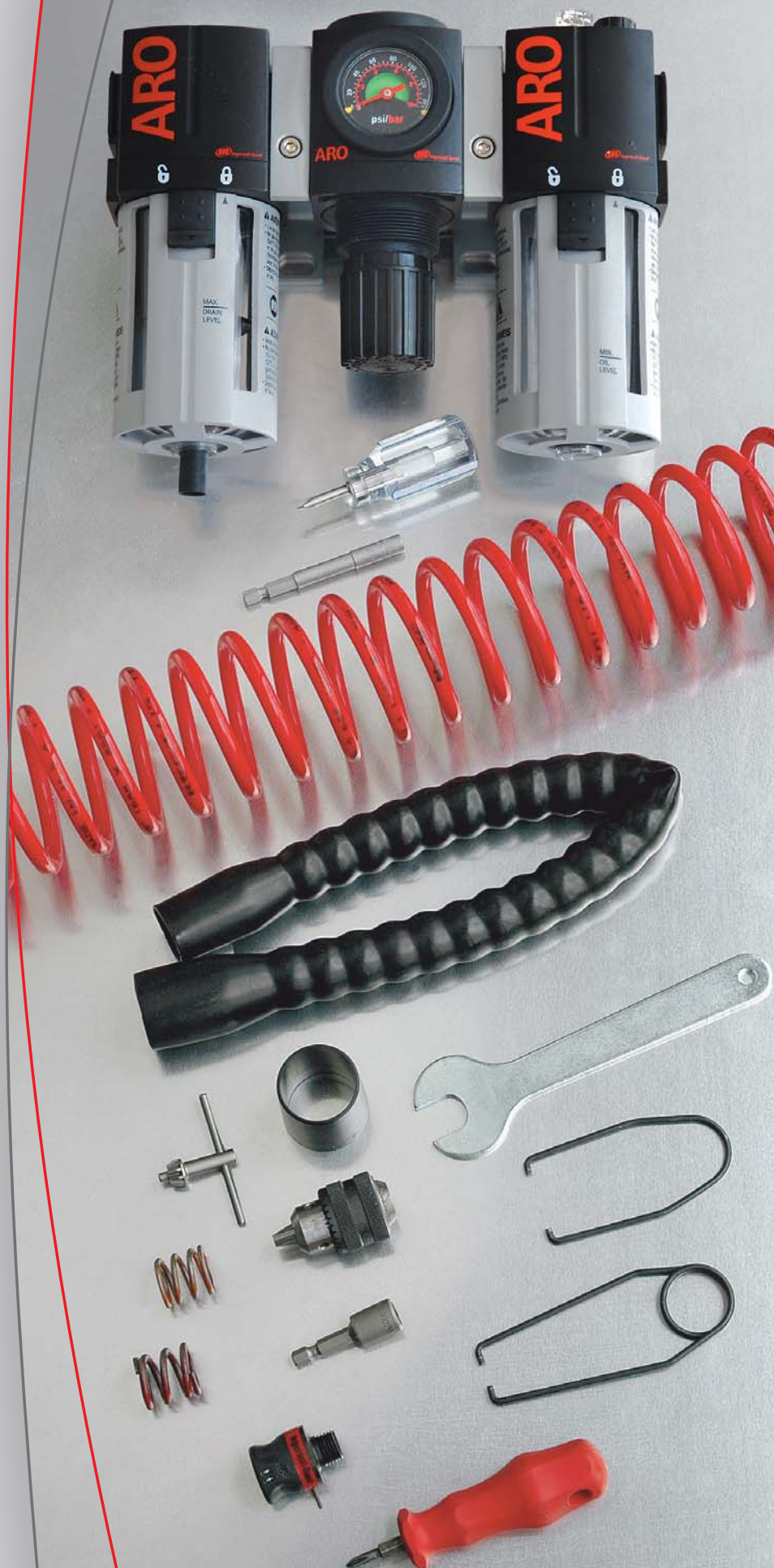

**Airline Accessories**  
**Accessoires réseau d'alimentation en air**  
**Zubehör für Druckluftversorgung**  
**Accesorios para la red de aire**  
**Accessori di linea**



**Filters - Regulators - Lubricators**

Max. inlet pressure: 17 bar (250 psi) — Filter element 5µ — Automatic drain — Metallic bowl (with sight glass on 3/8" and 1/2" models) — Gauge — Temperature range: -18°C to +79°C.

**Filtres - Régulateurs - Lubrificateurs**

Pression d'entrée maxi. 17 bar — Élément filtrant 5µ — Purge automatique — Cuve métallique (avec regard sur modèles 3/8" et 1/2") — Manomètre — Température d'utilisation: -18°C à +79°C.

**Filter-Regler-Öler**

Max. Eingangsdruck 17 bar (250 psi) — Filterelement 5µ — Automatische aftap — Metallbehälter (mit Schauglas für die 3/8"2" und 1/2" Modelle.) — Manometer — Temperaturbereich: -18°C bis +79°C.

**Filtros - Reguladores - Lubricadores**

Presión de entrada máxima: 17 bar — Elemento filtrante 5 µ — Drenaje automático — Vaso de metal (con mirilla para modelos 3/8" y 1/2").) — Manómetro — Gama de temperatura: -18°C a +79°C.

**Filtri - Regulatori - Lubrificatori**

Massima pressione di ingresso: 17 bar — Elemento filtro 5 µ — Drenaggio automatico — Coppa metallica (con spia per modelli 3/8" e 1/2").) — Manometro — Campo di temperatura: -18°C a +79°C.

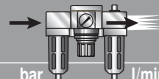
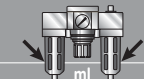

Ref.R				A	B	C
	in	bar	l/min	mm	mm	mm
<b>1 COMB. FILTER REGULATOR - FILTRE REGULATEUR - FILTER REGLER KOMBI. - FILTRO/REGULADOR COMB. - COMB. FILTRO REGOLATORE</b>						
P39124-624	1/4" NPT	0 - 10	1330	12	157	40
P39234-614	3/8" NPT	0 - 10	2550	38	229	84
P39344-614	1/2" NPT	0 - 10	4870	83	276	70
<b>2 COMBINED UNIT (FRL) - ENSEMBLE FRL - FILTER REGLER ÖLER KOMBI. - UNIDAD COMBINADA (FRL) - UNITÀ COMBINATA (FRL)</b>						
C38121-821	1/4" NPT	0 - 10	1300	21 / 21	120	148
C38231-811	3/8" NPT	0 - 10	2400	30 / 44	168	168
C38341-811	1/2" NPT	0 - 10	4250	83 / 110	221	217

**Bracket for Filter/Regulator (F.R.)**



F.R. model	Ref. bracket
P39124-624	104403
P39234-614	104404
P39344-614	104405

**Modular pipe adapter**



**Lockout valve**





**Modular clamp (for adapters and lockout valve)**



F.R. model	F.R.L. model	Adapter port size	Ref. adapter	Ref. lockout valve	Ref. modular clamp
P39124-624	C38121-821	1/8" NPT	104474-1	104390-2 (1/4" NPT port size)	104394
		1/8" BSP	104474-A		
		1/4" BSP	104474-B		
P39234-614	C38231-811	1/4" NPT	104475-2	104391-3 (3/8" NPT port size)	104395
		1/4" BSP	104475-B		
		3/8" BSP	104475-C		
P39344-614	C38341-811	3/8" NPT	104398-3	104392-4 (1/2" NPT port size)	104396
		3/8" BSP	104398-C		
		1/2" BSP	104398-D		

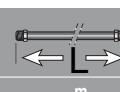
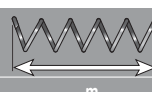

**Supercoil™ recoil hose assemblies**  
**Ensembles tuyaux spirales Supercoil™**  
**Supercoil™ Spiralschläuche**  
**Mangueras de espiral Supercoil™**  
**Tubo a spirale Supercoil™**

Ref.				
	mm	in	m	mm
IR36103	9.5	1/4 NPT	3	2.5
IR36203	9.5	1/4 NPT	6	5.0
IR36303	9.5	1/4 NPT	9	8.0
IR36102	9.5	3/8 NPT	3	2.5
IR36202	9.5	3/8 NPT	6	5.0
IR36302	9.5	3/8 NPT	9	8.0
IR37102	13	1/2 NPT	3	2.5
IR37202	13	1/2 NPT	6	5.0
IR37302	13	1/2 NPT	9	8.0

Accessory

QC  
Qualifier

Qualifier for Pneumatic Tools  
Boîtier d'assistance qualité pour outils pneumatiques  
Qualifikator für Druckluftwerkzeuge  
Cualificador de procesos para herramientas neumáticas  
Qualificatore di processo per utensili pneumatici



Standard  
Equipment

QC Qualifier	Boîtier QC Qualifier	QC-Qualifikator	Cualificador de procesos QC	Qualificatore di processo QC
Remote sensing module	Module de détection	Fernfassungsmo- dul	Modulo de detección remota	Modulo controllo remoto
Air regulator, 3/8" NPT	Régulateur d'air 3/8"	Regler - 3/8"	Regulador- 3/8"	Regolatore 3/8"
Solenoid valve, 3/8" NPT (1)	Electro-vanne, 3/8" (1)	Magnetventil - 3/8" (1)	Válvula de solenoide 3/8" (1)	Elettrovalvola - 3/8" (1)
Solenoid coil 12V DC (1)	Bobine de solenoide 12 V CC (1)	Magnetspule - 12VDC (1)	Bobina de solenoide 12 VCC (1)	Bobina elettrovalvola 12 V CC (1)
Power supplies (Europe - UK & USA)	Alimentation du boîtier (Europe, GB et USA)	Stromversorgung (Europa, GB, US)	Alimentación	Alimentatore
Operation manual	Manuel d'utilisation	Gebrauchsanweisung	Manual del usuario	Manuale d'uso

(1) On QC100SK only • Sur QC100SK uniquement • Nur für QC100SK • Sobre QC100SK solamente • Su QC100SK soltanto.

### Ref. QC100SK

For non-shut-off tools  
Pour outils sans limiteur de couple à coupure d'air  
Für Werkzeugen ohne Abschaltung  
Para herramientas sin corte de aire  
Per utensili senza arresto

### Ref. QC200SK

For shut-off tools (except QA Series)  
Pour outils avec limiteur à coupure d'air (sauf séries QA)  
Für Werkzeugen mit Abschaltung (Ausgenommen QA Serie)  
Para herramientas con corte de aire (except. serie QA)  
Per utensili con arresto (eccetto serie QA)

## Basics of operation

The QC Qualifier is designed to assist in error-proofing, batch and cycle time counting, and process flow control for the installation of threaded fasteners. The QC Qualifier is an error proofreading system and does not provide torque control or torque monitoring.

The **QC100** is designed for non shut-off tools. Its solenoid valve allows to shut-off the air when the cycle is complete, thus providing shut-off control with a non shut-off tool. It can also be used with a QXLH air hose with indicator light to signal the operator when to stop by releasing the throttle.

The **QC200** is used for error proofing with shut-off tools. Torque accuracy is dependent upon the capability of the selected pneumatic tool for the application.

## Principes de fonctionnement

Le boîtier d'assistance qualité QC est conçu pour contrôler les erreurs (double vissage, vissage incomplet, mauvais engagement) et les cycles de vissage. C'est un système de vérification d'erreurs, il n'assure pas le contrôle ou la surveillance du couple.

Le **QC100** est destiné aux outils sans coupure d'air automatique. Son électro-vanne permet de stopper l'air lorsque le cycle est terminé afin d'assurer une coupure d'air automatique sur des outils dépourvus de cet équipement. Il peut aussi être utilisé avec le flexible pneumatique QXLH doté d'une lampe témoin qui signale à l'opérateur le moment où il doit relâcher la gâchette.

Le **QC200** est utilisé pour contrôler les erreurs avec des outils à coupure d'air automatique, l'exactitude du couple dépendant de l'outil sélectionné.

## Grundlegende Informationen zum Betrieb

Der QC-Qualifikator wurde als Hilfe bei der Fehlererkennung und Schrauben-Gruppenzählung bei Schraubmontagen mit Druckluftwerkzeugen entwickelt. Der QC-Qualifikator ist ein Fehlererkennungssystem, das keine Drehmomentregelung oder Drehmomentmessung liefert.

Der **QC100** ist für normale Drehschrauber ohne Abschaltung entwickelt. Das dazugehörige Abschaltventil erlaubt ein Abschalten des Werkzeuges, wenn der Schraubzyklus abgeschlossen wurde - somit kann aus einem Drehschrauber ein Abschaltschraubsystem konfiguriert werden. Zusätzlich kann die QXLH Druckleitung verwendet werden, die am Werkzeugeinlass durch eine Signaldiode (rot/grün) als Schraubzyklenindikation dient.

Der **QC200** dient zur Fehlererkennung bei Abschaltschraubern. Die Drehmomentgenauigkeit ist abhängig von der Fähigkeit des ausgewählten Druckluftwerkzeuges bzw. der Genauigkeit der Abschaltkupplung.

## Fundamentos de funcionamiento

El cualificador de procesos QC está diseñado para la comprobación de errores y el recuento de lotes para la instalación de elementos de fijación roscados. Es un sistema de comprobación de errores y no proporciona supervisión ni control sobre el par.

El **QC100** está diseñado para herramientas sin corte de aire. La válvula solenoide permite desconectar el aire cuando se ha completado el ciclo, proporcionando un mejor control para este tipo de herramientas. Se puede usar también con el indicador luminoso QXLH para la manguera y así avisar al operario que libere el gatillo.

El **QC200** se utiliza para la comprobación de errores con las herramientas con corte de aire. La precisión del par depende de la capacidad de la herramienta neumática seleccionada para la aplicación.

## Funzionamento di base

Il qualificatore di processo QC è progettato per aiutare nel rilevamento degli errori e nel conteggio di batch per il montaggio di dispositivi di fissaggio filettati. Il qualificatore QC è un sistema di controllo errori e non offre controllo o monitoraggio della coppia.

Il **QC100** è stato progettato per gli utensili senza stacco dell'aria. L'elettrovalvola consente di staccare l'aria quando il ciclo è stato completato, questa provvede allo stacco dell'aria anche con utensili senza stacco aria. Può anche essere usata con il QXLH, tubo aria con segnale luminoso, per la segnalazione all'operatore quando è il momento di rilasciare il pulsante d'avviamento.

Il **QC200** viene utilizzato nel controllo errori con utensili con arresto. La precisione della coppia dipende dalle prestazioni dell'utensile pneumatico scelto per l'applicazione.

## Optional air hose with indicator light

### Option flexible pneumatique avec lampe témoin

### Wahlweise freigestellter Luftschlauch mit Anzeigelampe

### Manguera neumática opcional con indicador luminoso

### Equipaggiamento a richiesta - Tubo aria con luce spia

		Ref.
	↔	
1/4"	5.0 meters	<b>QXLH-16-14</b>
1/4"	7.5 meters	<b>QXLH-25-14</b>
3/8"	5.0 meters	<b>QXLH-16-38</b>
3/8"	7.5 meters	<b>QXLH-25-38</b>



**Accessory**



**Common Accessories for Fastening and Drilling Tools**  
**Accessoires communs pour outils de vissage et de perçage**  
**Zubehör für Schrauber und Bohrmaschinen**  
**Accesorios comunes para herramientas de montaje y taladros**  
**Accessori comuni per utensili d'assemblaggio e trapani**

<p>Horizontal hanger (for pistol models only)          Suspension horizontale (pour modèles à poignée revolver)          Horizontal-Aufhänger (nur für Modelle mit Pistolengriff)          Suspensión horizontal (sólo para modelos tipo pistola)          Disp. sospensione orizzontale (solo per modelli a pistola)</p>	
<p>Horizontal hanger (for angle models only)          Suspension horizontale (pour modèles d'angle uniquement)          Horizontal-Aufhänger (nur für Winkelschrauber)          Suspensión horizontal (sólo para modelos angulares)          Disp. sospensione orizzontale (solo per modelli ad angolo)</p>	
<p>Vertical hanger (for straight and angle models only)          Suspension verticale (pour modèles droits et d'angle uniquement)          Vertikal-Aufhänger (nur für gerade und Winkelausführung)          Suspensión vertical (sólo para modelos rectos y angulares)          Disp. sospensione verticale (solo per modelli diritti e ad angolo)</p>	
<p>Dead handle          Poignée auxiliaire          Hilfsgriff          Mango de sujeción          Impugnatura ausiliaria</p>	
<p>Piped away exhaust kit (for straight models only)          Kit d'échappement canalisé (pour modèles droits uniquement)          Abluftschlauch-Satz (nur für gerade Ausführung)          Juego escape remoto (sólo para modelos rectos)          Kit scarico convogliato (solo per modelli diritti)</p>	
<p>Exhaust hose          Gaine d'échappement          Abluftschlauch          Manguera de escape          Tubo di scarico</p>	
<p>Comfort grip (straight and angle / lever)          Poignée confort (modèles droits et d'angle à levier)          Komfortgriff (für gerade und Winkelausführung mit Hebelstart)          Empuñadura comfort (para modelos rectos y angulares con palanca)          Impugnatura comfort (per modelli diritti e ad angolo a leva)</p>	
<p>Comfort grip (pistol screwdrivers)          Poignée confort (pour visseuses à poignée revolver)          Komfortgriff (für Drehschrauber mit Pistolengriff)          Empuñadura comfort (para atornilladores tipo pistola)          Impugnatura comfort (per cacciaviti / impugnatura a pistola)</p>	
<p>Replacement clutch adjusting key (shut-off and cushion clutch models)          Clé de réglage du limiteur de couple (limiteur à coupure d'air et à billes)          Kupplungs-Einstellschlüssel (für Abschalt- und Rutschkupplung)          Llave de ajuste del embrague (sólo para modelos con parada auto. y embrague ajustable)          Chiavetta regolazione frizione (per frizione a cuscono e con blocco)</p>	
<p>Clutch springs / min torque          Ressorts de limiteur de couple / couple mini          Kupplungsfeder / kleinster Drehmomentbereich          Muelles de embrague / Par mín.          Molle frizione / coppia min.</p>	

**For Q2 screwdrivers only – Pour visseuses Q2 uniquement**  
**Nur für Q2 Drehschrauber – Sólo para atornilladores Q2 – Solo per cacciaviti Q2**

**Q2**  
**Series**

<p>Color differentiating components: pistol buttplate (for pistol models)          Marquage de couleur pour différenciation des appareils: embase de poignée pour modèles revolver          Farbige Komponenten zur Unterscheidung der Werkzeuge: Unterteil des Pistolengriffs          Componentes con color diferente : tapa identificativa (para modelos de pistola)          Componenti con colori differenziati: base dell'impugnatura nei modelli a pistola</p>	<p>TRP-B-R (orange)          TRP-B-G (green)          TRP-B-B (blue)          TRP-B-Y (light grey)</p>
<p>Color differentiating components: flanged adjustment cover (for straight models)          Marquage de couleur pour différenciation des appareils: Bride avant à profil relevé pour modèles droits          Farbige Komponenten zur Unterscheidung der Werkzeuge: Abdeckflansch der Kupplungseinstellung (gerade Ausführung)          Componentes con color diferente: brida identificativa (para modelos rectos)          Componenti con colori differenziati: flangia anteriore per i modelli diritti</p>	<p>TRH-40-23-R (orange)          TRH-40-23-G (green)          TRH-40-23-B (blue)          TRH-40-23-Y (light grey)</p>
<p>Color differentiating components: non-flanged adjustment cover (for straight models)          Marquage de couleur pour différenciation des appareils: Bride avant à profil droit pour modèles droits          Farbige Komponenten zur Unterscheidung der Werkzeuge: Abdeckung (ohne Flansch) der Kupplungseinstellung (gerade Ausführung)          Componentes con color diferente: brida identificativa sin contorno ergonómico(para modelos rectos)          Componenti con colori differenziati: per i modelli diritti senza flangia</p>	<p>TRH-40-24-R (orange)          TRH-40-24-G (green)          TRH-40-24-B (blue)          TRH-40-24-Y (light grey)</p>



Q2 Series	41 Series	5 Series	7 Series	8 Series	9 Series	LD Series	BALD Series	Power Pulse	P33 Series
TRP-A365	48934	7RA-A366	7RA-A366	—	—	124621	124621	EQ106P-365	118303
3RA-365 (angle drills only)	48934	6WS-366	6WS-366	8SL-366	9SL-366	—	129851 (except 1202)	—	—
7L-365	IR48426-1	5RL-365	7L-365	7L-365	—	118303	118303	EQ106S-365 (except 900, 1100, 1900 and 3000)	128065
—	48931	728N-A48 + 5A-49 (x2)	R1A-A48 + 7A-49 (x2)	9SL-48 + 8SL-A60	9SL-48 + 9SL-A60	—	—	—	131899
LG1-K284	—	5L-K184	7L-K284	—	—	—	—	—	—
3RL-284	46490 + 46477	—	—	—	—	—	—	—	—
—	—	CG-5RL (except angle wrenches)	CG-7RL CG-7RLD (angle wrenches)	—	—	—	—	—	—
TRP-40-1 (small)	—	CG-5RA	CG-7RA	—	—	—	—	—	—
TRH-478	(standard screwdriver)	5C1-416	5C1-416	—	—	124397 (LD12, LD22)	124397 (BALD12, 22)	04352241 (1.5 mm) 04355012 (2 mm) 04352258 (5 mm)	—
—	—	—	—	—	—	124542 (1 Nm : LD12 and BALD12, except 1202) 419300 (1.5 Nm : LD22 & BALD22, except 2203) 127407 (3 Nm : LD/BALD32)	—	—	—



Variacor air hose universal joint – Raccord tournant Variacor – Lufteinlaß-Drehgelenk Variacor – Conexión giratoria Variacor – Raccordo girevole Variacor

Ø A	Ø B	Ref.
1/8" NPT	1/4" BSP	DV7MN18FB14
1/4" NPT	1/4" BSP	DV7MN14FB14
1/4" BSP	1/4" BSP	DV7MB14FB14
3/8" BSP	3/8" BSP	DV11MB38FB38

**Accessory**



**Common Accessories for Angle Wrenches only**  
**Accessoires communs pour clés d'angle uniquement**  
**Zubehör nur für Winkelschrauber**  
**Accesorios comunes sólo para llaves angulares**  
**Accessori comuni per chiavi ad angolo**



TRL-415-1  
to TRL-415-5

	<b>Q2 Series</b>	<b>41 Series</b>	<b>5 Series</b>	<b>7 Series</b>	<b>8 Series</b>	<b>9 Series</b>
1/4" square drive spindle Broche carrée 1/4" 1/4" Vierkant-Antriebsspindel 1/4" cuadradillo de salida del eje Albero quadro 1/4"	TRL2-A607-S4	48404-1	141A9-A607-1/4 (6.3 Nm max.)	141A9-A607-1/4 (6.3 Nm max.)	—	—
3/8" square drive spindle Broche carrée 3/8" 3/8" Vierkant-Antriebsspindel 3/8" cuadradillo de salida del eje Albero quadro 3/8"	TRL2-A607-S6	48405-1	141A12-A607	141A12-A607	—	—
1/4" hex bit holder spindle Broche porte lame hexagonale 1/4" 1/4" Skt. Klingenhalter-Spindel 1/4" Hex eje portapuntas Albero porta punta ex. 1/4"	TRL2-A607-Q4	48402-1	5L2C3-B586	5L2C3-B586	—	—
1/4" insert bit holder spindle Broche porte embout hexagonal 1/4" 1/4" Skt. Einsteckklingenhalter-Spindel 1/4" Hex eje para puntas cortas Albero porta inserti ex. 1/4"	TRL2-A607-H4	48403-1	5L2C4-B386	5L2C4-B386	—	—
150 mm angle head extension Allonge de renvoi d'angle de 150 mm 150 mm Winkelkopf-Verlängerung Extensión cabeza angular 150 mm Assieme prolunga testa angolo 150 mm	—	—	—	—	8SL-A327-6	8SL-A327-6
3/4" flush head socket * Douille hexagonale femelle 3/4" sur plats * 3/4" Integrierte Sechskant-Steckschlüssel * Bocas hexagonales integradas 3/4" * Bussole integrate da 3/4" *	—	—	—	—	—	182A88-807 (83 angle head)
13 mm flush head socket * Douille hexagonale femelle 13 mm sur plats * 13 mm Integrierte Sechskant-Steckschlüssel * Bocas hexagonales integradas 13 mm * Bussole incassate 13 mm *	—	—	—	8SA34-807M (3D6) angle head	8SA34-807M (32 angle head)	182A13MF-807 (53 angle head)
15 mm flush head socket * Douille hexagonale femelle 15 mm sur plats * 15 mm Integrierte Sechskant-Steckschlüssel * Bocas hexagonales integradas 15 mm * Bussole incassate 15 mm *	—	—	—	—	182A15MF-807 (53 angle head)	—
17 mm flush head socket * Douille hexagonale femelle 17 mm sur plats * 17 mm Integrierte Sechskant-Steckschlüssel * Bocas hexagonales integradas 17 mm * Bussole incassate 17 mm *	—	—	—	—	8SA56-807M (53 angle head)	—
19 mm flush head socket * Douille hexagonale femelle 19 mm sur plats * 19 mm Integrierte Sechskant-Steckschlüssel * Bocas hexagonales integradas 19 mm * Bussole incassate 19 mm *	—	—	—	—	—	182A88-807 (83 angle head)
Color differentiating components: clutch housing adjustment cover Marquage couleur pour différencier les appareils: bague couvre réglage du limiteur de couple Farbige Komponenten zur Unterscheidung der Werkzeuge: Abdeckung der Kupplungseinstellung Componentes con color diferente: tapa de zona de ajuste del embrague Componenti con colori differenziati: flangia di protezione frizione	TRL-415-1 (gold) TRL-415-2 (red) TRL-415-3 (blue) TRL-415-4 (green) TRL-415-5 (lime green)	—	—	—	—	—

\* These sockets replace the standard square drive in the angle head.

\* Ces douilles remplacent le carré entraîneur équipant la machine en std.

\* Diese Steckschlüssel ersetzen die Standard-Spindel im Winkelkopf.

\* Estas bocas reemplazan al eje estándar dentro la cabeza angular.

\* Queste bussole rimpiazzano l'albero standard delle teste ad angolo.































**Common Accessories for Drills only**  
**Accessoires communs pour perceuses uniquement**  
**Zubehör nur für Bohrmaschinen**  
**Accesorios comunes sólo para taladros**  
**Accessori comuni per trapani**



	<b>Q2 Series</b>	<b>5 Series</b>	<b>7 Series</b>	<b>P33 Series</b>
Chuck guard for straight and pistol models Câche mandrin pour modèles droits et revolver Bohrfutterschutz (für Modelle in gerader Ausführung und mit Pistolengriff) Protector de portabrocas (sólo para modelos rectos y de pistola) Protezione mandrino (solo per modelli diritti e a pistola)	<b>TRD-A961-S</b> (for 6 mm Ø) <b>TRD-A961</b> (for 10 mm Ø)	<b>5A-309</b> (for J, K, L ratio)	<b>7AH-K309</b> (for H, J, K, L ratio)	<b>128037</b> (for 8 mm Ø max.)
Square drive adapter - 3/8"-24 thread x 3/8" square Adaptateur carré entraîneur - filetage 3/8"-24 x carré 3/8" Steckschlüssel-Adapter (3/8"-24 Gewinde, 3/8" Vierkant) Adaptador de cuadradillo (rosca 3/8"-24 - 3/8" cuadradillo) Adattatore quadro (filetto 3/8"-24 / quadro 3/8")	<b>ROH-P212-3/8</b>	<b>ROH-P212-3/8</b>	<b>ROH-P212-3/8</b>	<b>ROH-P212-3/8</b>
Quick change screwdriver bit adapter - 3/8"-24 thread x 1/4" hex drive Adaptateur pour lame hexagonale 1/4" - filetage 3/8"-24 x mandrin rapide 1/4" Schnellwechsel-Adapter für Drehschrauberklingen (3/8"-24 x 1/4" Skt.-Einsteckende) Adaptador para puntas de cambio rápido (rosca 3/8"-24 - 1/4" hex) Adattatore a cambio rapido per punte cacciavite (filetto 3/8"-24 / ex 1/4")	<b>ROH-A925-4</b>	<b>ROH-A925-4</b>	<b>ROH-A925-4</b>	<b>ROH-A925-4</b>
Keyless chuck - Thread 3/8"-24 female / Industrial grade Mandrin automatique - filetage femelle 3/8"-24 / Gamme industrie Schnellspannfutter (3/8" - 24 Innengewinde) - Industrie-Ausführung Porta brocas sin llave (rosca 3/8"-24 hembra) - Grado industrial Mandrini autoserranti (femmina 3/8"-24) - Grado industriale			<b>CM-116688</b> (Ø 0-6 mm) <b>125605</b> (Ø 0-8 mm) <b>116689</b> (Ø 0-10 mm) <b>123194</b> (Ø 0-13 mm)	
Keyless chuck - Thread 3/8"-24 female / Standard grade Mandrin automatique - filetage femelle 3/8"-24 / Gamme standard Schnellspannfutter (3/8" - 24 Innengewinde) - Standard-Ausführung Porta brocas sin llave (rosca 3/8"-24 hembra) - Grado estándar Mandrini autoserranti (femmina 3/8"-24) - Grado standard			<b>KC10MM</b> (Ø 0-10 mm) <b>KC13MM</b> (Ø 0-13 mm)	
Collets for 9/32"-40 thread Pincas pour filetages 9/32"-40 (machines dont la référence se termine par A4) Spannzangen für alle Modelle mit der Endung A4 (9/32"-40) Pinzas para todos los modelos que terminan en A4 (rosca 9/32"-40) Pinze per tutti i modelli con finale A4 (filetto 9/32"-40)		<b>5L1A4-700-G2.4</b> (Ø 2.4 mm) <b>5L1A4-700-G3.2</b> (Ø 3.2 mm) <b>5L1A4-700-G4.0</b> (Ø 4.0 mm) <b>5L1A4-700-G4.8</b> (Ø 4.8 mm)	—	—
Self-locking lever (for straight models only) Lever de commande avec gâchette de sécurité (pour modèles droits uniquement) Sicherheitsventilhebel (für gerade Ausführung) Palanca auto-blocante (sólo para modelos rectos) Leva autoserrante (solo per modelli diritti)	—	—	—	<b>131655</b>

**Drill chucks and keys** (for replacement, supplied as standard with the drills)  
**Pour perceuses uniquement** (pour remplacement, fournis en standard avec les machines)  
**Bohrfutter und Bohrfutterschlüssel** (im Lieferumfang enthalten)  
**Portabrocas y llaves** (suministrados de serie)  
**Mandrini e chiavette** (forniti come standard)

	<b>Gear Ratio</b>	<b>Ø mm</b>			<b>Ref. No.</b>		<b>Ref. No.</b>
<b>Q2 Series</b>	—	0 - 6	3/8" - 24		<b>R0H-99</b>		<b>R1H-J253</b>
	—	0 - 10	3/8" - 24		<b>6A-99</b>		<b>R0J-J253</b>
<b>5 Series</b>	J, K, K2, L, L2	0 - 6	3/8" - 24		<b>R0H-99</b>		<b>R1H-J253</b>
	N, N2	0 - 10	3/8" - 24		<b>R1M-99</b>		<b>R1M-J253</b>
	5RA (L ratio)	0 - 10	3/8" - 24		<b>R1M-99</b>		<b>R1M-J253</b>
	5RA (N ratio)	2 - 13	3/8" - 24		<b>R0K-99</b>		<b>R1T-J253</b>
<b>7 Series</b>	H, J	0 - 6	3/8" - 24		<b>R00A-99</b>		<b>R00A-J253</b>
	K	0 - 10	3/8" - 24		<b>6A-99</b>		<b>R0J-J253</b>
	L, M, M3	0 - 10	3/8" - 24		<b>R1M-99</b>		<b>R1M-J253</b>
	N, N3, Q	2 - 13	3/8" - 24		<b>R0K-99</b>		<b>R1T-J253</b>
<b>P33 Series</b>	—	0 - 6	3/8" - 24		<b>117269</b>		<b>117271</b>
	—	0 - 8	3/8" - 24		<b>CM115-313</b>		<b>117271</b>
	—	0 - 10	3/8" - 24		<b>117311</b>		<b>117312</b>



Flanged mounting plate Bride de montage cannelée Flanschbefestigung Brida de soporte estriada Flangia di montaggio scanalata	QA4 / QA8  < 56 Nm QA4 / QA8  < 56 Nm	15EA-K48
	QA6 / QA8  70 / 90 Nm QA6 / QA8  115 / 150 Nm	GEM120-K48
Square mounting plate Plaque de montage cannelée Verzahnte Montageplatte Soporte de montaje estriada Piastra di montaggio scanalata	QA6 / QA8  < 56 Nm QA6 / QA8  < 91 Nm	GEA4-K48
	QA6 / QA8  70 / 90 Nm QA6 / QA8  115 / 150 Nm	DAM120-K48
Reaction bar kit Barre anti-réaction Reaktionsstab Kit de barra de reacción Kit barra di reazione	QA4  < 28 Nm QA4  46 Nm:	GEA15-K48 DEA120-K48
Maintenance and repair tool Outil pour la maintenance et la réparation Wartungs- und Reparaturwerkzeug Herramienta de mantenimiento y reparación Utensile per riparazione e manutenzione		GEA40-478

**Mounting plate for QA4 series**  
(for vertical or horizontal mounting)

**Bride de montage pour série QA4**  
(montage vertical ou horizontal)

**Flanschbefestigung für Baureihe QA4**  
(für Werkbank- und Wand-Montage)

**Brida de soporte para QA4**  
(montaje en banco y montaje mural)

**Flangia di montaggio per QA4**  
(montaggio a banco e a parete)

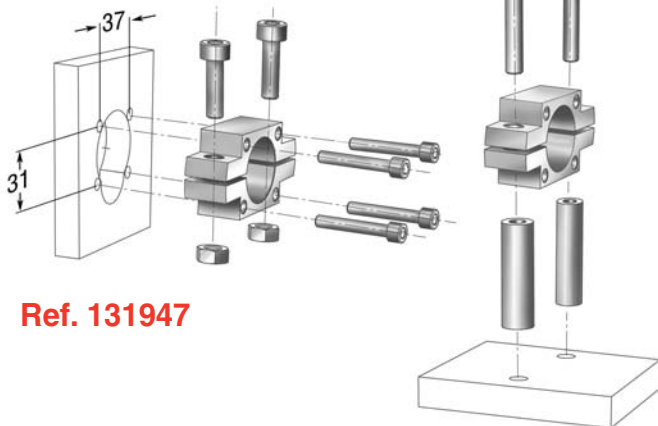

Ref. 131947



See our Torque Reaction Arms pages 95.  
 Voir nos bras anti-réaction page 95.  
 Mehr zu den Drehmomentarmen auf Seite 95.  
 Ver nuestros brazos de reacción de par en la pág. 95.  
 Vedi ns, bracci di reazione pagg. 95.

Notes

Lined area for taking notes.

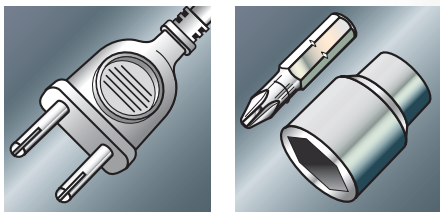

# Electric Fastening Tools

Outils d'Assemblage Électriques  
 Gleichstrombetriebene Montagewerkzeuge  
 Herramientas de Montaje eléctricas  
 Utensili elettrici per l'Assemblaggio

61

## VersaTec Series

Light Assembly Tools  
 Outils d'assemblage légers  
 Leichte MontageWerkzeuge  
 Ligero montaje herramientas  
 Leggero montaggio utensili

66

## Accessory

VersaTec Accessories  
 Accessoires pour VersaTec  
 Zubehör für VersaTec  
 Accesorios para VersaTec  
 Accessori per Versa Tec

68

## QE Series

Precision Fastening Tools  
 Visseuses de précision  
 Gesteuerte EC-Schrauber  
 Llaves de precisión  
 Avvitatori di precisione

74

## QE/QM Series

Electric Fixtured Wrenches  
 Broches de vissage électriques  
 Gesteuerte EC-Einbauspindeln  
 Husillos de atornillado eléctricos  
 Chiavi elettriche per installazioni fisse

84

## Accessory

Accessories for QE and QM Screwdrivers  
 Accessoires pour visseuses QE et QM  
 Zubehör für QE/QM Schrauber  
 Accesorios para atornilladores QE y QM  
 Accessori per cacciaviti elettrici QE e QM

85

## DC Control

Fastening Control System for QE & QM Series Electric Tools.  
 Système d'asservissement pour les séries électriques QE et QM.  
 Schraubersteuerungen für Schrauber der QE/QM- Serie.  
 Sistema de gestión de par para llaves eléctricas QE y QM.  
 Sistemi di gestione della coppia per chiavi elettriche QE e QM.



Versatec Electric Screwdrivers Selection Chart  
 Table de sélection des visseuses électriques VersaTec  
 VersaTec Elektro-Drehschrauber-Auswahltablelle  
 Cuadro de selección de atornilladores eléctricos VersaTec  
 Tabella di selezione delle cacciaviti elettrici VersaTec

**VersaTec  
Series**

230V

34V

Straight and pistol grip models • Modèles à poignée droite et révolver • Gerade Ausführung und Pistolengriff • Modelos con empuñadura recta y de pistola • Modelli con impugnatura diritta e a pistola

Model No.	1 Nm	2 Nm	3 Nm	4 Nm	5 Nm	6 Nm	Page
 EP1510E							62
EL1510E							62
EP2607E							62
EL2607E							62
EP4004E							62
ET4004E							62
EP1512S							63
EP1525S							63
EL1512S							63
EL1525S							63
EP2608S							63
EP2616S							63
EL2608S							63
EL2616S							63
EP4005S							63
EP4011S							63
ET4005S							63
ET4011S							63

230V

34V

Angle head models • Modèles à renvoi d'angle • Modelle mit Winkelkopf • Modelos con cabeza angular • Modelli con testa ad angolo

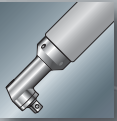
Model No.	1 Nm	2 Nm	3 Nm	4 Nm	5 Nm	6 Nm	Page
 EL1510E2S3							62
EL1510E2S5							62
EL4004E2S3							62
EL4004E2S5							62
EL1510E2S3							63
EL1510E2S5							63
EL4004E2S3							63
EL4004E2S5							63

24V

24V

Straight models • Modèles droits • Gerade Ausführung • Modelos con empuñadura recta • Modelli con impugnatura diritta

Model No.	1 Nm	2 Nm	3 Nm	4 Nm	5 Nm	6 Nm	Page
 EL0109E							65
EL0410E							65
EL1007E							65
EL0410BC-SS-ESD							65
EL0510BC-SS-ESD							65
EL0807BC-SS-ESD							65
EL1007BC-ESD							65
EL1007BC-SS-ESD							65



# VersaTec Series

230 VAC Electric Screwdrivers  
 Visseuses électriques 230 V  
 230V-Elektro-Drehschrauber  
 Atornilladores eléctricos de 230 V  
 Cacciaviti elettrici 230 V

## Standard Equipment

Pistol grip handle for all 4.5 Nm straight models

3 m power cable

Suspension bail

Poignée révolver amovible sur modèle droits de 4,5 Nm

Câble d'alimentation, longueur 3 m

Anse de suspension

Pistolengriff für 4,5 Nm-Modelle

Kabel, Länge 3 m

Aufhänger

Empuñadura de pistola para modelos de 4,5 Nm

Cable, longitud 3 m

Gancho de suspensión

Impugnatura a pistola montabile per modelli da 4,5 Nm

Cavo, lunghezza 3 m

Dispositivo di sospensione



EP2608S



ET4004E

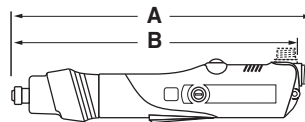

## 230 V

Straight and pistol grip models  
 Modèles à poignée droite et révolver  
 Gerade Ausführung und Pistolengriff  
 Modelos con empuñadura recta y de pistola  
 Modelli con impugnatura diritta e a pistola

Ref.							
	V	Nm	rpm	kg	mm	mm	in
<b>DC PUSH START — DEM. PAR POUSSÉE — SCHUBSTART — ARRANQUE POR EMPUJE — AVVIAMENTO A SPINTA</b>							
EP1510E <sup>(1)</sup>	AC230	0.6 - 1.7	1000	0.73	286	273	1/4
EP2607E <sup>(1)</sup>	AC230	1.2 - 2.9	700	0.73	286	273	1/4
EP4004E <sup>(1)</sup>	AC230	2.0 - 4.5	400	0.73	286	273	1/4
<b>DC LEVER START — DÉM. PAR LEVIER — HEBELSTART — ARRANQUE POR PALANCA — AVVIAMENTO A LEVA</b>							
EL1510E <sup>(1)</sup>	AC230	0.6 - 1.7	1000	0.73	286	273	1/4
EL2607E <sup>(1)</sup>	AC230	1.2 - 2.9	700	0.73	286	273	1/4
ET4004E <sup>(1)</sup>	AC230	2.0 - 4.5	400	0.73	286	273	1/4

(1) Add "-U" in model number for UK plug style, e.g. EP1510E-U

## 230 V

Angle head models  
 Modèles à renvoi d'angle  
 Modelle mit Winkelkopf  
 Modelos con cabeza angular  
 Modelli con testa ad angolo



EL4004E2S5

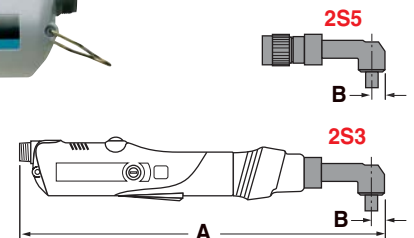

Ref.							
	V	Nm	rpm	kg	mm	mm	in
<b>DC LEVER START — DÉM. PAR LEVIER — HEBELSTART — ARRANQUE POR PALANCA — AVVIAMENTO A LEVA</b>							
EL1510E2S3 <sup>(1)</sup>	AC230	0.7 - 2.6	650	1.00	448	13.2	1/4
EL1510E2S5 <sup>(1)</sup>	AC230	0.7 - 2.6	650	1.00	448	13.2	1/4
EL4004E2S3 <sup>(1)</sup>	AC230	1.7 - 6.4	260	1.00	448	13.2	1/4
EL4004E2S5 <sup>(1)</sup>	AC230	1.7 - 6.4	260	1.00	448	13.2	1/4









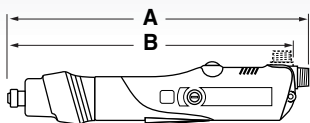





















(1) Add "-U" in model number for UK plug style, e.g. EP1510E-U



**34V**

Straight and pistol grip models  
 Modèles à poignée droite et révolver  
 Gerade Ausführung und Pistolengriff  
 Modelos con empuñadura recta y de pistola  
 Modelli con impugnatura diritta e a pistola











Ref.								
	V	Nm	rpm	kg	mm	mm	in	
<b>DC PUSH START — DEM. PAR POUSSÉE — SCHUBSTART — ARRANQUE POR EMPUJE — AVVIAMENTO A SPINTA</b>								
EP1512S		DC34 (EC34-ES)	0.6 - 1.7	1200	0.68	286	273	1/4 
EP1525S		DC34 (EC34-ES)	0.6 - 1.7	2500	0.68	286	273	1/4 
EP2608S		DC34 (EC34-ES)	1.2 - 2.9	800	0.68	286	273	1/4 
EP2616S		DC34 (EC34-ES)	1.2 - 2.9	1600	0.68	286	273	1/4 
EP4005S		DC34 (EC34-ES)	2.0 - 4.5	500	0.78	286	273	1/4 
EP4011S		DC34 (EC34-ES)	2.0 - 4.5	1100	0.78	286	273	1/4 
<b>DC LEVER START — DÉM. PAR LEVIER — HEBELSTART — ARRANQUE POR PALANCA — AVVIAMENTO A LEVA</b>								
EL1512S		DC34 (EC34-ES)	0.6 - 1.7	1200	0.68	286	273	1/4 
EL1525S		DC34 (EC34-ES)	0.6 - 1.7	2500	0.68	286	273	1/4 
EL2608S		DC34 (EC34-ES)	1.2 - 2.9	800	0.68	286	273	1/4 
EL2616S		DC34 (EC34-ES)	1.2 - 2.9	1600	0.68	286	273	1/4 
ET4005S		DC34 (EC34-ES)	2.0 - 4.5	500	0.78	286	273	1/4 
ET4011S		DC34 (EC34-ES)	2.0 - 4.5	1100	0.78	286	273	1/4 

**34V**

Angle head models  
 Modèles à renvoi d'angle  
 Modelle mit Winkelkopf  
 Modelos con cabeza angular  
 Modelli con testa ad angolo



Ref.							
	V	Nm	rpm	kg	mm	mm	in
<b>DC LEVER START — DÉM. PAR LEVIER — HEBELSTART — ARRANQUE POR PALANCA — AVVIAMENTO A LEVA</b>							
EL1525S2S3	DC34 (EC34-ES)	0.7 - 2.6	1600	0.95	448	13.2	1/4 
EL1525S2S5	DC34 (EC34-ES)	0.7 - 2.6	1600	0.95	448	13.2	1/4 
EL4011S2S3	DC34 (EC34-ES)	1.7 - 6.4	700	0.95	448	13.2	1/4 
EL4011S2S5	DC34 (EC34-ES)	1.7 - 6.4	700	0.95	448	13.2	1/4 



**VersaTec  
Series**

**Controllers for 34 V Screwdrivers**  
**Boîtiers de contrôle pour visseuses 34 volts**  
**Reglereinheit für 34 V-Drehschrauber**  
**Controladores para atornilladores de 34 V**  
**Controllori per cacciaviti 34 V**

**34 V**

**Ref No. EC34ES-1**  
*(EC34US-1 with UK plug style)*

230 V (AC) ⇔ 34 V (DC)

4.6 kg

220 mm x 115 mm x 102 mm

**34 V**

**Ref No. EC34ES-2**  
*(EC34US-2 with UK plug style)*

230 V (AC) ⇔ 34 V (DC)

4.8 kg

220 mm x 115 mm x 102 mm

**CPU controllers (34V) with SUB-D15 connector for PLC**  
**Boîtiers de contrôle CPU (34V) avec connecteur SUB-D15 pour API**  
**CPU-Steuerungen mit SUB-D15-Anschluss für SPS**  
**Controladores CPU (34 V) con conector SUB – DL15 para PLC**  
**Controllori CPU (34V) con connettore SUB-D15 per PLC**



- Manage several screwdrivers (4 in the example)
- Sequence screwdriver range.
- Programme tool changing.
- Count fastening cycles.
- Monitor tightening torques.
- Gestion de plusieurs visseuses (4 dans cet exemple).
- Séquencement de la gamme de vissage.
- Gestion des changements d'outils.
- Comptage des cycles de vissage.
- Surveillance des couples de serrage.
- Verwalten von mehreren Schraubern (4 Stück im Beispiel).
- Führung durch ein Verschraubungsprogramm.
- Bestimmung der Einschaltreihenfolge verschiedener Schrauber.
- Zählung der Schraubzyklen.
- Überwachungs des Anzugmoments.
- Gestión de varios atornilladores (por ejemplo 4)
- Gama de secuencia de atornillado.
- Cambio de programa en herramienta.
- Conteo de ciclos de atornillado.
- Verificación de pares de apriete.
- Gestione di più avvitatori ( 4 nell'esempio)
- Gestione sequenza avvitature
- Gestione cambio avvitatore
- Conteggio cicli avvitatura
- Controllo coppia serraggio

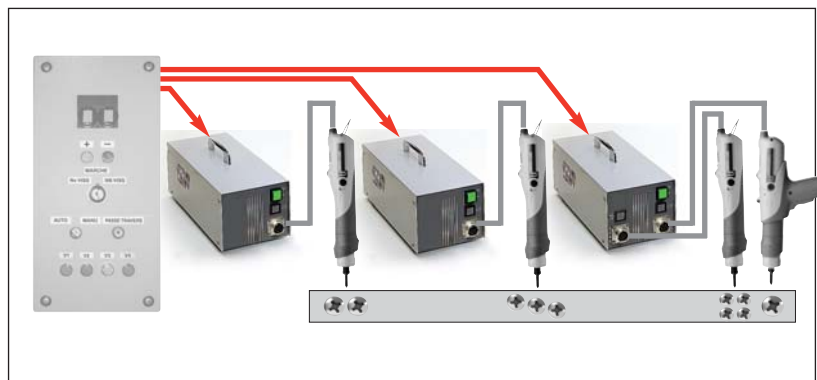

**Ref No. EC34ES-1-CPU**  
*(only european plug style available)*  
 230 V (AC) ⇔ 34 V (DC)  
 4.7 kg — 220 mm x 115 mm x 102 mm



**Ref No. EC34ES-2-CPU**  
*(only european plug style available)*  
 230 V (AC) ⇔ 34 V (DC)  
 4.9 kg — 220 mm x 115 mm x 102 mm



**24 V Low Torque Screwdrivers and Controllers**  
**Visseuses 24 V à bas couple et boîtiers de contrôle**  
**24 V-Drehschrauber mit niedrigem Drehmoment und Reglereinheit**  
**Atornilladores de 24 V de par bajo y controladores**  
**Cacciaviti 24 V a bassa coppia e controllori**

**VersaTec Series**



**Standard Equipment**

Two clutch springs

3 m power / control cable

Soft stop features on SS-ESD models

Deux ressorts de limiteur

Câble de connection au boîtier, longueur 3 m

Arrêt progressif sur modèles SS-ESD

2 Kupplungs-federn

Kabel, Länge 3 m

Soft-Stop-Merkmale für Modelle SS-ESD

2 Muelles de embrague

Cable, longitud 3 m

Función de parada suave para modelos SS-ESD

2 Molle della frizione

Cavo, lunghezza 3 m

Funzione di arresto progressivo per modelli SS-ESD



EL0410E

**24V**

Ref.	V	Nm	1 min. rpm	kg	mm	
<b>LEVER START — DÉM. PAR LEVIER — HEBELSTART — ARRANQUE POR PALANCA — AVVIAMENTO A LEVA</b>						
EL0109E	DC24 (EC24-E)	0.03 - 0.15	650-950	0.32	235	Ø 4 mm
EL0410E	DC24 (EC24-E)	0.06 - 0.50	750-1000	0.36	235	1/4" ⌀
EL1007E	DC24 (EC24-E)	0.55 - 1.2	500-700	0.36	235	1/4" ⌀

**ESD models**  
**Modèles ESD**  
**ESD-Modelle**  
**Modelos ESD**  
**Modelli ESD**



EL0510BC-SS-ESD



**24V**

Ref.	V	Nm	1 min. rpm	kg	mm	
<b>WITHOUT SOFT STOP — SANS ARRÊT PROGRESSIF — OHNE SOFT STOP — SIN PARADA SUAVE — SENZA ARRESTO PROGRESSIVO</b>						
EL1007BC-ESD	DC24 (EC24-ESD)	0.19 - 1.2	500-700	0.40	267	1/4" ⌀
<b>WITH SOFT STOP — AVEC ARRÊT PROGRESSIF — MIT SOFT STOP — CON PARADA SUAVE — CON ARRESTO PROGRESSIVO</b>						
EL0410BC-SS-ESD	DC24 (EC24-ESD)	0.19 - 0.40	700-1000	0.40	267	4 mm Ø
EL0510BC-SS-ESD	DC24 (EC24-ESD)	0.25 - 0.55	700-1000	0.40	267	4 mm Ø
EL0807BC-SS-ESD	DC24 (EC24-ESD)	0.45 - 0.95	500-700	0.40	267	4 mm Ø
EL1007BC-SS-ESD	DC24 (EC24-ESD)	0.55 - 1.2	500-700	0.40	267	4 mm Ø

**Ref No. EC24E**

(EC24-U with UK plug style)

230 V (AC) ⇔ 24 V (DC)

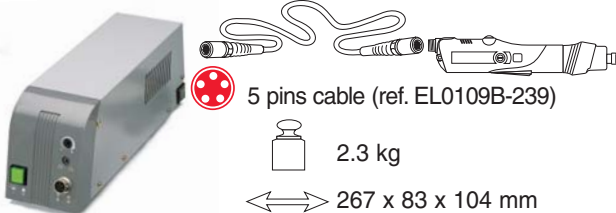

**Ref No. EC24-ESD**

(EC24-U-ESD with UK plug style)

230 V (AC) ⇔ 24 V (DC)

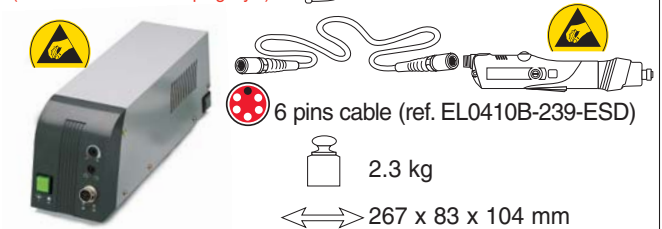

CPU controllers (24V) with SUB-D15 connector for PLC:  
 Boîtiers de contrôle CPU (24V) avec connecteur SUB-D15 pour API:  
 CPU-Steuerungen mit SUB-D15-Anschluss für SPS:  
 Controladores CPU con conector SUB-D15 para PLC:  
 Controllore CPU (24V) con connettore SUB-D15 per PLC:

**Ref No. EC24E-CPU**

(european plug style only)

**NOT AVAILABLE FOR ESD MODELS**

For 230 V and 34 V models  
 Pour modèles 230 V et 34 V  
 Für 230V und 34V-Elektro-Drehschrauber  
 Para los modelos de 230 V y 34 V  
 Per modelli 230 V e 34 V



Ref. No. **EP4007N-48**

Attachable pistol grip handle: for use with lever and push start models.

Poignée revolver amovible: pour utilisation sur tous les modèles avec mise en route par levier ou par poussée.

Pistolengriff: für den Einsatz bei allen Modellen mit Hebel- und Schubstart.

Empuñadura tipo pistola: para uso con modelos con arranque por palanca y por empuje.

Impugnatura a pistola montabile: da utilizzare con modelli con azionamento a leva ed a pulsante.

Suspension bails:

- Vertical: Ref. No. **EP4007N-365**
- Horizontal: Ref. No. **EP4007N-366**

Anneaux de suspension:

- Vertical, réf. **EP4007N-365**
- Horizontal, réf. **EP4007N-366**

Aufhängungen:

- Vertikal, Teile-Nr. **EP4007N-365**
- Horizontal, Teile-Nr. **EP4007N-366**

Ganchos de suspensión:

- Vertical, ref. **EP4007N-365**
- Horizontal, ref. **EP4007N-366**

Dispositivi di sospensione:

- Verticale, Cat. **EP4007N-365**
- Orizzontale, Cat. **EP4007N-366**

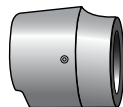
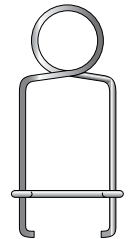

Ref. No. **EP4007N-123**

Low profile flange: smaller dimension flange (fitted as standard on pistol and angle models).

Bride à profil droit: bride de plus petites dimensions (livrée en standard sur les modèles d'angle et revolver)

Niedrigprofil-Flansch: Flansch mit kleineren Abmessungen (serien-mäßig bei Modellen mit Pistolengriff und Winkelkopf).

Brida de perfil bajo: brida de tamaño pequeño (estándar para modelos de pistola y angulares).

Flangia a basso profilo: flangia di minori dimensioni (standard per modelli a pistola e ad Angolo).

Ref. No. **VDS-511**

Light spring: Used for high torque models:

- 0,17 - 0,8 Nm for EP/EL1510E
- 0,22 - 1,0 Nm for EP/EL1512K/1525K

Ressort pour couple réduit: Utilisé pour les modèles haut couple  
 0,17 - 0,8 Nm, pour EP/EL1510E  
 0,22 - 1,0 Nm, pour EP/EL1512K/1525K.

Weiche Kupplungsfeder: für Modelle mit hohem Drehmoment.  
 0,17 - 0,8 Nm für EP/EL1510E  
 0,22 - 1,0 Nm für EP/EL1512K/1525K

Muelle ligero: utilizado para modelos de alto par.  
 0,17-0,8 Nm para EP/EL 1510E  
 0,22-1,0 Nm para EP/EL 1512K/1525K

Molla leggera: usata per modelli a coppia alta.  
 0,17-0,8 Nm per EP/EL1510E  
 0,22-1,0 Nm per EP/EL1512K/1525K



Ref. No. **EP4007N-516**

Torque adjusting wrench: used to externally adjust the torque without removing the flange.

Clé de réglage de couple: pour régler extérieurement le couple sans déposer la bride avant.

Einstellschlüssel: bei Modellen mit hohem Drehmoment kann ohne Entfernen des Flansches das Drehmoment von außen eingestellt werden.

Llave para ajustar el par: sirve para ajustar por fuera los modelos de par alto sin desmontar la brida.

Chiave per la regolazione della coppia: usata per la regolazione dall'esterno dei mod. a coppia alta senza smontare la flangia.

Angle head option

Option renvoi d'angle

Winkelkopf

Cabeza angular

Testa ad angolo

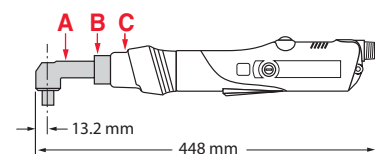

	2S3 	2S5 
<b>A</b>	<b>3RL23</b>	<b>3RL25</b>
<b>B</b>	<b>EL4007N2S5-AHC</b>	
<b>C</b>	<b>ET4007N2S5-580</b>	

For 34 V and 24 V models  
Pour modèles 34 V et 24 V  
Für 34V- und 24V-Elektro-Drehschrauber  
Para los modelos de 34 V y 24 V  
Per modelli 34 V e 24 V

24 V: Ref. No. **ES40T-249-2** for controller  
34 V: No. **EC29-249-2** for controller

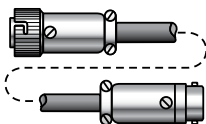

Extension cord, length 2 m: For use between tool and controller.

Rallonges, long. 2 m: Pour utilisation entre l'outil et le boîtier de contrôle

Verlängerungskabel, L 2 m Verbindet Werkzeug und Reglereinheit.

Cable prolongador, long. 2 m: para usar entre la herramienta y el controlador.

Cavo di prolunga, L 2 m: da utilizzare fra l'attrezzo e il controller.

Ref. No. **EC24-DC**

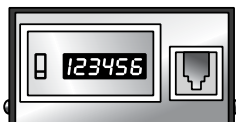

Digital counter: Available on special request. Digital display shows number of cycles. Includes cord to attach to controller.

Compteur numérique: sur demande spéciale. L'affichage numérique indique le nombre de cycles. Comprend un cordon pour connexion sur le boîtier de contrôle.

Digital-Zähler: Optional, auf besonderen Wunsch erhältlich. Anzeigt wird jeweils die Zyklenzahl. Einschließlich Modemkabel zum Anschluß an die Reglereinheit.

Contador digital: opcional. Se suministra por encargo especial. Indica el número de ciclos. Incluye cable para conectar al controlador.

Contatore Digitale: disponibile a richiesta speciale. Il display digitale mostra il numero di cicli. Include il cavo di trasmissione dati via modem da collegare al controllore.

For 24 V models  
Pour modèles 24 V  
Für 24V-Elektro-Drehschrauber  
Para los modelos de 24 V  
Per modelli 24 V

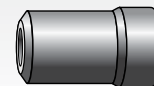

Ref. No. **DLW-5300**

Torque adjustment cover used for models EL1007E, EL0410E and EL0109E – Designed to ensure tamper proof torque adjustment.

Couvercle de protection du réglage de couple destiné aux modèles EL1007E, EL0410E et EL0109E – conçu pour garantir le réglage de couple contre les manipulations.

Kappe für Drehmomenteinstellung, für Modelle EL1007E, EL0410E und EL0109E. Diese Kappe wurde konstruiert, um eine gegen Eingriffe gesicherte Drehmomenteinstellung zu gewährleisten.

Cubierta para la regulación del par para modelos EL1007E, EL0410E y EL0109E – diseñada para garantizar la regulación del par de torsión contra golpes.

Copertura per la regolazione della coppia, per modelli EL1007E, EL0410E e EL0109E – progettata per garantire che la regolazione della coppia non venga manomessa.

Ref. No. **EL0109B-365**

Vertical hanger  
Suspension verticale  
Vertikal-Aufhänger  
Suspensión vertical  
Dispositivo sospensione verticale

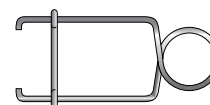



# QE Series Electric Screwdrivers Selection Chart

## Table de sélection des visseuses électriques QE

### QE EC-Schrauber-Auswahltable

#### Cuadro de selección de atornilladores eléctricos QE

#### Tabella di selezione delle cacciaviti elettrici QE

Pistol grip models • Modèles à poignée révolver • Modelle mit Pistolengriff • Modelos con empuñadura de pistola • Modelli con impugnatura a pistola

Model No.	4 Nm	8 Nm	12 Nm	16 Nm	20 Nm	24 Nm	Page
 QE2P.002P...							69-70
QE2P.003P...							69-70
QE2P.005P...							69-70
QE2P.007P...							69-70
QE2P.010P...							69-70
QE4PT010P...							69
QE4PT015P...							69
QE4PT020P...							69
QE4PT025P...							69

Inline Wrenches • Visseuses droites • Gerade Ausführung • Llaves en línea • Chiavi diritte

Model No.	40 Nm	80 Nm	120 Nm	160 Nm	200 Nm	240 Nm	Page
 QE2..002P...							71-72
QE2..003P...							71-72
QE2..005P...							71-72
QE2..007P...							71-72
QE2..010P...							71-72
QE4ST010B...							71
QE4TS010R...							72
QE4ST015B...							71
QE4TS015R...							72
QE4ST020B...							71
QE4TS020R...							72
QE6ST020F...							71
QE4ST025B...							71
QE4TS025R...							72
QE6ST028F...							71
QE6ST033F...							71
QE6ST050F...							71
QE8ST055F...							71
QE8ST070F...							71
QE8ST090F...							71
QE8ST150F...							71

Angle Wrenches • Visseuses d'angle • Winkelschrauber • Llaves angulares • Chiavi ad angolo

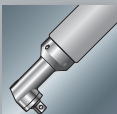
Model No.	40 Nm	80 Nm	120 Nm	160 Nm	200 Nm	240 Nm	Page
 QE2AL003P...							73
QE2AL005P...							73
QE2AL007P...							73
QE2AL010P...							73
QE4AT013P...							73
QE2AL015P...							73
QE4AT020P....							73
QE4AT027P....							73
QE6AT030P....							73
QE4AT034P....							73
QE6AT040P....							73
QE6AT055P....							73
QE8AT065P....							73
QE8AT070P....							73
QE6AT080P....							73
QE8AT090P....							73
QE8AT115P....							73
QE8AT150P....							73
QE8AT225P....							73
QE8AT400P....							73

Precision Electric Screwdrivers  
 Visseuses Électriques de précision  
 Gesteuerte EC-Schrauber  
 Atornilladores eléctricos de precisión  
 Cacciaviti elettrici di precisione

QE  
 Series



Standard  
 Equipment

Cycle status lights for immediate feedback on the fastening process

On board E-Prom for storage of calibration data, cycle counting, etc

Diodes d'état pour indication immédiate du couple appliqué

Puce électronique E-Prom incorporée (sauvegarde des données de calibration, cycles de vissage, etc)

Sofortige Anzeige des Verschraubungsstatus durch 3 Dioden

Eingebauter Datenchip mit Kalibrierwerten, Gesamtzyklusanzahl etc.

Luces de estado de ciclo para proporcionar información del proceso de atornillado

Tarjeta E-Prom para almacenar datos de calibración, conteo de ciclos, etc.

Indicatori luminosi per un immediato controllo processo avvitatura

Scheda E-Prom incorporata per una registrazione delle date di calibrazione, conteggio cicli etc...

Standard equipment, applicable for all QE HANDHELD tools.

Equipements standard pour toutes les visseuses PORTATIVES QE.

Standardausrüstung bei allen HANDGEHALTENEN QE-Werkzeugen.

Equipo estándar, aplicable para todas las herramientas PORTÁTILES de la serie QE.

Equipaggiamento standard adatto per tutti i modelli MANUALI serie QE.

Fastening Control System for QE Series Electric Tools, page 85.

Système d'asservissement pour les séries électriques QE, page 85.

Schraubersteuerungen für Schrauber der QE Serie, Seite 85.

Systema de gestión de par para llaves eléctricas QE, página 85.

Sistemi di gestione della coppia per chiavi elettriche QE, pag 85.



QE4PT015P10S04

QE2PT003P10Q04

Pistol grip / Trigger control  
 Poignée revolver / Démarrage par gâchette  
 Pistolengriff / Druckerstart  
 Empuñadura de pistola / Arranque por gatillo  
 Impugnatura a pistola / Avviamento a grilletto

Ref.	Nm	Nm Max.	1 min. rpm	kg	mm	mm	in	
<b>QE2 SERIES — SÉRIE QE2 — BAUREIHE QE2 — SERIE QE2</b>								
QE2PT002P10Q04	0.3 - 1.6	2	3000	0.66	250	19	1/4	M2-M4
QE2PT002P10S04	0.3 - 1.6	2	3000	0.66	242	19	1/4	M2-M4
QE2PT003P10Q04	0.6 - 2.4	3	2450	0.66	250	19	1/4	M2-M4
QE2PT003P10S04	0.6 - 2.4	3	2450	0.66	242	19	1/4	M2-M4
QE2PT005P10Q04	1 - 4	5	1700	0.66	250	19	1/4	M2-M4
QE2PT005P10S04	1 - 4	5	1700	0.66	242	19	1/4	M2-M4
QE2PT007P10Q04	1.3 - 5.6	7	1250	0.66	250	19	1/4	M2-M4
QE2PT007P10S04	1.3 - 5.6	7	1250	0.66	242	19	1/4	M2-M4
QE2PT010P10Q04	2 - 8	10	850	0.66	250	19	1/4	M4 - M5
QE2PT010P10S04	2 - 8	10	850	0.66	242	19	1/4	M4 - M5
<b>QE4 SERIES — SÉRIE QE4 — BAUREIHE QE4 — SERIE QE4</b>								
QE4PT010P10Q04	2.0 - 8.0	10	1820	1.20	243	?	1/4	M4 - M5
QE4PT010P10S04	2.0 - 8.0	10	1820	1.20	230	?	1/4	M4 - M5
QE4PT015P10Q04	3.0 - 12.0	15	1220	1.20	243	?	1/4	M5 - M6
QE4PT015P10S04	3.0 - 12.0	15	1220	1.20	230	?	1/4	M5 - M6
QE4PT020P10S06	4.0 - 16.0	20	900	1.20	234	?	3/8	M6 - M8
QE4PT025P10S06	5.0 - 20.0	25	710	1.20	234	?	3/8	M6 - M8

10



**QE  
Series**

**Precision Electric Screwdrivers**  
**Visseuses Électriques de précision**  
**Gesteuerte EC-Schrauber**  
**Atornilladores eléctricos de precisión**  
**Cacciaviti elettrici di precisione**



QE2PP005P10Q04



*Fastening Control System for QE Series  
Electric Tools, page 85.*









*Système d'asservissement pour les séries  
électriques QE, page 85.*

*Schraubersteuerungen für Schrauber der QE  
Serie, Seite 85.*









*Systema de gestión de par para llaves  
eléctricas QE, página 85.*

*Sistemi di gestione della coppia per chiavi  
elettriche QE, pag 85.*

**Pistol grip / Trigger + Push start control**  
**Poignée revolver / Démarrage par gâchette + Pousée**  
**Pistolengriff / Druckerstart + Schubstart**  
**Empuñadura de pistola / Arranque por gatillo + Empuje**  
**Impugnatura a pistola / Avviamento a grilletto + Spinta**

Ref.	 Nm	 Max. Nm	 1 min. rpm	 kg	 mm	 mm	 in	
<b>DC QE2 SERIES — SÉRIE QE2 — BAUREIHE QE2 — SERIE QE2</b>								
QE2PP002P10Q04	0.3 - 1.6	2	3000	0.66	250	19	1/4	M2-M4
QE2PP002P10S04	0.3 - 1.6	2	3000	0.66	242	19	1/4	M2-M4
QE2PP003P10Q04	0.6 - 2.4	3	2450	0.66	250	19	1/4	M2-M4
QE2PP003P10S04	0.6 - 2.4	3	2450	0.66	242	19	1/4	M2-M4
QE2PP005P10Q04	1 - 4	5	1700	0.66	250	19	1/4	M2-M4
QE2PP005P10S04	1 - 4	5	1700	0.66	242	19	1/4	M2-M4
QE2PP007P10Q04	1.3 - 5.6	7	1250	0.66	250	19	1/4	M2-M4
QE2PP007P10S04	1.3 - 5.6	7	1250	0.66	242	19	1/4	M2-M4
QE2PP010P10Q04	2 - 8	10	850	0.66	250	19	1/4	M4-M5
QE2PP010P10S04	2 - 8	10	850	0.66	242	19	1/4	M4-M5

**Pistol grip / Push start control**  
**Poignée revolver / Démarrage par pousée**  
**Pistolengriff / Schubstart**  
**Empuñadura de pistola / Arranque por empuje**  
**Impugnatura a pistola / Avviamento a spinta**

Ref.	 Nm	 Max. Nm	 1 min. rpm	 kg	 mm	 mm	 in	
<b>DC QE2 SERIES — SÉRIE QE2 — BAUREIHE QE2 — SERIE QE2</b>								
QE2PS002P10Q04	0.3 - 1.6	2	3000	0.66	250	19	1/4	M2-M4
QE2PS002P10S04	0.3 - 1.6	2	3000	0.66	242	19	1/4	M2-M4
QE2PS003P10Q04	0.6 - 2.4	3	2450	0.66	250	19	1/4	M2-M4
QE2PS003P10S04	0.6 - 2.4	3	2450	0.66	242	19	1/4	M2-M4
QE2PS005P10Q04	1 - 4	5	1700	0.66	250	19	1/4	M2-M4
QE2PS005P10S04	1 - 4	5	1700	0.66	242	19	1/4	M2-M4
QE2PS007P10Q04	1.3 - 5.6	7	1250	0.66	250	19	1/4	M2-M4
QE2PS007P10S04	1.3 - 5.6	7	1250	0.66	242	19	1/4	M2-M4
QE2PS010P10Q04	2 - 8	10	850	0.66	250	19	1/4	M4-M5
QE2PS010P10S04	2 - 8	10	850	0.66	242	19	1/4	M4-M5

Precision Electric Screwdrivers  
 Visseuses Électriques de précision  
 Gesteuerte EC-Schrauber  
 Atornilladores eléctricos de precisión  
 Cacciaviti elettrici di precisione

QE  
 Series



QE2SL005P10Q04



QE4ST010B21Q04

Inline Wrenches / Lever control  
 Visseuses droites / Démarrage par levier  
 Gerade Ausführung / Hebelstart  
 Llaves en línea / Arranque por palanca  
 Chiavi diritte / Avviamento a leva

Ref.	Nm	Max. Nm	rpm	kg	mm	Floating spindle (mm)	in			
<b>QE2 SERIES — SÉRIE QE2 — BAUREIHE QE2 — SERIE QE2</b>										
QE2SL002P10Q04	0.3 - 1.6	2	3000	0.60	250	—	—	22	1/4"	M2-M4
QE2SL002P10S04	0.3 - 1.6	2	3000	0.60	242	—	—	22	1/4"	M2-M4
QE2SL002F32S06	0.3 - 1.6	2	3000	0.91	342	32	19	19	3/8"	M2-M4
QE2SL003P10Q04	0.6 - 2.4	3	2450	0.60	250	—	—	22	1/4"	M2-M4
QE2SL003P10S04	0.6 - 2.4	3	2450	0.60	242	—	—	22	1/4"	M2-M4
QE2SL003F32S06	0.6 - 2.4	3	2450	0.91	342	32	19	19	3/8"	M2-M4
QE2SL005P10Q04	1 - 4	5	1700	0.60	250	—	—	22	1/4"	M2-M4
QE2SL005P10S04	1 - 4	5	1700	0.60	242	—	—	22	1/4"	M2-M4
QE2SL005F32S06	1 - 4	5	1700	0.91	342	32	19	19	3/8"	M2-M4
QE2SL007P10Q04	1.3 - 5.6	7	1250	0.60	250	—	—	22	1/4"	M2-M4
QE2SL007P10S04	1.3 - 5.6	7	1250	0.60	242	—	—	22	1/4"	M2-M4
QE2SL007F32S06	1.3 - 5.6	7	1250	0.91	342	32	19	19	3/8"	M2-M4
QE2SL010P10Q04	2 - 8	10	850	0.60	250	—	—	22	1/4"	M4-M5
QE2SL010P10S04	2 - 8	10	850	0.60	242	—	—	22	1/4"	M4-M5
QE2SL010F32S06	2 - 8	10	850	0.91	342	32	19	19	3/8"	M4-M5
<b>QE4 SERIES — SÉRIE QE4 — BAUREIHE QE4 — SERIE QE4</b>										
QE4ST010B21S06 <sup>(1)</sup>	2 - 8	10	1820	1.20	386	40	19	25	3/8"	M4-M5
QE4ST010B20S06 <sup>(1)</sup>	2 - 8	10	1820	1.20	386	40	—	25	3/8"	M4-M5
QE4ST015B21S06 <sup>(1)</sup>	3 - 11	15	1220	1.20	386	40	19	25	3/8"	M5-M6
QE4ST015B20S06 <sup>(1)</sup>	3 - 11	15	1220	1.20	386	40	—	25	3/8"	M5-M6
QE4ST020B21S06 <sup>(1)</sup>	4 - 16	20	900	1.20	386	40	19	25	3/8"	M6-M8
QE4ST020B20S06 <sup>(1)</sup>	4 - 16	20	900	1.20	386	40	—	25	3/8"	M6-M8
QE4ST025B21S06 <sup>(1)</sup>	5 - 20	25	710	1.20	386	40	19	25	3/8"	M6-M8
QE4ST025B20S06 <sup>(1)</sup>	5 - 20	25	710	1.20	386	40	—	25	3/8"	M6-M8
<b>QE6 SERIES — SÉRIE QE6 — BAUREIHE QE6 — SERIE QE6</b>										
QE6ST020F41S06 <sup>(2)</sup>	4 - 16	20	1840	2.10	501	113	19	27	3/8"	M6-M8
QE6ST020F61S06 <sup>(2)</sup>	4 - 16	20	1840	2.10	544	144	38	27	3/8"	M6-M8
QE6ST028F41S06 <sup>(2)</sup>	6 - 22	28	1360	2.10	501	113	19	27	3/8"	M8
QE6ST028F61S06 <sup>(2)</sup>	6 - 22	28	1360	2.10	544	144	38	27	3/8"	M8
QE6ST033F41S06 <sup>(2)</sup>	7 - 26	33	1130	2.10	501	113	19	27	3/8"	M8
QE6ST033F61S06 <sup>(2)</sup>	7 - 26	33	1130	2.10	544	144	38	27	3/8"	M8
QE6ST050F41S08	10 - 40	50	760	2.10	501	113	19	27	1/2"	M10
QE6ST050F61S08	10 - 40	50	760	2.10	544	144	38	27	1/2"	M10
<b>QE8 SERIES — SÉRIE QE8 — BAUREIHE QE8 — SERIE QE8</b>										
QE8ST055F41S08	11 - 44	55	1470	3.00	557	109	19	30	1/2"	M10
QE8ST055F61S08	11 - 44	55	1470	3.00	608	141	38	30	1/2"	M10
QE8ST070F41S08	14 - 56	70	1160	3.00	557	109	19	30	1/2"	M10
QE8ST070F61S08	14 - 56	70	1160	3.00	608	141	38	30	1/2"	M10
QE8ST090F41S08	18 - 72	90	900	3.00	557	109	19	30	1/2"	M10
QE8ST090F61S08	18 - 72	90	900	3.00	608	141	38	30	1/2"	M10
QE8ST150F41S08	30 - 120	150	500	3.40	572	109	19	31	1/2"	M12-M14
QE8ST150F61S08	30 - 120	150	500	3.40	623	150	38	31	1/2"	M12-M14

(1) Also available with 1/4" (QE4.....Q04), 1/4" (QE4.....S04), and 1/2" (QE4.....S08) — (2) Also available with 1/2" (QE6.....S08).  
 (1) Également disponible avec entraîneur 1/4" (QE4.....Q04), 1/4" (QE4.....S04), et 1/2" (QE4.....S08) — (2) Dispo. avec entr. 1/2" (QE6.....S08).  
 (1) Auch erhältlich mit 1/4" (QE4.....Q04), 1/4" (QE4.....S04), und 1/2" (QE4.....S08) — (2) Auch erhältlich mit 1/2" (QE6.....S08).  
 (1) También disponible con 1/4" (QE4.....Q04), 1/4" (QE4.....S04), y 1/2" (QE4.....S08) — (2) También disponible con 1/2" (QE6.....S08).  
 (1) Disponibile anche con attacco 1/4" (QE4.....Q04), 1/4" (QE4.....S04), e 1/2" (QE4.....S08) — (2) Disponibile con attacco 1/2" (QE6.....S08).



**QE  
Series**

**Precision Electric Screwdrivers**  
**Visseuses Électriques de précision**  
**Gesteuerte EC-Schrauber**  
**Atornilladores eléctricos de precisión**  
**Cacciaviti elettrici di precisione**

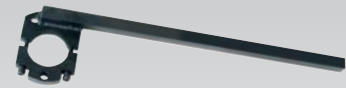

See QE accessories pages 84.  
 Accessoires gamme QE présentés page 84.  
 QE Zubehör finden Sie auf der Seite 84.  
 Ver la página 84 para los accesorios QE.  
 Vedere accessori QE a pagina 84.

**Inline Wrenches / Lever + Push start control**  
**Visseuses droites / Démarrage par levier + Poussée**  
**Gerade Ausführung / Hebelstart + Schubstart**  
**Llaves en línea / Arranque por palanca + Empuje**  
**Chiavi diritte / Avviamento a leva + Spinta**



QE2TS002P10Q04



Ref.	Nm	Max. Nm	rpm	kg	mm	mm	mm	mm
<b>DC QE2 SERIES — SÉRIE QE2 — BAUREIHE QE2 — SERIE QE2</b>								
QE2SP002P10Q04	0.3-1.6	2	3000	0.60	250	22	1/4	M2-M4
QE2SP002P10S04	0.3-1.6	2	3000	0.60	242	22	1/4	M2-M4
QE2SP003P10Q04	0.6-2.4	3	2450	0.60	250	22	1/4	M2-M4
QE2SP003P10S04	0.6-2.4	3	2450	0.60	242	22	1/4	M2-M4
QE2SP005P10Q04	1-4	5	1700	0.60	250	22	1/4	M2-M4
QE2SP005P10S04	1-4	5	1700	0.60	242	22	1/4	M2-M4
QE2SP007P10Q04	1.3-5.6	7	1250	0.60	250	22	1/4	M2-M4
QE2SP007P10S04	1.3-5.6	7	1250	0.60	242	22	1/4	M2-M4
QE2SP010P10Q04	2-8	10	850	0.60	250	22	1/4	M4-M5
QE2SP010P10S04	2-8	10	850	0.60	242	22	1/4	M4-M5

**Inline Wrenches / Push start control**  
**Visseuses droites / Démarrage par poussée**  
**Gerade Ausführung / Schubstart**  
**Llaves en línea / Arranque por empuje**  
**Chiavi diritte / Avviamento a spinta**



QE4TS015R11Q04



Ref.	Nm	Max. Nm	rpm	kg	mm	mm	mm	mm
<b>DC QE2 SERIES — SÉRIE QE2 — BAUREIHE QE2 — SERIE QE2</b>								
QE2TS002P11Q04	0.3-1.6	2	3000	0.57	250	22	1/4	M2-M4
QE2TS002P11S04	0.3-1.6	2	3000	0.57	242	22	1/4	M2-M4
QE2TS003P11Q04	0.6-2.4	3	2450	0.57	250	22	1/4	M2-M4
QE2TS003P11S04	0.6-2.4	3	2450	0.57	242	22	1/4	M2-M4
QE2TS005P11Q04	1-4	5	1700	0.57	250	22	1/4	M2-M4
QE2TS005P11S04	1-4	5	1700	0.57	242	22	1/4	M2-M4
QE2TS007P11Q04	1.3-5.6	7	1250	0.57	250	22	1/4	M2-M4
QE2TS007P11S04	1.3-5.6	7	1250	0.57	242	22	1/4	M2-M4
QE2TS010P11Q04	2-8	10	850	0.57	250	22	1/4	M4-M5
QE2TS010P11S04	2-8	10	850	0.57	242	22	1/4	M4-M5
<b>DC QE4 SERIES — SÉRIE QE4 — BAUREIHE QE4 — SERIE QE4</b>								
QE4TS010R11Q04	2-8	10	1820	1.20	363	25	1/4	M4-M5
QE4TS010R11S04	2-8	10	1820	1.20	343	25	1/4	M4-M5
QE4TS010R11S06	2-8	10	1820	1.20	343	25	3/8	M4-M5
QE4TS015R11Q04	3-12	15	1220	1.20	363	25	1/4	M5-M6
QE4TS015R11S04	3-12	15	1220	1.20	343	25	1/4	M5-M6
QE4TS015R11S06	3-12	15	1220	1.20	343	25	3/8	M5-M6
QE4TS020R11S06	4-16	20	900	1.20	343	25	3/8	M6-M8
QE4TS025R11S06	5-20	25	710	1.20	343	25	3/8	M6-M8



Precision Electric Screwdrivers  
 Visseuses Électriques de précision  
 Gesteuerte EC-Schrauber  
 Atornilladores eléctricos de precisión  
 Cacciaviti elettrici di precisione

QE  
 Series





Electric angle wrenches / Lever control  
 Visseuses d'angle électriques / Démarrage par levier  
 EC-Winkelschrauber / Hebelstart  
 Llaves angulares eléctricas / Arranque por palanca  
 Chiavi elettriche ad angolo / Avviamento a leva



Ref.	Nm	Max. Nm	1 min. rpm	kg	mm	mm	mm	in		
<b>DC QE2 SERIES — SÉRIE QE2 — BAUREIHE QE2 — SERIE QE2</b>										
QE2AL003PA1S04	0.8-3.2	4	1750	0.83	312	9.0	27	1/4		M2-M4
QE2AL005PA3S04	1-4	5	1590	0.95	318	13.0	34	1/4		M2-M4
QE2AL005PA3S06	1-4	5	1590	0.95	318	13.0	34	3/8		M2-M4
QE2AL005PA3Q04	1-4	5	1590	0.95	318	13.0	34	1/4		M2-M4
QE2AL005PA3H04	1-4	5	1590	0.95	318	13.0	34	1/4		M2-M4
QE2AL007PA3S06	1.4-5.6	7	1100	0.95	318	13.0	34	3/8		M2-M4
QE2AL007PA3Q04	1.4-5.6	7	1100	0.95	318	13.0	34	1/4		M2-M4
QE2AL007PA3H04	1.4-5.6	7	1100	0.95	318	13.0	34	1/4		M2-M4
QE2AL010PA3S04	2-8	10	730	0.95	318	13.0	34	1/4		M4-M5
QE2AL010PA3S06	2-8	10	730	0.95	318	13.0	34	3/8		M4-M5
QE2AL010PA3Q04	2-8	10	730	0.95	318	13.0	34	1/4		M4-M5
QE2AL010PA3H04	2-8	10	730	0.95	318	13.0	34	1/4		M4-M5
QE2AL015PA3S04	3-12	15	560	0.95	318	13.0	34	1/4		M4-M5
QE2AL015PA3S06	3-12	15	560	0.95	318	13.0	34	3/8		M4-M5
QE2AL015PA3Q04	3-12	15	560	0.95	318	13.0	34	1/4		M4-M5
QE2AL015PA3H04	3-12	15	560	0.95	318	13.0	34	1/4		M4-M5
<b>DC QE4 SERIES — SÉRIE QE4 — BAUREIHE QE4 — SERIE QE4</b>										
QE4AT013PA2Q04	3-10	13	1200	1.30	383	12.9	31.5	1/4		M5-M6
QE4AT013PA2H04	3-10	13	1200	1.30	383	12.9	31.5	1/4		M5-M6
QE4AT013PA2S04	3-10	13	1200	1.30	383	12.9	31.5	1/4		M5-M6
QE4AT013PA2S06	3-10	13	1200	1.30	383	12.9	31.5	3/8		M5-M6
QE4AT020PA2Q04	4-16	20	820	1.30	383	12.9	31.5	1/4		M6-M8
QE4AT020PA2H04	4-16	20	820	1.30	383	12.9	31.5	1/4		M6-M8
QE4AT020PA2S04	4-16	20	820	1.30	383	12.9	31.5	1/4		M6-M8
QE4AT020PA2S06	4-16	20	820	1.30	383	12.9	31.5	3/8		M6-M8
QE4AT027PA4S06	5-22	27	600	1.30	387	17.0	42.0	3/8		M8
QE4AT027PA4S08	5-22	27	600	1.30	387	17.0	42.0	1/2		M8
QE4AT034PA4S06	7-27	34	470	1.30	387	17.0	42.0	3/8		M8
QE4AT034PA4S08	7-27	34	470	1.30	387	17.0	42.0	1/2		M8
<b>DC QE6 SERIES — SÉRIE QE6 — BAUREIHE QE6 — SERIE QE6</b>										
QE6AT030PA2S06	6-24	30	1230	1.90	442	12.9	31.5	3/8		M8
QE6AT030PA4S08	6-24	30	1230	1.90	447	17.0	42.0	1/2		M8
QE6AT040PA4S06	8-32	40	910	1.90	447	17.0	42.0	3/8		M8
QE6AT040PA4S08	8-32	40	910	1.90	447	17.0	42.0	1/2		M8
QE6AT055PA5S08	11-44	55	650	1.90	453	21.5	44.7	1/2		M10
QE6AT080PA5S08	16-64	80	440	1.90	453	21.5	44.7	1/2		M10
<b>DC QE8 SERIES — SÉRIE QE8 — BAUREIHE QE8 — SERIE QE8</b>										
QE8AT065PA5S08	13-52	65	1200	2.90	516	21.5	44.7	1/2		M10
QE8AT070PA5S08	14-56	70	1100	2.90	516	21.5	44.7	1/2		M10
QE8AT090PA5S08	17-72	90	850	2.90	516	21.5	44.7	1/2		M10
QE8AT115PA6S08	23-92	115	660	2.90	520	24.3	50.0	1/2		M12
QE8AT150PA6S08	30-120	150	510	2.90	520	24.3	50.0	1/2		M12-M14
QE8AT225PA7S12	45-180	225	310	4.10	575	27.5	55.2	3/4		M16
QE8AT400FA8S12	80-320	400	170	6.00	635	33.3	68.5	3/4		M18

10

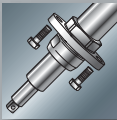
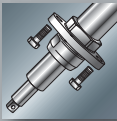
**QE / QM Series Electric Fixtured Wrenches Selection Chart**  
**Table de sélection des broches de vissage électriques QE et QM**  
**QE / QM EC-Einbauspindeln - Auswahltabelle**  
**Cuadro de selección de husillos de atornillado eléctricos QE y QM**  
**Tabella di selezione delle chiavi elettriche per installazioni fisse QE e QM**

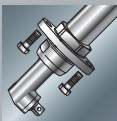
Model No.	100 Nm	200 Nm	300 Nm	400 Nm	500 Nm	600 Nm	Page
 QE2SC002F							75
QE2SC003F							75
QE2SC005F							75
QE2SC007F							75
QE2SC010F							75
QE4SC010B. ....							75
QE4SC015B. ....							75
QE4SC020B. ....							75
QE6SC020F. ....							76
QE4SC025B. ....							75
QE6SC028F. ....							76
QE6SC033F. ....							76
QE6SC050F. ....							76
QE8SC055F. ....							76
QE8SC070F. ....							76
QE8SC090F. ....							76
QE8SC150F. ....							76
QE8SC230F. ....							76
<b>Inline Wrenches</b> <b>Visseuses droites</b> <b>Gerade Ausführung</b> <b>Llaves en línea</b> <b>Chiavi diritte</b>							
 QM3SS008H. ....							79
QM3SS012H. ....							79
QM3SS016H. ....							79
QM3SS020H. ....							79
QM5SS035H. ....							80
QM5SS055H. ....							80
QM5SS090H. ....							80
QM7SS190H. ....							80
QM7SS220H. ....							80
QM9SS315H. ....							81
QM9SS435H. ....							81
QM9SS520H. ....							81
QM9SS650H. ....							81
QM9SS01KH62S16						250 - 800 Nm	81
QM9SS15CH62S24						250 - 1300 Nm	81
QM9SS18CH62S24						270 - 1500 Nm	81
QM9SS20CH62S24						300 - 1700 Nm	81
QM9SS22CH62S24						330 - 1900 Nm	81
<b>Inline Wrenches</b> <b>Visseuses droites</b> <b>Gerade Ausführung</b> <b>Llaves en línea</b> <b>Chiavi diritte</b>							
 QE6ZC020P. ....							77
QE6ZC028P. ....							77
QE6ZC033P. ....							77
QE6ZC050P. ....							77
QE8ZC055F. ....							77
QE8ZC070F. ....							77
QE8ZC090F. ....							77
QE8ZC150F. ....							77
<b>Offset wrenches</b> <b>Broches à tête déportée</b> <b>Modelle mit versetztem Abtrieb</b> <b>Llaves con eje descentrado</b> <b>Avvitatori con teste offset</b>							
 QE4AC013P. ....							78
QE4AC020P. ....							78
QE4AC027P. ....							78
QE6AC030P. ....							78
QE4AC034P. ....							78
QE6AC040P. ....							78
QQE6AC055P. ....							78
QE8AC065P. ....							78
QE8AC070P. ....							78
QE6AC080P. ....							78
QE8AC090P. ....							78
QE8AC115P. ....							78
QE8AC150P. ....							78
QE8AC225P. ....							78
QE8AC400P. ....							78
<b>Angle Wrenches</b> <b>Visseuses d'angle</b> <b>Winkelschrauber</b> <b>Llaves Angulares</b> <b>Chiavi ad Angolo</b>							

Electric Fixtured Wrenches  
Broches de vissage électriques  
Gesteuerte EC-Einbauspindeln  
Husillos de atornillado eléctricos  
Chiavi elettriche per installazioni fisse

QE  
Series



Standard  
Equipment

Cycle status lights for immediate feedback on the fastening process

On board E-Prom for storage of calibration data, cycle counting, etc

Mounting plate

Diodes d'état pour indication immédiate du couple appliqué

Puce électronique E-Prom incorporée (sauvegarde des données de calibration, cycles de vissage, etc)

Bride de montage

Sofortige Anzeige des Verschraubungsstatus durch 3 Dioden

Eingebauter Datenchip mit Kalibrierwerten, Gesamtzyklusanzahl etc.

Montageflansch

Luces de estado de ciclo para proporcionar información del proceso de atornillado.

Tarjeta E-Prom para almacenar datos de calibración, conteo de ciclos, etc.

Placa de montaje.

Luces de estado de ciclo para proporcionar información del proceso de atornillado.

Tarjeta E-Prom para almacenar datos de calibración, conteo de ciclos, etc.

Placa de montaje.

Standard equipment, applicable for all QE FIXTURED tools.

Equipements standard pour toutes les BROCHES DE VISSAGE QE

Standardausrüstung bei allen QE-Einbauwerkzeugen

Equipo estándar para aplicar a todas las herramientas QE no portátiles.

Equipaggiamento standard adatto per tutti i modelli installazione fissa serie QE



QE2 and QE4 Electric Fixtured Inline Wrenches  
Broches de vissage électriques droites QE2 et QE4  
QE2 und QE4 gerade EC-Einbauspindeln  
Husillos de atornillado eléctricos QE2 y QE4  
Chiavi elettriche diritte per installazioni fisse QE2 e QE4



QE2SC007F32S06



QE4SC010B20S06

Ref.	Nm	Max. Nm	rpm	kg	mm	mm	mm	in	
<b>QE2 SERIES — SÉRIE QE2 — BAUREIHE QE2 — SERIE QE2</b>									
QE2SC002F32S06	0.3 - 1.6	2	3000	0.91	342	32	19	3/8	M2 - M4
QE2SC003F32S06	0.6 - 2.4	3	2450	0.91	342	32	19	3/8	M2 - M4
QE2SC005F32S06	1 - 4	5	1700	0.91	342	32	19	3/8	M2 - M4
QE2SC007F32S06	1.3 - 5.6	7	1250	0.91	342	32	19	3/8	M2 - M4
QE2SC010F32S06	2 - 8	10	850	0.91	342	32	19	3/8	M4 - M5
<b>QE4 SERIES — SÉRIE QE4 — BAUREIHE QE4 — SERIE QE4</b>									
QE4SC010B21S06 <sup>(1)</sup>	2 - 8	10	1820	1.20	386	40	19	3/8	M4 - M5
QE4SC010B41S06 <sup>(1)</sup>	2 - 8	10	1820	1.20	437	74	19	3/8	M4 - M5
QE4SC010B20S06 <sup>(1)</sup>	2 - 8	10	1820	1.20	386	40	0	3/8	M4 - M5
QE4SC015B21S06 <sup>(1)</sup>	3 - 11	15	1220	1.20	386	40	19	3/8	M5 - M6
QE4SC015B41S06 <sup>(1)</sup>	3 - 11	15	1220	1.20	437	74	19	3/8	M5 - M6
QE4SC015B20S06 <sup>(1)</sup>	3 - 11	15	1220	1.20	386	40	0	3/8	M5 - M6
QE4SC020B21S06 <sup>(1)</sup>	4 - 16	20	900	1.20	386	40	19	3/8	M6 - M8
QE4SC020B41S06 <sup>(1)</sup>	4 - 16	20	900	1.20	437	74	19	3/8	M6 - M8
QE4SC020B20S06 <sup>(1)</sup>	4 - 16	20	900	1.20	386	40	0	3/8	M6 - M8
QE4SC025B21S06 <sup>(1)</sup>	5 - 20	25	710	1.20	386	40	19	3/8	M6 - M8
QE4SC025B41S06 <sup>(1)</sup>	5 - 20	25	710	1.20	437	74	19	3/8	M6 - M8
QE4SC025B20S06 <sup>(1)</sup>	5 - 20	25	710	1.20	386	40	0	3/8	M6 - M8

(1) Also available with 1/4" (QE4.....Q04), 1/4" (QE4.....S04), and 1/2" (QE4.....S08).

(1) Egalement disponible avec entraineur 1/4" (QE4.....Q04), 1/4" (QE4.....S04), et 1/2" (QE4.....S08).

(1) Auch erhältlich mit 1/4" (QE4.....Q04), 1/4" (QE4.....S04), und 1/2" (QE4.....S08).

(1) También disponible con 1/4" (QE4.....Q04), 1/4" (QE4.....S04), and 1/2" (QE4.....S08).

(1) Disponibile anche con attacco 1/4" (QE4.....Q04), 1/4" (QE4.....S04), e 1/2" (QE4.....S08).

QE2 & QE4 : 48.5 mm

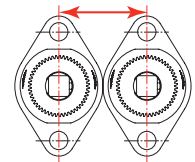

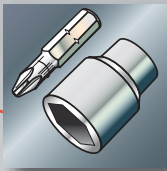

**QE  
Series**

**Electric Fixtured Wrenches**  
**Broches de vissage électriques**  
**Gesteuerte EC-Einbauspindeln**  
**Husillos de atornillado eléctricos**  
**Chiavi elettriche per installazioni fisse**











Fastening Control System for QE Series page 85.  
 Système d'asservissement pour les séries QE, page 85.  
 Schraubersteuerungen für der QE Serie, Seite 85.  
 Sistema de gestión de par para llaves QE, página 85.  
 Sistemi di gestione della coppia per chiavi QE, pag 85.

**QE6 and QE8 Electric Fixtured Inline Wrenches**  
**Broches de vissage électriques droites QE6 et QE8**  
**QE6 und QE8 gerade EC-Einbauspindeln**  
**Husillos de atornillado eléctricos QE6 y QE8**  
**Chiavi elettriche diritte per installazioni fisse QE6 e QE8**



QE8SC150F61S08

Ref.	 Nm	 Max. Nm	 1 min. rpm	 kg	 mm	 mm	 mm	 in	 in	
<b>QE6 SERIES — SÉRIE QE6 — BAUREIHE QE6 — SERIE QE6</b>										
QE6SC020F41S06 <sup>(1)</sup>	4-16	20	1840	2.1	501	113	19	3/8	□ M6-M8	
QE6SC020F61S06 <sup>(1)</sup>	4-16	20	1840	2.1	544	144	38	3/8	□ M6-M8	
QE6SC020F81S06 <sup>(1)</sup>	4-16	20	1840	2.1	594	195	38	3/8	□ M6-M8	
QE6SC028F41S06 <sup>(1)</sup>	6-22	28	1360	2.1	501	113	19	3/8	□ M8	
QE6SC028F61S06 <sup>(1)</sup>	6-22	28	1360	2.1	544	144	38	3/8	□ M8	
QE6SC028F81S06 <sup>(1)</sup>	6-22	28	1360	2.1	594	195	38	3/8	□ M8	
QE6SC033F41S06 <sup>(1)</sup>	7-26	33	1130	2.1	501	113	19	3/8	□ M8	
QE6SC033F61S06 <sup>(1)</sup>	7-26	33	1130	2.1	544	144	38	3/8	□ M8	
QE6SC033F81S06 <sup>(1)</sup>	7-26	33	1130	2.1	594	195	38	3/8	□ M8	
QE6SC050F41S08	10-40	50	760	2.1	501	113	19	1/2	□ M10	
QE6SC050F61S08	10-40	50	760	2.1	544	144	38	1/2	□ M10	
QE6SC050F81S08	10-40	50	760	2.1	594	195	38	1/2	□ M10	
<b>QE8 SERIES — SÉRIE QE8 — BAUREIHE QE8 — SERIE QE8</b>										
QE8SC055F41S08	11-44	55	1470	3.0	557	109	19	1/2	□ M10	
QE8SC055F61S08	11-44	55	1470	3.0	608	140	38	1/2	□ M10	
QE8SC055F81S08	11-44	55	1470	3.0	659	191	38	1/2	□ M10	
QE8SC070F41S08	14-56	70	1160	3.0	557	109	19	1/2	□ M10	
QE8SC070F61S08	14-56	70	1160	3.0	608	140	38	1/2	□ M10	
QE8SC070F81S08	14-56	70	1160	3.0	659	191	38	1/2	□ M10	
QE8SC090F41S08	18-72	90	900	3.0	557	109	19	1/2	□ M10	
QE8SC090F61S08	18-72	90	900	3.0	608	140	38	1/2	□ M10	
QE8SC090F81S08	18-72	90	900	3.0	659	191	38	1/2	□ M10	
QE8SC150F41S08	30-120	150	500	3.4	572	109	19	1/2	□ M12-M14	
QE8SC150F61S08	30-120	150	500	3.4	623	140	38	1/2	□ M12-M14	
QE8SC150F81S08	30-120	150	500	3.4	674	191	38	1/2	□ M12-M14	
QE8SC230F62S12 <sup>(2)</sup>	45-185	230	340	5.5	710	140	50	3/4	□ M16	
QE8SC230F82S12 <sup>(2)</sup>	45-185	230	340	5.5	761	191	50	3/4	□ M16	
QE8SC230F02S12 <sup>(2)</sup>	45-185	230	340	5.5	812	241	50	3/4	□ M16	
QE8SC230F22S12 <sup>(2)</sup>	45-185	230	340	5.5	853	291	50	3/4	□ M16	

- (1) Also available with 1/2" square drive (QE6.....S08).
- (2) Also available with 1" square drive (QE8.....S16).
- (1) Egalement disponible avec carré entraîneur 1/2" (QE6.....S08).
- (2) Egalement disponible avec carré entraîneur 1" (QE8.....S16).
- (1) Auch erhältlich mit 1/2"-Vierkant (QE6.....S08).
- (2) Auch erhältlich mit 1"-Vierkant (QE8.....S16).
- (1) También disponible con cuadrillo de 1/2" (QE6.....S08).
- (2) También disponible con cuadrillo de 1" (QE8.....S16).
- (1) Disponibile anche con attacco quadro da 1/2" (QE6.....S08).
- (2) Disponibile anche con attacco quadro da 1" (QE8.....S16).

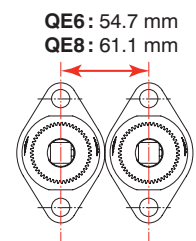

Electric Fixtured Wrenches  
 Broches de vissage électriques  
 Gesteuerte EC-Einbauspindeln  
 Husillos de atornillado eléctricos  
 Chiavi elettriche per installazioni fisse







QE  
 Series



**QE6 and QE8** Electric fixtured offset wrenches  
 Broches de vissage électriques à tête déportée **QE6 et QE8**  
**QE6 und QE8** EC-Einbauspindeln mit versetztem Abtrieb  
 Llaves eléctricas no portátiles con eje descentrado **QE6 y QE8**  
 Avvitatori elettrici per intallazione fisse con offset **QE6 e QE8**

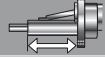
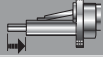

QE6ZC020P52S06

Ref.	 Nm	 Max. Nm	 1 min. rpm	 kg	 mm	 mm	 mm	 in	
<b>QE6 SERIES — SÉRIE QE6 — BAUREIHE QE6 — SERIE QE6</b>									
QE6ZC020P42S06	4-16	20	1840	2.5	664	130	51	3/8	M6-M8
QE6ZC020P52S06	4-16	20	1840	2.5	647	130	51	3/8	M6-M8
QE6ZC028P52S06	5-20	28	1360	2.5	647	130	51	3/8	M8
QE6ZC033P52S06	7-26	33	1130	2.5	647	130	51	3/8	M8
QE6ZC050P52S06	10-40	50	760	2.5	647	130	51	3/8	M10
<b>QE8 SERIES — SÉRIE QE8 — BAUREIHE QE8 — SERIE QE8</b>									
QE8ZC055F52S06 <sup>(1)</sup>	11-44	55	1470	3.0	723	130	51	3/8	M10
QE8ZC070F62S08 <sup>(1)</sup>	14-56	70	1160	3.0	786	194	51	1/2	M10
QE8ZC070F82S08 <sup>(1)</sup>	14-56	70	1160	3.0	837	245	51	1/2	M10
QE8ZC070F02S08 <sup>(1)</sup>	14-56	70	1160	3.0	888	295	51	1/2	M10
QE8ZC070F22S08 <sup>(1)</sup>	14-56	70	1160	3.0	939	346	51	1/2	M10
QE8ZC090F62S08 <sup>(1)</sup>	18-72	90	900	4.0	786	194	51	1/2	M10
QE8ZC090F82S08 <sup>(1)</sup>	18-72	90	900	4.0	837	245	51	1/2	M10
QE8ZC090F02S08 <sup>(1)</sup>	18-72	90	900	4.0	888	295	51	1/2	M10
QE8ZC090F22S08 <sup>(1)</sup>	18-72	90	900	4.0	939	346	51	1/2	M10
QE8ZC150F62S08 <sup>(1)</sup>	30-120	150	500	4.0	786	194	51	1/2	M12-M14
QE8ZC150F82S08 <sup>(1)</sup>	30-120	150	500	4.0	837	245	51	1/2	M12-M14
QE8ZC150F02S08 <sup>(1)</sup>	30-120	150	500	4.0	888	295	51	1/2	M12-M14
QE8ZC150F22S08 <sup>(1)</sup>	30-120	150	500	4.0	939	346	51	1/2	M12-M14

(1) Also available with 3/4" square drive (QE8.....S12).

(2) Also available with 1" square drive (QE8.....S16).

(1) Egalement disponible avec carré entraîneur 3/4" (QE8.....S12).

(2) Egalement disponible avec carré entraîneur 1" (QE8.....S16).

(1) Auch erhältlich mit 3/4"-Vierkant (QE8.....S12).

(2) Auch erhältlich mit 1"-Vierkant (QE8.....S16).

(1) También disponible con cuadrilla de 3/4" (QE8.....S12).

(2) También disponible con cuadrilla de 1" (QE8.....S16).

(1) Disponibile anche con attacco quadro da 3/4" (QE8.....S12).

(2) Disponibile anche con attacco quadro da 1" (QE8.....S16).

QE6 : 35.0 mm

QE8 : 44.7 mm

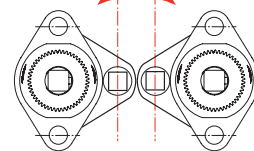

See accessories page 84.  
 Accessoires présentés page 84.  
 Zubehör finden Sie auf der Seite 84.  
 Ver la página 84 para los accesorios.  
 Vedere accessori a pagina 84.



**QE  
Series**

**Electric Fixtured Wrenches**  
**Broches de vissage électriques**  
**Gesteuerte EC-Einbauspindeln**  
**Husillos de atornillado eléctricos**  
**Chiavi elettriche per installazioni fisse**



*Fastening Control System for QE Series  
Electric Tools, page 85.*

*Système d'asservissement pour les séries  
électriques QE, page 85.*

*Schraubersteuerungen für Schrauber der QE  
Serie, Seite 85.*









*Systema de gestión de par para llaves  
eléctricas QE, página 85.*

*Sistemi di gestione della coppia per chiavi  
elettriche QE, pag 85.*

**QE4, QE6 & QE8 Electric Fixtured Angle Wrenches**  
**Broches de vissage d'angle électriques QE4, QE6 et QE8**  
**QE4, QE6 & QE8 EC-Einbauspindeln mit Winkelkopf**  
**Llaves angulares fijas eléctricas QE4, QE6 y QE8**  
**Chiavi elettriche ad angolo per installazioni fisse QE4, QE6 e QE8**

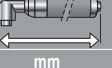

QE6AC040FA4S06

Ref.	 Nm	 Nm Max.	 1 min. rpm	 kg	 mm	 mm	 mm	 in	
<b>QE4 SERIES — SÉRIE QE4 — BAUREIHE QE4 — SERIE QE4</b>									
QE4AC013BA2H04	3-10	13	1200	1.3	383	12.9	31.5	1/4	M5 - M6
QE4AC013BA2Q04	3-10	13	1200	1.3	383	12.9	31.5	1/4	M5 - M6
QE4AC013BA2S04	3-10	13	1200	1.3	383	12.9	31.5	1/4	M5 - M6
QE4AC013BA2S06	3-10	13	1200	1.3	383	12.9	31.5	3/8	M5 - M6
QE4AC020BA2H04	4-16	20	820	1.3	383	12.9	31.5	1/4	M6 - M8
QE4AC020BA2Q04	4-16	20	820	1.3	383	12.9	31.5	1/4	M6 - M8
QE4AC020BA2S04	4-16	20	820	1.3	383	12.9	31.5	1/4	M6 - M8
QE4AC020BA2S06	4-16	20	820	1.3	383	12.9	31.5	3/8	M6 - M8
QE4AC027BA4S06	5-22	27	600	1.3	387	17.0	42.0	3/8	M8
QE4AC027BA4S08	5-22	27	600	1.3	387	17.0	42.0	1/2	M8
QE4AC034BA4S06	7-27	34	470	1.3	387	17.0	42.0	3/8	M8
QE4AC034BA4S08	7-27	34	470	1.3	387	17.0	42.0	1/2	M8
<b>QE6 SERIES — SÉRIE QE6 — BAUREIHE QE6 — SERIE QE6</b>									
QE6AC030FA2S06	6-24	30	1230	1.9	442	12.9	31.5	3/8	M8
QE6AC030FA4S08	6-24	30	1230	1.9	447	17.0	42.0	1/2	M8
QE6AC040FA4S06	8-32	40	910	1.9	447	17.0	42.0	3/8	M8
QE6AC040FA4S08	8-32	40	910	1.9	447	17.0	42.0	1/2	M8
QE6AC055FA5S08	11-44	55	650	1.9	453	21.5	44.7	1/2	M10
QE6AC080FA5S08	16-64	80	440	1.9	453	21.5	44.7	1/2	M10
<b>QE8 SERIES — SÉRIE QE8 — BAUREIHE QE8 — SERIE QE8</b>									
QE8AC065FA5S08	13-52	65	1200	2.9	516	21.5	44.7	1/2	M10
QE8AC070FA5S08	14-56	70	1100	2.9	516	21.5	44.7	1/2	M10
QE8AC090FA5S08	18-72	90	850	2.9	516	21.5	44.7	1/2	M10
QE8AC115FA6S08	23-92	115	660	2.9	520	24.3	50.0	1/2	M12
QE8AC150FA6S08	30-120	150	510	2.9	520	24.3	50.0	1/2	M12-M14
QE8AC225FA7S12	45-180	225	310	4.1	575	27.5	55.2	3/4	M16
QE8AC400FA8S12	80-320	400	170	6.0	635	33.3	68.5	3/4	M18

**QE4: 48.5 mm — QE6: 54.7 mm**  
**QE8: 61.1 mm**

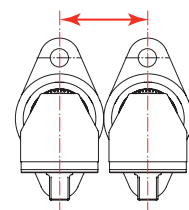

Electric Fixtured Wrenches  
Broches de vissage électriques  
Gesteuerte EC-Einbauspindeln  
Husillos de atornillado eléctricos  
Chiavi elettriche per installazioni fisse

QM  
Series



Standard  
Equipment

High duty cycle  
powerhead  
application

External  
electronics pod  
for a simpler  
integration and  
a better  
reliability

Highly  
configurable  
platform

Pour  
applications  
multi-broches  
en usage intensif

Carte  
électronique  
séparée pour  
intégration facile  
et fiable

Construction  
modulaire pour  
intégrations  
multiples

Für  
Mehrfachspindler  
mit höchsten  
Anforderungen

Externe  
Elektronik für  
einfache  
Integration und  
hohe Sicherheit

Modularer  
Aufbau für  
vielfache  
Integration

Para  
aplicaciones  
de multiples en  
uso intensivo

Carta  
electronica  
separada para  
integracion facil  
y fiable

Construcciones  
modulable para  
integraciones  
multiples

Applicazione  
multipli ad alta  
capacità

Connettore  
elettronico  
esterno per una  
più semplice  
integrazione e  
una maggiore  
affidabilità

Programmazione  
ad alto livello di  
configurazione

Standard equipment, applicable for all QM FIXTURED tools.

Equipements standard pour toutes les BROCHES DE VISSAGE QM.

Standardausrüstung bei allen QM-Einbauwerkzeugen.

Equipo estándar para aplicar a todas las herramientas QM no portátiles.

Equipaggiamento standard adatto per tutti i modelli installazione fissa serie QM.

QM3 Electric Spindles







Broches de vissage électriques droites QM3

QM3 gerade EC-Einbauspindeln

Husillos de atornillado eléctricos QM3

Chiavi elettriche diritte per installazioni fisse QM3

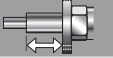
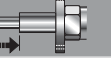
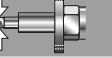

Ref.	 Nm	 Max. Nm	 rpm	 kg	 mm	 mm	 mm	 in	
<b>QM3 SERIES — SÉRIE QM3 — BAUREIHE QM3 — SERIE QM3</b>									
QM3SS008H62S06	2-6	8	1382	2.4	449	150	50	3/8	M4 - M5
QM3SS008H62S08	2-6	8	1382	2.4	449	150	50	1/2	M4 - M5
QM3SS008H92S06	2-6	8	1382	2.4	524	225	50	3/8	M4 - M5
QM3SS008H92S08	2-6	8	1382	2.5	524	225	50	1/2	M4 - M5
QM3SS008H22S06	2-6	8	1382	2.7	599	300	50	3/8	M4 - M5
QM3SS008H22S08	2-6	8	1382	2.7	599	300	50	1/2	M4 - M5
QM3SS012H62S06	3-10	12	927	2.4	449	150	50	3/8	M4 - M6
QM3SS012H62S08	3-10	12	927	2.4	449	150	50	1/2	M4 - M6
QM3SS012H92S06	3-10	12	927	2.5	524	225	50	3/8	M4 - M6
QM3SS012H92S08	3-10	12	927	2.5	524	225	50	1/2	M4 - M6
QM3SS012H22S06	3-10	12	927	2.7	599	300	50	3/8	M4 - M6
QM3SS012H22S08	3-10	12	927	2.7	599	300	50	1/2	M4 - M6
QM3SS016H62S06	4-13	16	686	2.4	449	150	50	3/8	M4 - M6
QM3SS016H62S08	4-13	16	686	2.4	449	150	50	1/2	M4 - M6
QM3SS016H92S06	4-13	16	686	2.5	524	225	50	3/8	M4 - M6
QM3SS016H92S08	4-13	16	686	2.5	524	225	50	1/2	M4 - M6
QM3SS016H22S06	4-13	16	686	2.7	599	300	50	3/8	M4 - M6
QM3SS016H22S08	4-13	16	686	2.7	599	300	50	1/2	M4 - M6
QM3SS020H62S06	5-16	20	545	2.4	449	150	50	3/8	M5 - M6
QM3SS020H62S08	5-16	20	545	2.4	449	150	50	1/2	M5 - M6
QM3SS020H92S06	5-16	20	545	2.5	524	225	50	3/8	M5 - M6
QM3SS020H92S08	5-16	20	545	2.4	524	225	50	1/2	M5 - M6
QM3SS020H22S06	5-16	20	545	2.7	599	300	50	3/8	M5 - M6
QM3SS020H22S08	5-16	20	545	2.7	599	300	50	1/2	M5 - M6

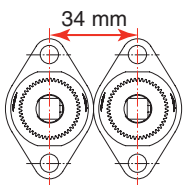











**QM  
Series**

**Electric Fixtured Wrenches**  
**Broches de vissage électriques**  
**Gesteuerte EC-Einbauspindeln**  
**Husillos de atornillado eléctricos**  
**Chiavi elettriche per installazioni fisse**

**QM5 & QM7 Electric Spindles**  
**Broches de vissage électriques droites QM5 ET QM7**  
**QM5 & QM7 gerade EC-Einbauspindeln**  
**Husillos de atornillado eléctricos QM5 Y QM7**  
**Chiavi elettriche diritte per installazioni fisse QM5 E QM7**



Ref.	 Nm	 Max. Nm	 1 min. rpm	 kg	 mm	 mm	 mm	 in	
<b>QM5 SERIES — SÉRIE QM5 — BAUREIHE QM5 — SERIE QM5</b>									
QM5SS035H62S06	9-28	35	590	3.9	523	150	50	3/8	M6 - M8
QM5SS035H62S08	9-28	35	590	3.9	523	150	50	1/2	M6 - M8
QM5SS035H92S06	9-28	35	590	4.0	598	225	50	3/8	M6 - M8
QM5SS035H92S08	9-28	35	590	4.0	598	225	50	1/2	M6 - M8
QM5SS035H22S06	9-28	35	590	4.2	673	300	50	3/8	M6 - M8
QM5SS035H22S08	9-28	35	590	4.2	673	300	50	1/2	M6 - M8
QM5SS055H62S06	14-44	55	507	3.9	523	150	50	3/8	M6 - M8
QM5SS055H62S08	14-44	55	507	3.9	523	150	50	1/2	M6 - M8
QM5SS055H92S06	14-44	55	507	4.0	598	225	50	3/8	M6 - M8
QM5SS055H92S08	14-44	55	507	4.0	598	225	50	1/2	M6 - M8
QM5SS055H22S06	14-44	55	507	4.2	673	300	50	3/8	M6 - M8
QM5SS055H22S08	14-44	55	507	4.2	673	300	50	1/2	M6 - M8
QM5SS090H62S08	23-72	90	280	3.9	523	150	50	1/2	M8 - M10
QM5SS090H92S08	23-72	90	280	4.0	598	225	50	1/2	M8 - M10
QM5SS090H22S08	23-72	90	280	4.2	673	300	50	1/2	M8 - M10
<b>QM7 SERIES — SÉRIE QM7 — BAUREIHE QM7 — SERIE QM7</b>									
QM7SS190H62S08	48-152	190	273	8.4	645	150	50	1/2	M10-M12
QM7SS190H62S12	48-152	190	273	8.4	645	150	50	3/4	M10-M12
QM7SS190H92S08	48-152	190	273	8.6	720	225	50	1/2	M10-M12
QM7SS190H92S12	48-152	190	273	8.6	720	225	50	3/4	M10-M12
QM7SS190H22S08	48-152	190	273	8.9	794	300	50	1/2	M10-M12
QM7SS190H22S12	48-152	190	273	8.9	794	300	50	3/4	M10-M12
QM7SS220H62S12	55-176	220	233	8.4	645	150	50	3/4	M10-M14
QM7SS220H92S12	55-176	220	233	8.6	720	225	50	3/4	M10-M14
QM7SS220H22S12	55-176	220	233	8.9	794	300	50	3/4	M10-M14

See accessories page 84.  
 Accessoires présentés page 84.  
 Zubehör finden Sie auf der Seite 84.  
 Ver la página 84 para los accesorios.  
 Vedere accessori a pagina 84.

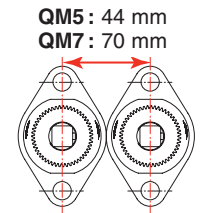

Electric Fixtured Wrenches  
 Broches de vissage électriques  
 Gesteuerte EC-Einbauspindeln  
 Husillos de atornillado eléctricos  
 Chiavi elettriche per installazioni fisse

QM  
 Series











**QM9 Electric Spindles**  
 Broches de vissage électriques droites **QM9**  
**QM9** gerade EC-Einbauspindeln  
 Husillos de atornillado eléctricos **QM9**  
 Chiavi elettriche diritte per installazioni fisse **QM9**



Fastening Control System for QM Series  
 Electric Tools, page 85.  
 Système d'asservissement pour les séries  
 électriques QE, page 85.  
 Schraubersteuerungen für Schrauber der QE  
 Serie, Seite 85.  
 Sistema de gestión de par para llaves  
 eléctricas QE, página 85.  
 Sistemi di gestione della coppia per chiavi  
 elettriche QE, pag 85.



QM9SS520H

Ref.	 Nm	 Max. Nm	 rpm	 kg	 mm	 mm	 mm	 in	
<b>QM9 SERIES — SÉRIE QM9 — BAUREIHE QM9 — SERIE QM9</b>									
QM9SS315H62S12	79-250	315	278	18.6	711	150	50	3/4	M10-M16
QM9SS315H62S16	79-250	315	278	18.7	711	150	50	1	M10-M16
QM9SS315H92S12	79-250	315	278	19.1	786	225	50	3/4	M10-M16
QM9SS315H92S16	79-250	315	278	19.2	786	225	50	1	M10-M16
QM9SS315H22S12	79-250	315	278	19.5	860	300	50	3/4	M10-M16
QM9SS315H22S16	79-250	315	278	19.6	860	300	50	1	M10-M16
QM9SS435H62S12	109-346	435	203	18.6	711	150	50	3/4	M12-M18
QM9SS435H62S16	109-346	435	203	18.7	711	150	50	1	M12-M18
QM9SS435H92S12	109-346	435	203	19.1	786	225	50	3/4	M12-M18
QM9SS435H92S16	109-346	435	203	19.2	786	225	50	1	M12-M18
QM9SS435H22S12	109-346	435	203	19.5	860	300	50	3/4	M12-M18
QM9SS435H22S16	109-346	435	203	19.6	860	300	50	1	M12-M18
QM9SS520H62S12	130-410	520	170	18.6	711	150	50	3/4	M12-M20
QM9SS520H62S16	130-410	520	170	18.7	711	150	50	1	M12-M20
QM9SS520H92S12	130-410	520	170	19.1	786	225	50	3/4	M12-M20
QM9SS520H92S16	130-410	520	170	19.2	786	225	50	1	M12-M20
QM9SS520H22S12	130-410	520	170	19.5	860	300	50	3/4	M12-M20
QM9SS520H22S16	130-410	520	170	19.6	860	300	50	1	M12-M20
QM9SS650H62S16	163-516	650	136	18.7	711	150	50	1	M14-M22
QM9SS650H92S16	163-516	650	136	19.6	786	225	50	1	M14-M22
QM9SS01KH62S16	250-800	1000	51	24.5	857	150	50	1	M16+
QM9SS15CH62S24	250-1300	1500	51	32.0	869	150	50	1 1/2	M16+
QM9SS18CH62S24	270-1500	1800	37	32.0	869	150	50	1 1/2	M16+
QM9SS20CH62S24	300-1700	2000	31	32.0	869	150	50	1 1/2	M16+
QM9SS22CH62S24	330-1900	2250	25	32.0	869	150	50	1 1/2	M16+

QM9: 89 mm  
 (QM9SS01KH62S16: 130 mm)

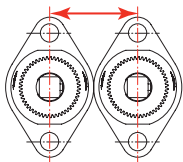



**QMM  
Series**

**Quick multiples up to 6 spindles**  
**Ensembles de vissage jusqu'à 6 broches**  
**Modulare Mehrfachsysteme bis zu 6 Spindeln**  
**Unidades múltiples de atornillado de hasta 6 husillos**  
**Multipli rapidi, fino a 6 mandrini**



*4-spindle horizontal/rotative DC fastening system*

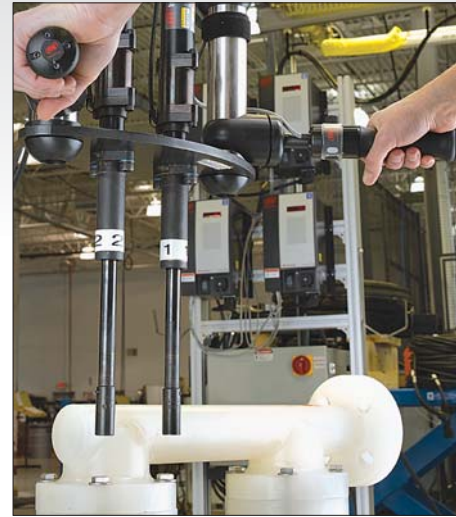

*2-spindle vertical DC fastening system*

Quick multiples consist of pre-engineered modular component designs that allow quick quoting, manufacture, and delivery of more common fixtured fastening solutions for up to six spindles. Depending on the application, vertical, horizontal, or rotating horizontal systems can be assembled with easily customized handles, displays, fixtures, and integrated handling devices for optimal operator ergonomics and performance.

Les ensembles multi-broche sont basés sur des composants modulaires qui permettent d'assembler et de fournir rapidement des équipements adaptés à la plupart des applications de vissage jusqu'à 6 broches. En fonction des applications, des ensembles multi-broches verticaux, horizontaux ou horizontaux/rotatifs peuvent être assemblés avec poignées de commande, fixation, tableaux de contrôle personnalisés et complétés si nécessaire de systèmes de manutention pour une parfaite ergonomie du poste de travail.

Das QMM-Baukastensystem für Mehrfachschräuber besteht aus genormten Bauelementen, die ein schnelles Angebot, Herstellung und Lieferung für gängige Mehrfachschräuber bis zu sechs Spindeln erlaubt. Je nach Anwendungsfall können die Systeme vertikal, horizontal oder drehend gelagert konfiguriert werden. Griffe, Anzeige und Spindeln können einfach und schnell nach Ihren Bedürfnissen konfiguriert werden.

Las unidades múltiples se basan en un diseño modular estándar que permite rebajar los tiempos de diseño, fabricación y entrega de las unidades de atornillado más habituales, con un máximo de 6 husillos por unidad. Dependiendo de la aplicación, se pueden montar sistemas verticales, horizontales o giratorios incluyendo mandos, displays, accesorios y dispositivos de manipulación integrados para un rendimiento y ergonomía óptimos.

L'unità multipla si basa su componenti modulari che permettono di assemblare e fornire rapidamente soluzioni multiple adatte alle più svariate applicazioni di avvitatura, fino ad un massimo di 6 avvitature multiple contemporaneamente. A seconda delle applicazioni richieste, avvitatura verticale, orizzontale o sistemi rotativi orizzontali, può essere assemblato con maniglie personalizzate, display, e se necessario, sistemi di movimentazione per garantire una perfetta ergonomia della postazione di lavoro.

**Quick multiples up to 6 spindles**  
**Ensembles de vissage jusqu'à 6 broches**  
**Modulare Mehrfachsysteme bis zu 6 Spindeln**  
**Unidades múltiples de atornillado de hasta 6 husillos**  
**Multipli rapidi, fino a 6 mandrini**



**Vertical fastening system**  
**Ensemble multibroche vertical**  
**Schraubsystem vertikal**  
**Sistema de atornillado vertical**  
**Sistema di fissaggio verticale**

Modular design provides for easy customization of open- or closed-frame fixtures in vertical, horizontal, or rotating horizontal configurations.

Mounts are available in several options that adjust to give operators the most ergonomic position, visibility, and control possible.

Handle module provides multiple switch options based on the application.

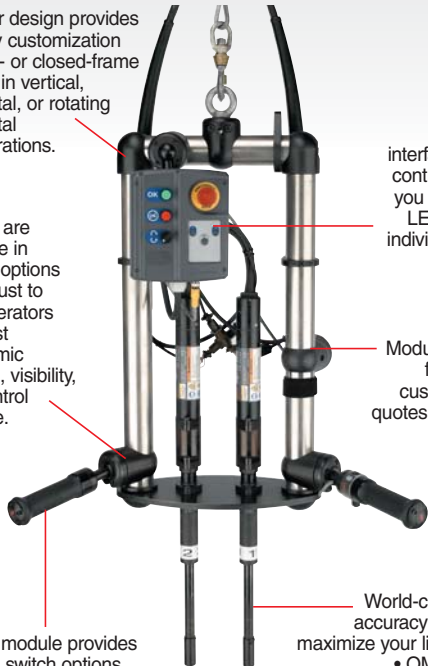

Customisable interface provides the control and feedback you desire. Standard LED display shows individual spindle and master OK/NOK signals.

Modular design offers flexibility for easy customization, rapid quotes, and lead-times.

World-class tools deliver accuracy and durability to maximize your line's productivity.

- QM and QE Series
- QA4, 6, 8 Series.

**Horizontal fastening system**  
**Ensemble multibroche horizontal**  
**Schraubsystem horizontal**  
**Sistema de atornillado horizontal**  
**Sistema di fissaggio orizzontale**

Multiple suspension and torque reaction options:

- Balancers
- Torque tubes
- Articulating arms
- Custom devices
- Jib cranes
- Pneumatic suspension

Cable tray provides secure routing path, which keeps cables safe and out of the way, and reduces sharp bends.

Circular handle allows rapid positioning of sockets on bolts.

Mounting plates can be quickly and easily machined to the exact job specifications.

Heavy-duty bearing delivers smooth rotation and adjustable stops for up to six spindles and provides for an ideal cable exit.

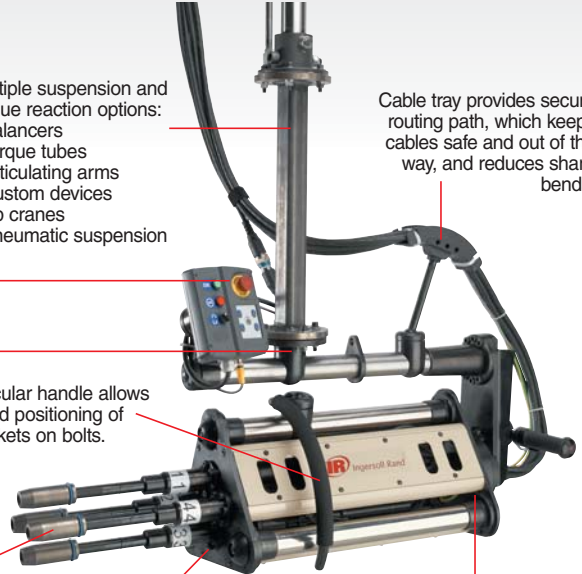

**Interface Module**



Standard module includes:

- Enclosure and PCB
- E-Stop, whip cable
- LED display, label kit

Standard E-stop.

Additional options include:

- Push button
- 2-position switch
- 3-position switch
- 3-position key switch
- Red and green lamps
- Buzzer

Standard LED display shows individual and master OK / NOK signal for up to six spindles, and can be organized to match bolt pattern.

**Handle Module**



Slide switch can be configured as momentary or detent style.

20 possible configurations deliver the exact combination needed.

Trigger and slide switch can be aligned (shown left) or rotated 90 degrees (shown above) based on desired hand positioning.

Ball, flange, or direct mounting options allow optimal handle orientation with the operator.

Ergonomic grip provides both comfort and durability.

Actuation options include:

- Trigger, slide switch, both
- Pneumatic
- Dead handle (none)

Please contact our Solutions Center for further information on these customisable products.

Contacter notre Centre d'Applications pour de plus amples informations sur ces équipements personnalisables.

Nehmen Sie bitte mit unserem Solutions Center Kontakt für weitere Informationen zu erhalten.

Contacte con nuestro Centro de Soluciones para más información de estos sistemas personalizables.

Perfavore contattate il nostro Solutions Center per ulteriori informazioni su questi prodotti personalizzabili.



**Ingersoll Rand**  
**Solutions Center**  
**70, rue Jacquard**  
**77400 Lagny sur Marne**  
**France**

Tel: +33 1 64 76 00 00

E-mail:  
 Solutions\_Center@eu.irco.com

Power cables (QE & QM)  
 Câbles d'alimentation (QE & QM)  
 Stromkabel (QE & QM)  
 Cables eléctricos (QE & QM)  
 Cavi di alimentazione (QE & QM)



GEA40-CORD-3M-90

Standard tool cable	L = 3 m:	GEA40-CORD-3M
Câble d'alimentation standard	L = 6 m:	GEA40-CORD-6M
Standard-Werkzeugkabel	L = 10 m:	GEA40-CORD-10M
Cable de herramienta estándar		
Cavo di alimentazione standard		
Standard 90° cable (90° on side tool)	L = 3 m:	GEA40-CORD-3M-90
Câble d'alimentation 90° côté outil	L = 6 m:	GEA40-CORD-6M-90
Standard-Werkzeugkabel 90°	L = 10 m:	GEA40-CORD-10M-90
Cable de herramienta estándar 90°		
Cavo di alimentazione standard 90°		
Flexible power cable	L = 3 m:	CPS2-CORD-3M
Câble d'alimentation souple	L = 6 m:	CPS2-CORD-6M
Flexible Stromkabel	L = 10 m:	CPS2-CORD-10M
Cable de herramienta flexible	L = 13 m:	CPS2-CORD-13M
Cavo di alimentazione flessibile	L = 15 m:	CPS2-CORD-15M
	L = 6 m / 90°:	CPS2-CORD-6M-90
Extension cable		
Rallonge	L = 10 m:	GEA40-EXT-10M
Verlängerung	L = 20 m:	GEA40-EXT-20M
Prolongación	L = 40 m:	GEA40-EXT-40M
Prolunghe		



QE2PT010PMO

QE2SP005PMO



QE2 Motors  
 Moteurs QE2  
 QE2 Motoren  
 Motores QE2  
 Motori QE2

Tools are supplied with no front end attachment, so that customized heads (including screwfeed attachments) can easily be assembled to the tool. To order a QE2 motor use the same model number as for the standard pistol and inline tool, but replace the last five digits with "MO" (e.g. QE2PS007PMO).

Outils livrés sans équipement frontal afin que des têtes personnalisées, y compris des systèmes d'alimentation de vis, puissent être montés sur les outils. Pour commander un moteur QE2, utiliser le même no. de modèle que pour les visseuses droites et pistolets standards, et remplacer les 5 derniers chiffres par "MO" (exemple, QE2PS007PMO).

Das Werkzeug wird ohne Abtrieb geliefert, so dass Spezialköpfe angebracht werden können, wie z. B. Klingen für Schraubenzuführungen. Um einen QE2 Motor zu bestellen, verwenden Sie die gleiche Model-Nr. wie für die Standard-Pistolenbauform oder gerade Bauform und ersetzen Sie die letzten 5 Kennziffern mit "MO" (z.B. QE2PS007PMO).

Herramientas suministradas sin eje de accionamiento, por lo que se facilita la posibilidad de adaptar cabezas especiales, incluyendo accesorio para alimentación de tornillos. Para pedir un motor QE2, utilice el mismo número de modelo que el estándar de pistola ó recto y reemplace los últimos 5 dígitos por "MO" (ej. QE2PS007PMO)

L'utensile viene fornito senza unità di testa, in modo che si possano montare teste speciali, compresi sistemi di alimentazione viti, può essere facilmente montato nella parte anteriore dello strumento. Per ordinare un motore QE2, utilizzare lo stesso numero di modello. Per utensili standard a pistola e in linea sostituire le ultime 5 cifre con "MO" (esempio QE2PS007PMO).

Accessories for QE Screwdrivers  
 Accessoires pour Visseuses QE  
 Zubehör für QE-Schrauber  
 Accesorios para Atornilladores QE  
 Accessori per Cacciaviti QE



GEA4-K48



GEM120-K48



GEA40-K364



GEA15-K48



7L-365



GEA40-K98EL

Square mounting plate (1) Plaque de montage cannelée (1) Verzahnte Montageplatte (1) Soporte de montaje estriada (1) Piastra di montaggio scanalata (1)	QE4 Series:	GEA4-K48
	QE6 & QE8:	DAM120-K48
Flanged mounting plate (1) Bride de montage cannelée (1) Flanschbefestigung (1) Brida de soporte estriada (1) Flangia di montaggio scanalata (1)	QE4 Series:	15EA-K48
	QE6 & QE8:	GEM120-K48
Short lever kit Lever de cde. court Kurzer Starthebel Kit de palanca corta Kit leva corta	QE4, QE6 & QE8:	GEA40-M98SL
Extended lever kit Lever de cde. long Verlängerungshebel Palanca prolongada Leva prolungata	QE4, QE6 & QE8:	GEA40-K98EL
Reaction bar kit (1) Barre anti-réaction (1) Reaktionsstab (1) Kit de barra de reacción (1) Kit barra di reazione (1)	QE4 Series:	GEA15-K48
	QE4TS Series:	GEPTS15-K48
	QE6 & QE8:	DEA120-K48
Swivel hanger Anse de suspension rotative Drehbare Aufhängevorrichtung Soporte de suspensión giratorio Anello di sospensione girevole	QE2 Series:	CPS2-A365
	QE4 Series:	GEA15-K364
	QE6 & QE8:	GEA40-K364
Suspension bail Anneau de suspension Aufhänger Gancho de suspensión Dispositivo di sospensione	QE2, QE4 QE6, QE8:	7L-365

(1) Require short coupling nut, ref. DAA4-27

(1) Necessite l'ajout d'un écrou court, réf. DAA4-27

(1) Erfordert kurze Überwurfmutter DAA4-27

(1) Necessita tuerca de conexión corta DAA4-27

(1) Richiede dado corto DAA4-27

**Fastening Control System for QE & QM Series Electric Tools**  
**Système d'Asservissement pour les Séries Electriques QE et QM**  
**Schraubersteuerungen für Schrauber der QE/QM- Serie**  
**Systema de Gestión de Par para Llaves Eléctricas QE y QM**  
**Sistemi di Gestione della Coppia per Chiavi Elettriche QE e QM**

**DC  
Control**



Standard Ethernet and I/O connections optimize communication and line integration.

Les ports Ethernet et E/S standard optimisent la communication et l'intégration sur ligne.

Standardmäßig vorhandene-Ethernet und E/A-Anschlüsse optimieren die Kommunikation und die Integration in Ihre Montagelinien.

Conexión estándar Ethernet y E/S optimizan la comunicación y la integración de la línea.

Conessioni standard Ethernet ed I/O ottimizzano la comunicazione e l'integrazione della linea.

Program up to eight basic fastening configurations and access all 256 stored in memory.

Programmez jusqu'à 8 configurations de vissage de base et accédez aux 256 configurations enregistrées dans la mémoire.

Programmierung von bis zu acht verschiedenen Schraubprogrammen plus Zugriff auf alle 256 im Speicher.

Programa hasta ocho configuraciones de base de puesta en marcha y acceso a todas las 256 en memoria.

Programma fino ad otto configurazioni base di avvitatura ed ha accesso a tutte le 256 in memoria.

Removable cover provides easy access to connections and terminals.

Le couvercle amovible permet un accès aisé aux ports et aux bornes.

Ein abnehmbarer Deckel ermöglicht einen leichten Zugriff auf Anschlüsse und Klemmen.

Protección extraíble permitiendo un fácil acceso a las conexiones y a los terminales.

Protezione rimovibile permette facile accesso alle connessioni ed ai terminali.

Parameter Transfer Key (PTK) enables quick upload, recovery, transfer, and storage of configuration sets.

La touche de transfert des paramètres (PTK) permet le chargement, la récupération, le transfert et l'enregistrement rapides des configurations.

Parameter-Transfer-Stick (PTK) ermöglicht schnelles Hochladen, Wiederherstellen, Übertragen und Speichern von Konfigurationssätzen.

Parameter transfer key (PTK) permite un veloz UPLOAD, restablecimiento, transferencia y memorización del set de configuración.

Parameter Transfer Key (PTK) permette veloce up load, ripristino, trasferimento e memorizzazione di set di configurazione.

Professional 1/4 VGA 216-color display is visible from 20 ft (6.1 m).

L'écran professionnel 1/4 VGA à 216 couleurs est visible jusqu'à 6 m.

Das professionelle 1/4 VGA 216-Farbdisplay ist aus einer Entfernung von 6 m klar zu erkennen.

Pantalla profesional VGA 216 colores visibles de 6 m.

Display professionale 1/4 VGA 216 colori, visibile da 6 m.

The controller has 1,000 cycles of end-of-run automatic data storage.

Enregistrement auto. des données de 1000 cycles en fin de course.

Die Steuerung verfügt über einen automatischen Datenspeicher der letzten 1000 Zyklusdatensätze.

El controlador tiene 1000 ciclos de memoria automática de datos, al final de la ejecución.

L'unità di controllo dispone di 1000 cicli di memorizzazione automatica dati di fine esecuzione

Dual-mode power supply: 90 – 120 VAC and 200 – 240 VAC.

Alimentation électrique double : 90 – 120 VAC et 200 – 240 VAC.

Duale Stromversorgung: 90 – 120 V Wechselspannung und 200 – 240 V Wechselspannung.

Doble modalidad de alimentación 90-120 VAC 200-240 VCA.

Doppia modalità di alimentazione: 90-120 VAC e 200-240 VCA.

Internal maximum ambient operating temperatures of 0 – 50° C ensure reliable use in demanding conditions without risk of overheating.

La température de fonctionnement interne de 0° à 50° garantit une utilisation fiable dans des conditions exigeantes, sans risque de surchauffe.

Interne max. Betriebstemperaturen von 0° – 50° C gewährleisten einen zuverlässigen Einsatz unter erschwerten Bedingungen ohne die Gefahr einer Überhitzung.

Temperatura ambientale interna massima de 0°- 50°C aseguran un uso fiable en condiciones difíciles sin riesgos de recalentamiento.

Temperature ambientali interne di operatività massime di 0°-50°C (32°-122° F) assicurano un uso affidabile in condizioni difficili senza rischi di surriscaldamento.

Easy installation and set-up with convenient bracketing system.

Installation simple grâce au système de fixation incorporé.

Einfache Installation und Einrichtung mit komfortablem Halterungssystem.

Fácil instalación con práctico sistema de soporte.

Facile installazione con pratico sistema di supporto.



**Insignia  
Display  
IC12D**

One-line digital display shows torque or angle.

Un affichage numérique 1 ligne indiquant le couple ou l'angle.

Einzeilige digitale Anzeige zeigt Drehmoment oder Winkel an.

Pantalla digital de una línea os muestra el par o el ángulo.

Display digitale one-line mostra la coppia o l'angolo.

200 cycles of end-of-run automatic data storage.

Enregistrement auto. des données de 200 cycles en fin de course.

Automatischer Datenspeicher der letzten 200 Schraubdatensätze

Memorización auto. de datos de 200 ciclos al final de la ejecución

Memorizzazione automatica dati di 200 cicli fine esecuzione.

Use ICS Connect to program and select from 256 basic configurations stored in memory.

Utilisez ICS Connect pour programmer et faire votre choix parmi les 256 configurations enregistrées dans la mémoire.

Programmierung und Auswahl aus 256 im Speicher abgelegten einfachen Konfigurationen über ICS Connect.

Usar ICS Connect para programar y seleccionar entre 256 configuraciones de base memorizadas.

Usate ICS Connect per programmare e selezionare tra 256 configurazioni base memorizzate.



**Insignia Module IC1M**

10



**DC  
Control**

**Fastening Control System for QE & QM Series Electric Tools**  
**Système d'Asservissement pour les Séries Electriques QE et QM**  
**Schraubersteuerungen für Schrauber der QE/QM- Serie**  
**Systema de Gestión de Par para Llaves Eléctricas QE y QM**  
**Sistemi di Gestione della Coppia per Chiavi Elettriche QE e QM**

## Insight IC12 Display & IC12Module

Model identification codes  
 Codification des références  
 Modellnummern-Code  
 Códigos de identificación  
 Codici identificazione modello

Example:  
 Exemple:  
 Beispiel:  
 Ejemplo:  
 Esempio:

**IC12D3A1AWS**

Insight  
Display  
IC12D



Insight  
Module  
IC12M



Insight Product Definition	Configuration Insight	Optionen für Insight	Configuración Insight	Configurazioni Insight
<b>Model</b> IC = INSIGHT Controller	<b>Modèle</b> IC = INSIGHT Controller	<b>Modell</b> IC = INSIGHT Controller	<b>Modelo</b> IC = INSIGHT Controller	<b>Modello</b> IC = INSIGHT Controller
<b>Number of Tools or Spindles</b> 12 = one tool/spindle	<b>Nombre d'outils ou de broches</b> 12 = Un outil/broche	<b>Anzahl der Werkzeuge oder Spindeln</b> 12 = 1 Werkzeug/1 Spindel	<b>Número de herramientas o husillos</b> 12 = 1 herramienta /husillo	<b>Numero di utensili e/o mandrini</b> 12 = un utensile/mandrino
<b>User interface</b> D = DISPLAY, with user interface M = MODULE, without user interface	<b>Interface utilisateur</b> D = DISPLAY, avec interface utilisateur M = MODULE, sans interface utilisateur	<b>Anzeigesystem</b> D = DISPLAY, mit Anwender Schnittstelle M = MODULE, ohne Anwender Schnittstelle	<b>Paquete de luces</b> D = DISPLAY, con interfaz utilizador M = MODULE, sin interfaz utilizador	<b>Indicatori luminosi</b> D = DISPLAY, con interfaccia utilizzatore M = MODULE, senza interfaccia utilizzatore
<b>Power Supply</b> 1 = 115 VAC, US plug 2 = 220 V, US cable pigtail 3 = 230 VAC, cable pigtail, european standard	<b>Alimentation électrique</b> 1 = 115 V, prise USA 2 = 220 V, câble nu USA 3 = 230 VAC, câble nu, norme européenne	<b>Netzteil</b> 1 = 115 V, US-Stecker 2 = 220 V, US (ohne Stecker) 3 = 230 V Kabel ohne Stecker (Europastandard)	<b>Alimentación eléctrica</b> 1 = 115 V, USA 2 = 220 V, USA cable solo 3 = 230 V - cable solo - estándar europeo	<b>Alimentazione elettrica</b> 1 = 115 V, USA 2 = 220 V, USA cavo b.t. 3 = 230 VCA a norme europee
Optional equipment	Equipements en option	Zonderzubehör	Equipo opcional	Equipaggiamento a richiesta
<b>I/O (input &amp; output options)</b> A = Standard I/O interface board B = One additional I/O board for single spindle	<b>I/O (options d'entrée et de sortie)</b> A = Interface standard B = Une carte additionnelle pour système multifonctions à une broche	<b>E/A-Optionen</b> A = Standard-Eingänge/Ausgänge B = Eine zusätzliche Leiterplatte (Mindestanforderung für 2-Spindel-Regler)	<b>I/O (opciones de entrada y salida)</b> A = Interface estándar para unidad básica B = Una tarjeta adicional para sistema multifunción a un husillo	<b>I/O (input &amp; output opzioni)</b> A = Interfaccia standard B = Una scheda addizionale per sistema multifunzione a un mandrino
<b>Communication Package</b> 1 = Serial and Ethernet 3 = Option 1 + Profibus 4 = Option 1 + Devicenet 5 = Option 1 + Interbus-S 6 = Option 1 + EtherNet/IP, Modbus-TCP	<b>Kit de communication</b> 1 = Série et Ethernet 3 = Option 1 + Profibus 4 = Option 1 + Devicenet 5 = Option 1 + Interbus-S 6 = Option 1 + EtherNet/IP, Modbus-TCP	<b>Kommunikationssystem</b> 1 = Seriell und Ethernet 3 = Option 1 + Profibus 4 = Option 1 + Devicenet 5 = Option 1 + Interbus-S 6 = Option 1 + EtherNet/IP, Modbus-TCP	<b>Paquete de comunicación</b> 1 = Ethernet y paralelo 3 = Opción 1 + Profibus 4 = Opción 1 + Devicenet 5 = Opción 1 + Interbus-S 6 = Opción 1 + EtherNet/IP, Modbus-TCP	<b>Kit di comunicazione</b> 1 = Seriale e Ethernet 3 = Opzione 1 + Profibus 4 = Opzione 1 + Devicenet 5 = Opzione 1 + Interbus-S 6 = Option 1 + EtherNet/IP, Modbus-TCP
<b>Parameter Transfer Key</b> A = Standard (no key) B = Parameter transfer key included	<b>Clé de transfert des paramètres</b> A = Standard (sans clé) B = Clé de transfert incluse	<b>Parameter Übernahme Stick</b> A = Standard (kein Stick) B = Mit Parameter Übernahme Stick	<b>Llave de transferencia de parámetros</b> A = Standard (sin llave) B = Llave de transferencia incluido	<b>Chiave trasferimento parametri</b> A = Standard, senza chiave B = Chiave inclusa
<b>Mounting Style</b> W = Standard wall mount C = Cabinet mount	<b>Type de montage</b> W = Montage mural C = Montage en cabine	<b>Befestigung</b> W = Standard-Wandträger C = Schrankträger	<b>Tipo de montaje</b> W = Montaje estándar a pared C = Montaje en pieza	<b>Tipo de montaggio</b> W = Montaggio standard a muro C = Montaggio in armadio
<b>Software Package</b> S = Standard XX = Customised software	<b>Programmes</b> S = Standard XX = Programme personnalisé	<b>Softwarepaket</b> S = Standard XX = Kundenspezifische Lösung	<b>Paquete software</b> S = Estándar XX = Programa personalizado	<b>Pacchetto software</b> S = Standard XX = Pacchetto personalizzato

**Fastening Control System for QE & QM Series Electric Tools**  
**Système d'Asservissement pour les Séries Electriques QE et QM**  
**Schraubersteuerungen für Schrauber der QE/QM- Serie**  
**Systema de Gestión de Par para Llaves Eléctricas QE y QM**  
**Sistemi di Gestione della Coppia per Chiavi Elettriche QE e QM**

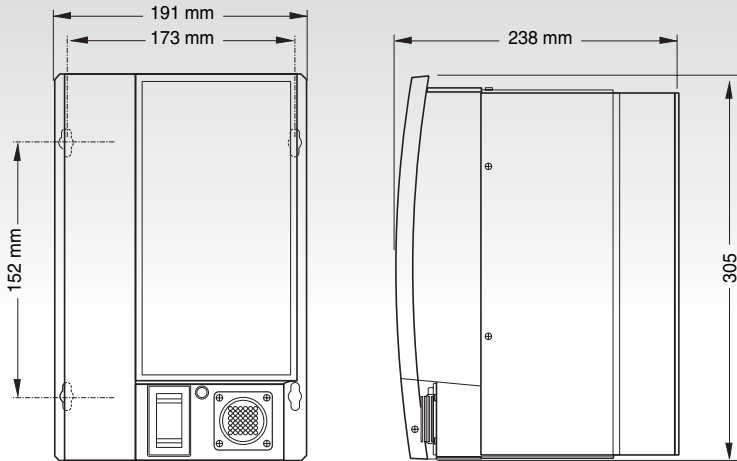

## Insight IC12 Display & IC12 Module

<b>Measurement accuracy</b>	Torque : $\pm 0.2\%$ of torque full scale $\pm 1$ count of angle (degrees)
<b>Measurement resolution</b>	$\pm 0.025\%$ of torque full scale
<b>Torque transducer bridge excitation</b>	$\pm 5\text{VDC/GND}$
<b>Torque transducer zero offset/drift compensation</b>	$\pm 0.4\%$ of full scale
<b>Input Signal Sensitivity</b>	2.0 mV/V
<b>Calibration</b>	Values read from spindle memory Automatic digital correction
<b>Frequency response (torque filter)</b>	Selectable 75 Hz, 150 Hz, 350 Hz, 500 Hz, 750 Hz
<b>Keypad (IC-D only)</b>	Membrane keypad containing four hot keys, four function keys, numerical keypad and directional keypad
<b>Display</b>	IC-D--3.5-inch diagonal, 320px by 240px, 8-bit 65K backlit color (QVGA) flat panel display. IC-M--5- character, 7-segment numerical LED display.
<b>Parameter sets</b>	256
<b>Number of cycles stored in memory</b>	IC-D: 1,000. IC-M: 200.
<b>Statistics Data Memory</b>	100,000 per spindle
<b>Communications</b>	Serial RS232, Ethernet, USB, Optional Profibus or DeviceNet.
<b>I/O</b>	8 inputs/8 outputs, with behavior assignable through ISC software. With optional I/O card, an additional 16 inputs and outputs are available.
<b>Indicators</b>	Power ON lamp
<b>Optional devices</b>	DeviceNet Card, Profibus Card, Additional I/O, Cabinet Mounting Bracket.
<b>Input voltage</b>	Single Phase 120 Volts, 50/60 Hz, 16 Amps Single Phase 230 Volts, 50/60 Hz, 8 Amps
<b>Ambient operating conditions</b>	0-50° C, 20/90% non-condensing humidity
<b>Enclosure</b>	IP-52
<b>System Weight</b>	5.6 kg (12.4 pounds)

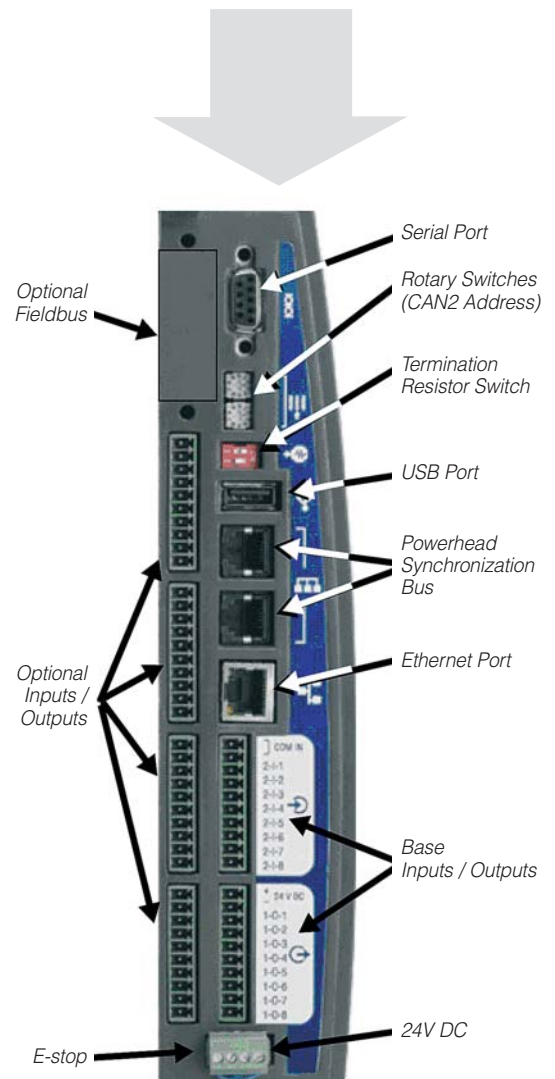

10



**DC  
Control**

**Fastening Control System for QE & QM Series Electric Tools**  
**Système d'Asservissement pour les Séries Electriques QE et QM**  
**Schraubersteuerungen für Schrauber der QE/QM- Serie**  
**Systema de Gestión de Par para Llaves Eléctricas QE y QM**  
**Sistemi di Gestione della Coppia per Chiavi Elettriche QE e QM**



Paired with an Insight IC12D or IC12M controller and a PC computer, our groundbreaking ICS Software Suite makes it possible to more precisely control and monitor your fastening process.

Associé à un contrôleur Insight IC12D ou IC12M et installé sur un ordinateur PC, le logiciel ICS permet une gestion complète de votre processus de vissage. Il combine une simplicité de programmation à des solutions de traçabilité et de contrôle de la Qualité de premier ordre.

Zusammen mit einer Insight-Steuerung IC12D oder IC12M und einem PC Computer ermöglicht es unsere bahnbrechende ICS-Softwarereihe Ihren Verschraubungsvorgang präziser zu steuern und zu überwachen. Das Optimieren Ihres Systems ist genau so einfach wie das Auswählen eines der vier Pakete.

Junto a una unidad de control Insight IC12D o IC12M y a un ordenador PC, software ICS es absolutamente nuevo en su tipología, permite de controlar y guiar con más precisión vuestro proceso de puesta en marcha.

Abbinato ad un'unità di controllo Insight IC12D o IC12M ed ad un computer PC, Software Suite ICS, assolutamente innovativo nel suo genere, permette di controllare e monitorare più precisamente il Vostro processo di avvitatura.

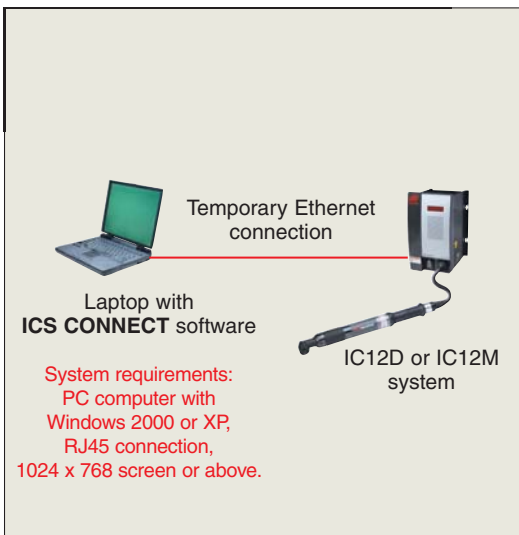

### ICS Connect

ICS Connect provides operators the ability to access and program basic fastening strategies, as well as view cycle data with a single IC12D or IC12M controller via a one-to-one Ethernet connection. ICS Connect is supplied standard with all IC12D and IC12M controllers.

ICS Connect permet aux opérateurs de programmer et d'accéder à des stratégies de vissage de base ainsi que de consulter les données de cycle avec un contrôleur IC12D ou IC12M via une connexion Ethernet de type 1:1. ICS Connect est fourni en standard avec tous les contrôleurs.

ICS Connect ermöglicht es dem Bediener, auf einfache Verschraubungsstrategien zuzugreifen und diese zu programmieren sowie Zyklusdaten über eine IC12D oder IC12M Einkanalsteuerung via direktem Ethernet-Anschluss anzuzeigen. ICS Connect wird standardmäßig mit allen IC12D- und IC12M-Steuerungen geliefert.

ICS Connect abastece a los operadores la habilidad de acceso y de programar, estrategias de fijación base, como también de controlar datos de ciclo con una unidad de control única IC12D o IC12M conectada directamente a través de Ethernet. ICS Connect lo abastecemos estándar con todas las unidades de control IC12D y IC12M.

ICS Connect fornisce agli operatori l'abilità di accedere a, e di programmare, strategie base di avvitatura, come pure di visionare dati di ciclo con un' unità di controllo singola IC12D o IC12M connessa direttamente via Ethernet. ICS Connect viene fornito standard con tutte le unità di controllo IC12D e IC12M.

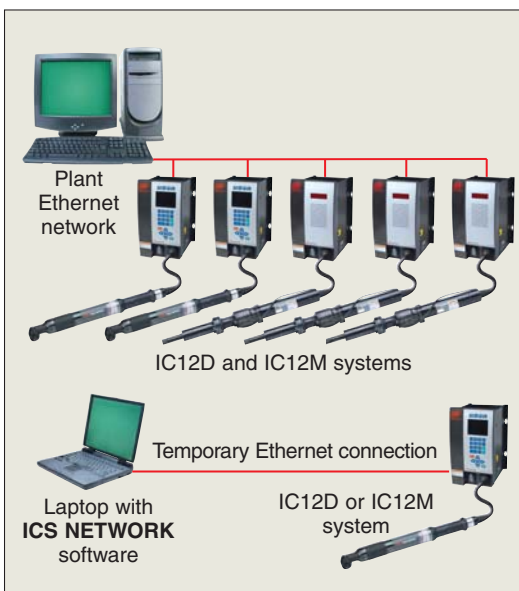

### ICS Network

ICS Network enables programming of multiple IC12D and IC12M controllers connected through a local area network (LAN) or direct connection. This option also allows operators to program advanced fastening strategies including yield and prevailing torque control.

ICS Network permet la programmation de plusieurs contrôleurs IC12D et IC12M raccordés par un LAN ou une connexion directe. Cette option permet également aux opérateurs de programmer des stratégies de vissage avancées y compris le vissage à la limite élastique et le couple de traînée pour écrou frein.

ICS Network ermöglicht die Programmierung mehrerer IC12D- und IC12M-Steuerungen über ein lokales Datennetz (LAN) oder über einen Direktanschluss. Diese Option ermöglicht es dem Bediener außerdem, moderne Verschraubungsstrategien einschließlich Streckgrenze und Selbstschneidedrehmoment zu programmieren.

ICS Network permite la programación de unidad de control múltiple IC12D y IC12M conectadas con una red local (LAN) o con conexión directa. Esta opción permite además al operador de programar estrategias de puesta en marcha que incluyan el control de "enervation" y de par dominante.

ICS Network permette la programmazione di unità di controllo multiple IC12D e IC12M connessa con una rete locale (LAN) o a connessione diretta. Questa opzione permette inoltre all'operatore di programmare strategie avanzate di avvitatura comprendenti il controllo di snervamento e di coppia dominante.



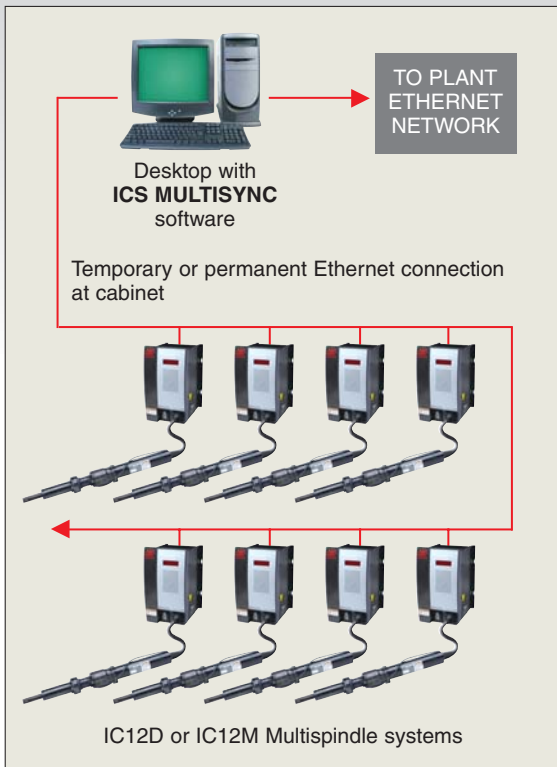

### ICS MultiSync

The ICS MultiSync package facilitates set-up and control of multispindle systems consisting of up to 100 spindles in groups of up to 40 spindles. This package also offers advanced multispindle fastening strategies, remote monitoring, and data archiving.

Le progiciel MultiSync facilite le paramétrage et le contrôle des systèmes à broches multiples (jusqu'à 100) par groupes pouvant atteindre 40 broches. Ce progiciel permet également des stratégies de vissage avancées à plusieurs broches, le contrôle à distance et l'archivage des données.

Das ICS-MultiSync-Paket ermöglicht die Einrichtung und Steuerung von Mehrfachspindelsystemen, die aus bis zu 100 Spindeln bestehen, die in Gruppen von bis zu 40 Spindeln synchronisiert arbeiten. Dieses Paket enthält außerdem moderne Mehrfachspindel-Verschraubungsstrategien, eine ferngesteuerte Überwachung und eine Datenarchivierung.

El paquete ICS MultiSync facilita la configuración y el control de sistemas multihusillos donde encontramos hasta 100 husillos divididos en grupos de un máximo de 40 husillos. Este paquete ofrece además estrategias de puesta en marcha multihusillo avanzada, control a distancia y archivo de datos.

Il pacchetto ICS MultiSync facilita il set-up ed il controllo di sistemi multimandrino comprendenti fino a 100 mandrini suddivisi in gruppi di al massimo 40 mandrini. Questo pacchetto offre inoltre strategie di avvitatura multimandrino avanzate, monitoraggio a distanza ed archiviazione dati.

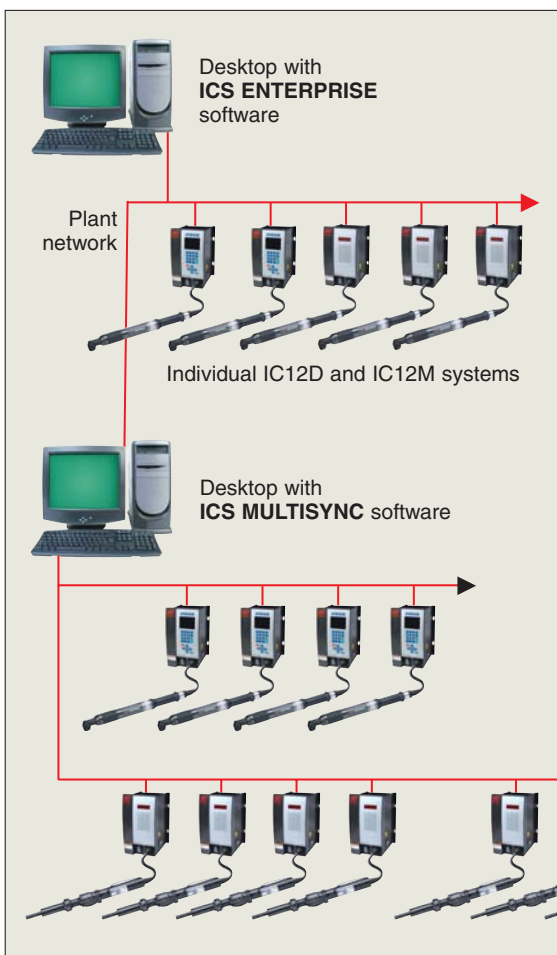

### ICS Enterprise

ICS Enterprise offers advanced programming and management of a network of up to 500 IC12D or IC12M controllers using QE tools, QM spindles, or multispindle systems. Also enables ODBC-compliant database archiving, searching, and statistics processing.

ICS Enterprise permet la programmation et la gestion avancées d'un réseau pouvant comporter jusqu'à 500 contrôleurs IC12D ou IC12M utilisant des outils QE, des broches QM ou des systèmes à broches multiples. Permet également l'archivage de bases de données compatibles ODBC, la recherche et la réalisation de statistiques.

ICS Enterprise bietet eine moderne Programmierung und eine moderne Netzwerk-Verwaltung von bis zu 500 IC12D oder IC12M Steuerungen, die QE Werkzeuge, QM Spindeln oder Mehrfachspindelsysteme verwenden. Außerdem ermöglicht ICS Enterprise eine ODBC-kompatible Datenbankarchivierung, Datenorganisation und Statistikverarbeitung.

ICS Enterprise ofrece la programación avanzada y la gestión de una red compuesta de un máximo de 500 unidades de control IC12D o IC12M que trabajan con herramientas QE, husillos QM o sistemas multihusillo. Además permite el archivo de base de datos compatibles ODBC, la investigación y la elaboración estadística.

ICS Enterprise offre la programmazione avanzata e la gestione di una rete composta da un massimo di 500 unità di controllo IC12D o IC12M che operino con utensili QE, mandrini QM, o sistemi multimandrino. Inoltre permette l'archiviazione di database compatibile ODBC, la ricerca e l'elaborazione di statistiche.

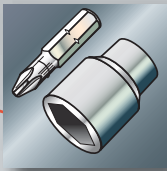

**DC  
Control**

**Fastening Control System for QE & QM Series Electric Tools**  
**Système d'Asservissement pour les Séries Electriques QE et QM**  
**Schraubersteuerungen für Schrauber der QE/QM- Serie**  
**Systema de Gestión de Par para Llaves Eléctricas QE y QM**  
**Sistemi di Gestione della Coppia per Chiavi Elettriche QE e QM**

**Insight software feature matrix**

	<b>Insight IC12M</b>	<b>Insight IC12D</b>	<b>Via ICS Connect</b>	<b>Via ICS Network</b>	<b>Via ICS MultiSync</b>	<b>Via ICS Enterprise</b>
<b>Software Programming</b>						
Max Number of Configs	256	256	Unlimited	Unlimited	Unlimited	Unlimited
Max Number of Steps	32 per config.	32 per config	1	32 per config	32 per config	32 per config
Prog. Params. Editable		●	●	●	●	●
Gang count		●	●	●	●	●
Autoincrement		●	●	●	●	●
Quick Setup		●	●	●	●	●
Advanced Setup			●	●	●	●
Config Name		Display only	●	●	●	●
CW/CCW Tightening		●	●	●	●	●
Tubenut Operation		●	●	●	●	●
Adjustable Acceleration				●	●	●
Optional EOR for each Step				●	●	●
Synchronizing Spindles					●	●
Copy protection			●	●	●	●
<b>Data Archiving</b>						
No. of stored EOR Records	200	1000	Unlimited (manual)	Unlimited (manual)	Unlimited (auto.)	Unlimited (auto.)
Databases data can be transferred to					ODBC	ODBC
Backup data to server					●	●
<b>Powerhead</b>						
Powerhead Operation					●	●
Max No. of Spindles in Powerhead					40	40
Max No. of Groups					8	8
Fault Backout					●	●
Fault Backout Options					None, spindle, group, powerhead	
Final Fault Backout					●	●
Final Fault Backout Options					None, spindle, group, powerhead	
Synchronization Method					Via CANBUS	
<b>Software General</b>						
Date/Time Set		●	●	●	●	●
System Name			●	●	●	●
Display Software versions		●	●	●	●	●
Language Selection		●	Only ICS Language	Only ICS Language	Only ICS Language	Only ICS Language
NTP Function		●	●	●	●	●
E.O.R. Onscreen filter			●	●	●	●
E.O.R. viewable onscreen	Primary value only	●	●	●	●	●
Load New Software via Ethernet	●	●	●	●	●	●
<b>Tool Programming</b>						
TR Adjust		●	●	●	●	●
ASC Adjust		●	●	●	●	●
TR and ASC Reset		●			●	●
Auto Calibration Function			X with ETA	X with ETA direct connect only		
Torque Units Selection		●	●	●	●	●
Start Mode Selection		●	●	●	●	●
Tool Operation Selection		●	●	●	●	●
Special Fn Switch Programming		●	●	●	●	●
Configuration Mode Selection		●	●	●	●	●
PM Alarms				●	●	●
View Memory Chip Data			●	●	●	●
<b>Passwords</b>						
Number of Passwords	0	1	Unlimited	Unlimited	Unlimited	Unlimited
Auto Timer lockout		●				
Adjustable Lockout Timer		●				
<b>Statistics</b>						
Sample and Population Stats		●	●	●	●	●
Stats Values Calculated		Cp,Cpk,Mean,SD, Capability, CAM, Max value, Min value % No. Rejects, % No Pass,No.Rej Hi, No. Rej Lo, Mean Shift, Range, No.for sigma			Cp,Cpk,Mean,SD, Capability, CAM, Max value, Min Value % No. Rejects, % No Pass, No.Rej Hi, No. Rej Lo,Mean Shift, Range, No.for sigma, Target	
Stats Alarms				●	●	●
Stats Alarms Output	●	●				
Max Sample Stats Size	200	1000	1000	1000	1000	1000
Powerhead Stats		●			●	●
Mean Range Charts				●	●	●
Histograms				●	●	●
Pareto chart				●	●	●
Stats E-mail alarms					●	●
Stats can be calculated from user defigned data				●	●	●
<b>Tightening Curves</b>						
Curve Types					Torque vs Angle, Torque vs Time, Current vs Time, Current vs Angle	
Max No. of Curves Stored on Cont.	Last Reject Last Cycle	Last Reject Last Cycle				
Display Curves On Screen				●	●	●



	Insight IC12M	Insight IC12D	Via ICS Connect	Via ICS Network	Via ICS MultiSync	Via ICS Enterprise
Print Tightening Curves				●	●	●
Print Tightening Curve Data				●	●	●
Full View				●	●	●
Zoom Function				●	●	●
No. of curves that can be overlaid				1	10	10
Archive curves					●	●
Parameter values shown on curve				●	●	●
<b>Tightening Strategies</b>						
Torque Control		●	●	●	●	●
Torque Control with Y. Override				●	●	●
Angle Control		●	●	●	●	●
Angle Control with Y. Override				●	●	●
Yield Control				●	●	●
Prevailing Torque				●	●	●
Drag Torque				●	●	●
Backout				●	●	●
Fault Backout					●	●
Final Fault Backout					●	●
Retorque				●	●	●
Wait				●	●	●
Jog				●	●	●
Bypass					●	●
<b>Communications</b>						
Serial E.O.R. Data out		●	●	●	●	●
Serial Custom E.O.R. Data			●	●	●	●
Host Data Out		●	●	●	●	●
PFCS					●	●
Barcode Passive				●	●	●
Barcode Active				●	●	●
Barcode setup onscreen				●	●	●
Field Bus setup onscreen				●	●	●
Ethernet Programming			●	●	●	●
<b>Diagnostics</b>						
Error Codes	●					
Text Errors		●	●	●	●	●
System Test		●	●	●	●	●
Store System Test Results			●	●	●	●
View Input Statuses		●	●	●	●	●
Set Output Statuses		●	●	●	●	●
View Outputs			●	●	●	●
Assignable inputs			●	●	●	●
Assignable Outputs			●	●	●	●
Event Log			●	●	●	●
View Event Log			●	●	●	●
Tool Test		●	●	●	●	●
Lamp Test		●	●	●	●	●
<b>Help</b>						
HelpOn Screen Help Menu			●	●	●	●
Wizard Text		●				
<b>Printed Reports</b>						
No. of Reports	0	0	5	6	9	11
Report Types			Cycle Log, Stats, Parameter Dump, Diagnostics, Event log			
				+ Tightening Curve,	+ Tightening, Curve Histogram, Pareto, Mean/Range	+ Tightening, Curve Histogram, Pareto, Mean/Range VIN, Custom
Parallel Output			●	●	●	●
Export to file			●	●	●	●
<b>Hardware</b>						
Screen Size	14 mm high x 5 character	9.6 cm (9/16 in) diag				
Screen Type	Red LED	1/4 VGA Color LCD	XVGA or better	XVGA or better	XVGA or better	XVGA or better
Keypad		●	●	●	●	●
Keypad Type		25 key Membrane	PC Keyboard	PC Keyboard	PC Keyboard	PC Keyboard
Status lights		On Screen				
Power On indication	●	●				
GFI	●	●				
Mounting Design	Wall or Cabinet mounting plate					
Field Bus	X (optional)	X (optional)				
No. of I/O	Base 8, Max 24	Base 8, Max 24				
Type of I/O	Opto	Opto				
Serial Port	X (1)	X (1)				
Ethernet	●	●				
Max number of Spindles	1	1	1	500	100	500
Method of identifying physical location	Rotary dial switch	Rotary dial switch				
CCT Breaker switch	●	●				
<b>Weight</b>						
Weight	5.6 kg (12.4 lb)	5.6 kg (12.4 lb)				

Accessories for Insight IC12Display & Insight IC12Module  
 Accessoires pour Insight IC12Display et Insight IC12Module  
 Zubehör für Insight IC12Display und Insight IC12Module  
 Accesorios para Insight IC12Display y Insight IC12Module  
 Accessori per Insight IC12Display e Insight IC12Module

Socket tray Boîte à douilles Nusskasten Bandeja de bocas Vassoio porta bussola	4 positions 8 positions	1
Remote selector switch Sélecteur de mode à distance Wählschalter (extern) Interruptor selector a distancia Interuttore di selezione remoto	4 positions 8 positions	2
Emergency stop button Bouton d'arrêt d'urgence Notausschalter Pulsador de parada de emergencia Pulsante di emergenza		3
Signal tower, type LCE-FB Tour de signalisation, type LCE-FB Signalturn, Typ LCE-FB "Signal tower", tipo LCE-FB "Signal tower", tipo LCE-FB		4
Reset station Poste de remise à zéro Reset-Schalter (extern) Estación de reposición Reset di stazione		5
Wall mounting bracket Kit pour fixation murale du controleur Wandmontagehalterung Sopporate para montaje mural Staffa montaggio a muro		
Cabinet mounting bracket Kit de fixation du controleur en armoire Schaltschrank-Montagehalterung Sopporate para montaje en armario Staffa montaggio armadio		
Parameter tranfer key Clé de transfert des paramètres Parameter Transfer Stick Llave de tranferenciade partametros Chiave trasferimento parametri		6

Please consult us for further details.  
 Nous consulter pour toute information complémentaire sur ces accessoires.  
 Für eine konkrete Beratung können Sie uns natürlich gerne kontaktieren.  
 Para más detalles sobre estos accesorios, por favor consultar.  
 Vogliate consultarci per ulteriori dettagli e chiarimenti su questi accessori.

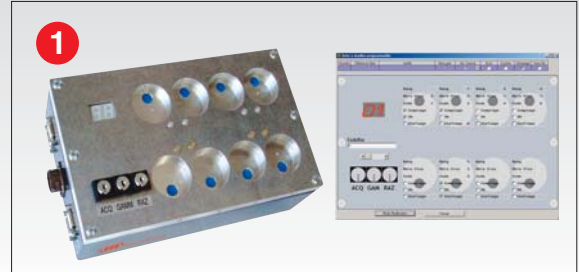





# Ergonomic Handling Systems

*Systèmes de Manutention Ergonomiques  
Ergonomische Handhabungstechnik  
Systemas de Manipulacion Ergonomicos  
Sistemi di Manutenzione Ergonomica*

95

**QTA Series**

Torque Reaction Arms  
Bras anti-réaction  
Drehmomentarme  
Brazos de reacción de par  
Bracci di reazione

98

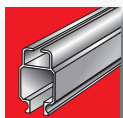

Rail systems  
Systèmes de rails  
Laufschienensysteme  
Sistemas de rieles  
Sistemi di rotaie

107

**B Series**

Spring balancers  
Équilibreur à ressort  
Federzüge  
Equilibradores  
Bilanciatori

108

**BW Series**

Pneumatic balancers  
Équilibreur pneumatiques  
Druckluft-Balancer  
Posicionadores de cargas neumáticos  
Posizionatori di carico pneumatici

112

**Intelift Series**

Pneumatic balancers  
Équilibreur pneumatiques  
Druckluft-Balancer  
Posicionadores de cargas neumáticos  
Posizionatori di carico pneumatici



**Bench-Mounted Torque Reaction Arms**  
**Bras anti-réaction pour montage sur table**  
**Drehmomentarme für Werkbankmontage**  
**Brazos de reacción para montaje sobre banco**  
**Bracci di reazione per montaggio a banco**

**QTA Series**



**Standard Equipment**

Anodized aluminum body on bearing and chrome plated pole

Die-cast aluminum spring balancer

Standard inline tool holder up to 100 Nm <sup>(1)</sup>

Cable management clips to route air hose or DC tool cable

Bras aluminium sur roulement et poteau acier chromé

Équilibreur à ressort en fonte d'aluminium

Support pour visseuse droite jusque 100 Nm <sup>(1)</sup>

Clips de fixation du flexible d'alimentation (pour outils pneumatiques ou électriques)

Lagerung aus eloxiertem Aluminium und verchromte Hubstange

Federzug mit Aluminium-Guss-Gehäuse

Universal-Werkzeugaufnahmen für Geradschrauber bis 100 Nm <sup>(1)</sup>

Clips zur Befestigung der Kabel bzw. Druckluftleitungen

Cuerpo de aluminio anodizado sobre rodamiento y columna cromada

Equilibrador en fundición de aluminio

Soporte de herramienta recto estándar hasta 100 Nm <sup>(1)</sup>

Conectores de fijación para manguera de aire ó cable eléctrico

Corpo in alluminio anodizzato con cuscinetti per scorrimento su tubo cromato

Bilanciatore integrato in alluminio

Supporto std per soli chiavi diritte sino a 100 Nm <sup>(1)</sup>

Fissazioni di cavo per utensili pneumatici o elettrici



<sup>(1)</sup> See following page for other tool holders.





Voir page suivante pour les autres types de supports disponibles.

Auf den folgenden Seiten finden Sie weitere Werkzeugaufnahmen.

Ver página siguiente para otras bridas de herramienta.

Vedi pagine seguenti per i vari tipi di supporto disponibili.

**Specifications • Caractéristiques**  
**Technische Daten • Especificaciones • Caratteristiche**

Ref.	 Max. Nm	 kg	 A	 B	 C
	Nm	kg	mm	mm	mm
<b>QTA010</b>	10	1.2	380	330	706
<b>QTA020</b>	20	2.3	508	368	808
<b>QTA040</b>	40	3.0	635	445	1008
<b>QTA100</b>	100	3.6	762	445	1008
<b>QTA150 <sup>(2)</sup></b>	150	4.5	1321	559	2000



<sup>(2)</sup> The QTA150 can be easily configured as either a bench-mounted or floor-mounted torque arm, and reconfigured as the job demands.

Le modèle QTA150 est utilisable en montage sur table ou montage au sol et peut être rapidement reconfiguré en fonction des applications.

Der QTA150 ist als Werkbankvariante oder Standvariante einfach zu montieren, nach Einsatzzweck.

El brazo QTA150 se puede configurar fácilmente para aplicaciones sobre banco ó suelo según la necesidad.

Il QTA150 può essere facilmente configurato sia come montaggio su banco sia montaggio a pavimento, a seconda del lavoro da effettuare.



**QTA  
Series**

**Floor-Mounted Torque Reaction Arms**  
**Bras anti-réaction pour montage au sol**  
**Drehmomentarme für Bodenmontage**  
**Brazos de reacción para montaje sobre suelo**  
**Bracci di reazione per montaggio al suolo**



**Standard  
Equipment**

**Adjustable  
arm height  
at column**

Hauteur réglable  
sur colonne

Säule  
höhenverstellbar

Altura  
ajustable  
en la columna

Altezza braccio  
regolabile su  
colonna

**Air cylinders  
and regulator**

Vérins avec  
régulateur  
pneumatique

Druckluftzylinder  
und  
entsprechende  
Regler

Cilindros  
neumáticos y  
regulador

Cilindro con  
regolatore  
pneumatico

**Cable  
management  
clips to route  
air hose or DC  
tool cable**

Clips de fixation  
du flexible  
d'alimentation  
(pour outils  
pneumatiques ou  
électriques)

Kabel bzw.  
Druckleitungen  
werden mit  
Clips befestigt  
und geführt

Conectores de  
fijación para  
manguera de  
aire ó cable  
eléctrico

Fissazioni di  
cavo per utensili  
pneumatici o  
elettrici

**Safety stop**

Butée de  
sécurité

Sicherheitsstopp

Bloqueo de  
seguridad

Protezione di  
arresto

**Specifications • Caractéristiques**  
**Technische Daten • Especificaciones • Caratteristiche**

Ref.	Max. Nm	kg	A mm	B mm	C mm
QTA270	270	10	1524	477	2000
QTA475	475	23	2007	590	2000

**Generic clamp style tool holders**  
**Supports de visseuses universels**  
**Allgemeine Werkzeug Halteklammern**  
**Brida de fijación de herramientas universales**  
**Porta utensili stile pinza generica**



Type - Tipo	QTA010	QTA020	QTA040	QTA100
● Inline (included with arm)	ITC010-1C	ITC040-1C	ITC040-1C	ITC100-1C
① Right Angle	ATC010-1C	ATC040-1C	ATC040-1C	ATC100-1C
② Pistol	PTC010-1C	PTC040-1C	PTC040-1C	-
③ Rotating	RTC010-1C	RTC040-1C	RTC040-1C	-
④ 1/4" NPT	NTC010-1T	-	-	-

Generic tool holders are available for arms up to 100 Nm (these arms are delivered with an inline tool holder as standard).  
 Flange mounting is recommended for inline tools with torque capacity above 40 Nm.  
 Please note the tool diameter range for generic holders: QTA010: 25 – 40 mm, QTA020 / QTA040 / QTA100: 28 – 52 mm.

Les supports d'outil génériques sont disponibles pour bras jusque 100 Nm (ces bras sont livrés avec un support droit en standard).  
 Le montage par bride est recommandé pour les outils de plus de 40 Nm – Le diamètre de fixation de l'outil sur le support est réglable et différent selon les modèles: sur QTA010 = 25 à 40 mm – Sur QTA020, QTA040 et QTA100 = 28 à 52 mm.

Universal-Werkzeugaufnahmen sind bis zu 100 Nm Werkzeugdrehmoment verfügbar (diese Arme werden mit einer Ausführung für Geradschrauber ausgeliefert).  
 Eine Flanschmontage wird für gerade Schrauber ab einem Drehmoment von 40 Nm empfohlen.  
 Bitte beachten Sie die maximalen Werkzeugdurchmesser bei den Universal-aufnahmen: QTA010: 25 - 40 mm, QTA020 / QTA040 / QTA100: 28 - 52 mm.

Bridas de herramienta genéricas disponibles para brazos hasta 100 Nm (estos brazos se suministran con bridas para herramientas rectas como estándar).  
 Montaje con brida se recomienda para herramientas rectas con capacidad de par superior a 40 Nm – Por favor verificar la gama de diámetros de la herramienta para bridas genéricas: QTA010 = 25 a 40 mm – QTA020, QTA040 y QTA100 = 28 a 52 mm.

Opzioni di fissaggio generiche sono disponibili sino a 100 Nm (questi modelli sono forniti con fissaggi per chiavi diritte come standard).  
 Il montaggio su flangia è consigliato per chiavi diritte con capacità a partire dai 40 Nm – Vogliate notare i seguenti valori di diametro per i porta utensili generici: QTA010 = 25 a 40 mm – QTA020, QTA040 e QTA100 = 28 a 52 mm.





Ingersoll Rand QA Series and QE Series tool holders  
 Supports pour visseuses QA et QE Ingersoll Rand  
 Werkzeugaufnahmen für Ingersoll Rands QA- und QE-Produktlinien  
 Bidas para modelos Ingersoll Rand de la serie QA y QE  
 Porta utensili per serie QA e QE Ingersoll Rand



Ingersoll Rand Tools	QTA010	QTA020	QTA040	QTA100	QTA150	QTA270	QTA475
<b>QE4</b> 	-	CTC040-K1B	CTC040-K1B	-	-	-	-
<b>QE4</b> 	CTC040-K1P	CTC040-K1P	CTC040-K1P	-	-	-	-
<b>QE6</b>	-	CTC040-K2B	CTC040-K2B	CTC100-K2B	-	-	-
<b>QE8</b> with  (GEM120-K48)	-	-	-	CTC100-K2B	CTC150-K2B	-	-
<b>QE8</b> with  (integrated flange)	-	-	-	CTC100-K3B	CTC150-K3B	CTC270-K3B	-
<b>QE8</b>  230 Nm	-	-	-	-	-	CTC270-K4B	-
<b>QE8</b>  400 Nm	-	-	-	-	-	-	CTC475-K5B
<b>QA4</b> 	-	CTC040-K6B	CTC040-K6B	CTC100-K6B	-	-	-
<b>QA4</b>  < 28 Nm & <b>QA6</b>	-	CTC040-K1B	CTC040-K1B	CTC100-K1B	-	-	-
<b>QA4</b>  46 Nm	-	-	-	CTC100-K2B	-	-	-
<b>QA8</b>  < 151 Nm	-	-	CTC040-K1B	CTC100-K1B	CTC150-K2B	-	-
<b>QA8</b>  < 56 Nm	-	-	CTC040-K1B	CTC100-K1B	CTC150-K2B	-	-
<b>QA8</b>  > 150 Nm	-	-	-	CTC100-K2B	CTC150-K3B	CTC270-K3B	-
<b>QA8</b>  > 55 Nm	-	-	-	CTC100-K2B	CTC150-K3B	CTC270-K3B	-

Note: Every Ingersoll Rand QE- or QA-specific tool holder listed in the table above accepts both angle and inline tools but requires an integrated flanged gear case or bolt-on mounting flange to attach the tool holder to the tool.

If your tool came with mounting style P (with letter "P" in the model number) order Part No. 15E4-K48 for any Ingersoll Rand-specific tool holder that ends with "1B" — Order Part No. GEM120-K48 for any Ingersoll Rand-specific tool holder that ends with "2B" — Order Part No. QA4-K48 for any Ingersoll Rand-specific tool holder that ends with "6B".

Nota : Tous les supports pour visseuses QE et QA Ingersoll Rand énumérés dans le tableau ci-dessus permettent le montage de machines droites ou d'angle à condition qu'elles soient équipées d'une bride ou d'une plaque de montage.

Si votre visseuse est un modèle "P" (machine dont la référence incorpore une lettre P), il est nécessaire de commander aussi la référence 15E4-K48 pour tout support de visseuse se terminant par "1B" — Pout tout support de visseuse se terminant par "2B", il est nécessaire de commander la référence GEM120-K48 — Pout tout support de visseuse se terminant par "6B", il est nécessaire de commander la référence QA4-K48.

Bitte beachten: Jeder der Aufnahmen für Ingersoll Rand Werkzeuge können für Geradschrauber und Winkelschrauber verwendet werden. Die Werkzeuge müssen aber mit der Flansch-Option am Getriebe konfiguriert sein. Falls Ihr Werkzeug mit der Montageversion P (an einem "P" in der Modellnummer ersichtlich) konfiguriert ist, wählen Sie:

Aufnahme Nr. 15E4-K48, für Werkzeuge, die mit "1B" enden.

Aufnahme Nr. GEM120-K48, für Werkzeuge, die mit "2B" enden.

Aufnahme Nr. QA4-K48, für Werkzeuge, die mit "6B" enden.

Nota : cada brida especificada aquí para la serie QE y QA admite herramientas rectas y angulares pero requiere una brida integrada en la zona de engranajes de desmultiplicación ó brida atornillada para fijar a la brida del brazo.

Si la herramienta viene para se montada tipo "P" (lleva la letra "P" en el modelo), pida la referencia No. 15E4-K48 para cualquier modelo específico de brida Ingersoll Rand que acabe en "1B" — Pida la referencia No. GEM120-K48 para cualquier modelo de brida Ingersoll Rand que acabe en "2B" — Pida la referencia No. QA4-K48 para cualquier modelo de brida de Ingersoll Rans que acabe en "6B".

Nota: Tutti i porta utensili per QA & QE elencati, sono compatibili per entrambe le versioni ad angolo od diritte ma richiedono una flangia integrata. Se l'utensili ha la sigla con la lettera "P" (tipo di montaggio) ordinare il cod. 15E4-K48, per ogni porta utensili che termina con "1B" — Ordinare il cod. GEM120-K48 per ogni porta utensile che termina con "2B" — Ordinare il cod. QA4-K48 per ogni porta utensile che termina con "6B".

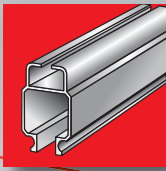

**Rail systems**  
**Systèmes de rails**  
**Laufschienensysteme**  
**Sistemas de rieles**  
**Sistemi di rotaie**

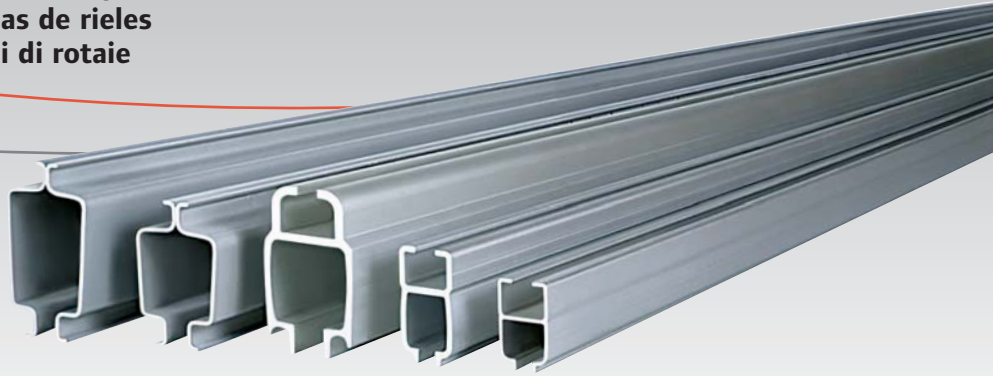

Thanks to the quality of the rolling surfaces, the guidance of the trolleys and the articulated suspensions, Ingersoll Rand systems allow you to move loads with a maximum starting force of 1.5 % of the total load (bridge plus load). Furthermore, the rolling effort required during displacement is less than 1 % – even if the load is pushed far away from the centre of the bridge (see sketches).

Grâce à la qualité des surfaces de roulement, au guidage des chariots et aux suspensions articulées, les systèmes Ingersoll Rand permettent de déplacer les charges avec un effort de mise en mouvement inférieur à 1,5% de la masse totale déplacée (masse du pont roulant + charge). L'effort de poussée (résistance au roulement) correspond ensuite à moins de 1% lors de la translation, même avec une poussée désaxée (voir figures ci-contre).

Aufgrund der Oberflächengüte der Laufflächen, der Führung der Fahrwerke und der drehbaren Aufhängungen, können mit Systemen von Ingersoll Rand Lasten mit einer Anlaufkraft verfahren werden, die maximal 1,5% der Gesamtlast ausmacht (Kranträger plus Anhängelast). Zudem beträgt die erforderliche Schubkraft für das Verfahren weniger als 1% - selbst wenn die Last weit außermittig verschoben ist (siehe Zeichnungen).

Gracias a la calidad de las superficies de rodadura, la guía de los carros y las suspensiones articuladas, los sistemas Ingersoll Rand permiten desplazar cargas con una fuerza inicial máxima de 1,5% de la carga total (puente y carga sumados). Es más, el esfuerzo de rodadura que se requiere durante el desplazamiento es menos del 1%, incluso si la carga se empuja lejos del centro del puente (ver las ilustraciones).

Grazie alla qualità della superficie, il sistema rotante, la guida dei carrelli e delle sospensioni articolate, il sistema Ingersoll Rand consente di spostare carichi con una massima forza iniziale del 1,5% del carico totale (ponte più carico). Per di più, lo sforzo richiesto durante lo spostamento è inferiore al 1% anche quando il carico è spinto lontano dal centro del ponte (vedi figura).

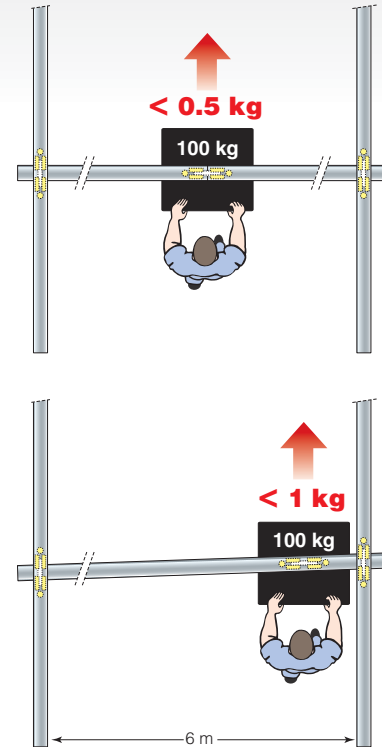

<b>Starting</b> Mise en mouvement Anlauf Inicio Partenza	<b>Moving</b> Déplacement Verfahren Desplazamiento Traslazione	<b>Positioning</b> Positionnement Positionieren Posicionamiento Posizionamento
--	--	--

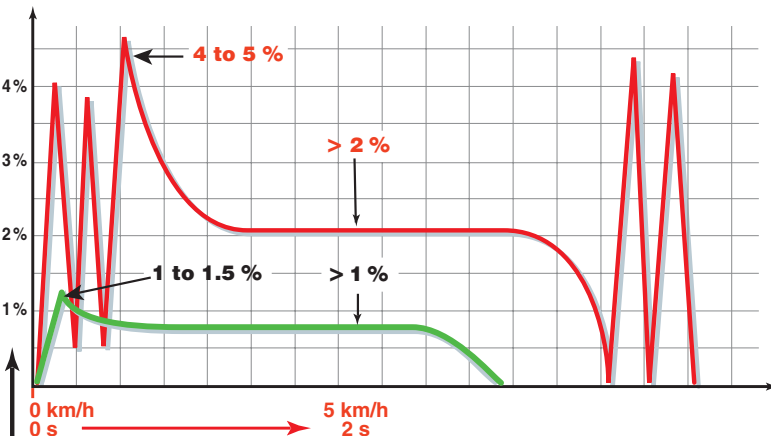

- Typical Enclosed Rail Systems  
 Rails à profil fermé classiques  
 Typische Profilschienensysteme  
 Sistemas integrados de rieles típicos  
 Sistemi di rotaie a profilo chiuso
- Ingersoll Rand Enclosed Rail Systems  
 Rails à profil fermé Ingersoll Rand  
 Ingersoll Rand Profilschienensysteme  
 Sistemas integrados de rieles Ingersoll Rand  
 Sistemi di rotaie a profilo chiuso Ingersoll Rand

Manual effort applied Effort appliqué Aufgebrachter Kraftaufwand Esfuerzo manual aplicado Sforzo manuale applicato	Time Temps Zeit Tiempo Tempo
--	--

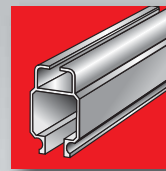

Typical system illustration\*  
Illustration d'un système typique\*  
Typisches System\*  
Ilustración de sistema típico\*  
Illustrazione sistema tipo\*

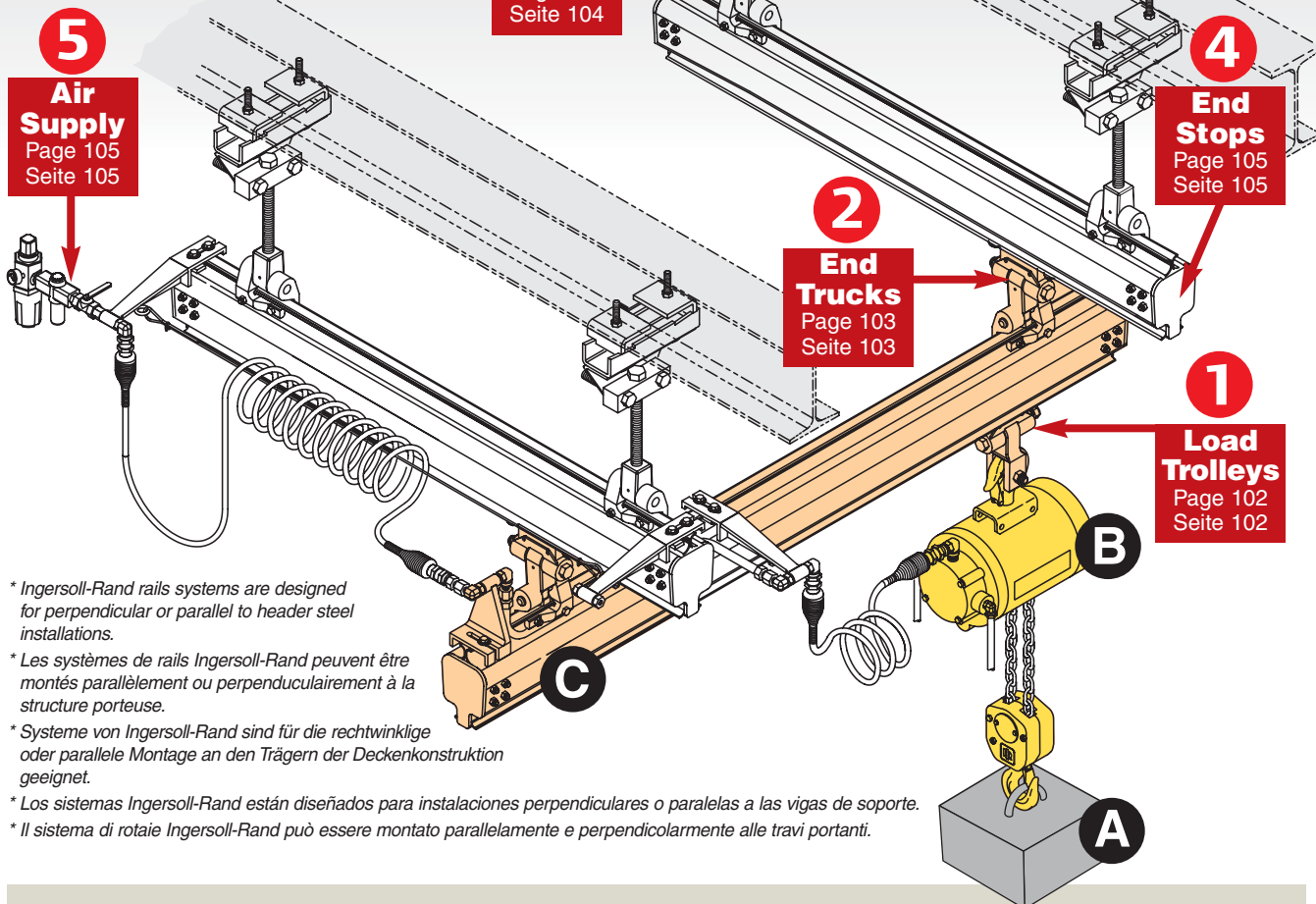

\* Ingersoll-Rand rails systems are designed for perpendicular or parallel to header steel installations.

\* Les systèmes de rails Ingersoll-Rand peuvent être montés parallèlement ou perpendiculairement à la structure porteuse.

\* Systeme von Ingersoll-Rand sind für die rechtwinklige oder parallele Montage an den Trägern der Deckenkonstruktion geeignet.

\* Los sistemas Ingersoll-Rand están diseñados para instalaciones perpendiculares o paralelas a las vigas de soporte.

\* Il sistema di rotaie Ingersoll-Rand può essere montato parallelamente e perpendicolarmente alle travi portanti.

**WARNING:** To correctly calculate the load capacity of each component described in the next pages, please apply the following rule of calculation: **A + B + (C:2)**. **A** = Load to be moved, **B** = Balancer or hoist weight, **C** = Weight of the lower rails and trolleys divided by 2.

**ATTENTION:** Pour calculer la capacité de charge requise pour chacun des élément présentés dans les pages suivantes, appliquer la règle de calcul **A + B + (C:2)**. **A** = Charge à déplacer, **B** = poids de l'équilibreur ou du palan, **C** = poids des rails inférieurs et chariots divisé par 2.

**ACHTUNG:** Für eine korrekte Kalkulation der max. Traglast der Bauteile auf den folgenden Seiten, verwenden Sie bitte folgende Berechnungsregel: **A + B + (C:2)**. **A** = Bewegte Last (Werkstück), **B** = Gewicht Hebezeug, **C** = Gewicht der unteren Schienen inkl. Trolleys geteilt durch 2.

**ADVERTENCIA:** para calcular correctamente la capacidad de carga de cada componente descrito en las siguientes páginas, por favor aplicar la siguiente regla de cálculo: **A + B + (C:2)**. **A** = carga a mover, **B** = peso equilibrador ó polipasto, **C** = peso de los railes inferiores y carros dividido por 2.

**ATTENZIONE:** Per calcolare correttamente il valore del carico pe rogni parte descritta nella pagina seguente, vogliate considerare la seguente formula **A + B + (C:2)**. **A** = Carico da movimentare, **B** = peso del bilanciatore o del paranco, **C** = il peso più basso delle rail e carrelli diviso per 2.

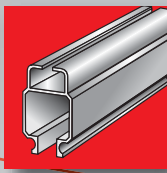

**Rail systems**  
**Systèmes de rails**  
**Laufschienensysteme**  
**Sistemas de rieles**  
**Sistemi di rotaie**

Span (m) / Load capacity (kg)  
 Portée (m) / Capacité de charge (kg)  
 Spannweite (m) / Traglast (kg)  
 Luz (m) / Capacidad de carga (kg)  
 Portata (m) / Capacità (kg)

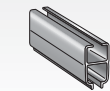
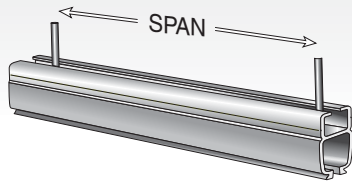

**ZRAT**  
 (1 m = 3.0kg)  
**ALUMINIUM**

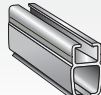

**ZRA1**  
 (1m = 5.5kg)  
**ALUMINIUM**

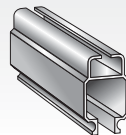

**ZRA2**  
 (1m = 11.3kg)  
**ALUMINIUM**

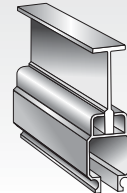

**ZRA2T**  
 (1m = 22.3)  
**ALUMINIUM**

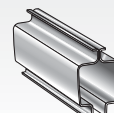

**ZRS2**  
 (1m = 11.9kg)  
**STEEL**

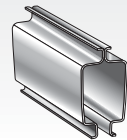

**ZRS3**  
 (1m = 13.2kg)  
**STEEL**

Span • Portée • Spannweite • Luz • Portata	Load capacity (kg) • Capacité de charge (kg) • Traglast (kg) • Capacidad de carga • Capacità (kg)					
	Deflexion 1/450 • Déflexion 1/450 • Biegung 1/450 • Deflexión 1/450 • Flessione 1/450					
1 m	372	734	1361	1361	1293	1293
1,5 m	311	734	1361	1361	1293	1293
2 m	175	595	1361	1361	1293	1293
2,5 m	112	381	1361	1361	1219	1293
3 m	78	264	1011	1361	847	1293
3,5 m	57	194	742	1361	622	1074
4 m	44	149	568	1361	476	823
4,5 m	35	118	449	1361	376	650
5 m	28	95	364	1361	305	526
5,5 m	23	79	301	1361	252	435
6 m	19	66	253	1361	212	366
6,5 m	–	56	215	1361	180	312
7 m	–	49	186	1206	156	279
7,5 m	–	42	162	1051	–	–
8 m	–	37	142	923	–	–
8,5 m	–	33	126	818	–	–
9 m	–	29	112	–	–	–

	Deflexion 1/500 <sup>(1)</sup> • Déflexion 1/500 <sup>(1)</sup> • Biegung 1/500 <sup>(1)</sup> • Deflexión 1/500 <sup>(1)</sup> • Flessione 1/500 <sup>(1)</sup>					
1 m	372	734	1361	1361	1293	1293
1,5 m	280	734	1361	1361	1293	1293
2 m	157	536	1361	1361	1293	1293
2,5 m	101	343	1310	1361	1097	1293
3 m	70	238	909	1361	762	1293
3,5 m	51	175	668	1361	560	967
4 m	39	134	512	1361	429	740
4,5 m	31	106	404	1361	339	585
5 m	25	86	327	1361	274	474
5,5 m	21	71	271	1361	227	392
6 m	17	60	227	1361	190	329
6,5 m	–	51	194	1259	162	280
7 m	–	44	167	1085	140	242
7,5 m	–	38	146	946	–	–
8 m	–	33	128	831	–	–
8,5 m	–	30	113	736	–	–
9 m	–	26	101	–	–	–

(1) UK standard – Norme britannique – Englische Norm – Norma inglesa – Norma inglese.

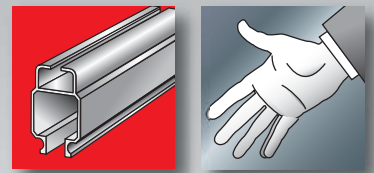

Rails ordering menu  
Menu de commande des rails  
Schienen-Bestellenmenü  
Codificación de los carriles  
Informazioni per l'ordinazione di rotaie

**Rail for RUNWAY per unit — Rail pour VOIE DE ROULEMENT par unité — Schiene für LAUFBAHN durch Einheit — Carril para VIA DE RODADURA por unidad — Rail per VIA DI CORSA singola**

**Standard delivery package:** Individually packed runway rail drilled for end stop and redundant end stop.

**Conditionnement:** Rail de roulement avec perçages pour butées de fin de rail et butées redondantes, conditionné individuellement.

**Standardlieferungumfang:** gebohrte Laufschiene für Endanschläge und redundante Endanschläge, einzeln verpackt.

**Se entrega de serie:** la viga de rodadura con los agujeros hechos para los topes final y redundante.

**Pacchetto standard fornito:** Pacchetto individuale di via di corsa forato per gli stop di fine corsa e gli stop di fine corsa respingenti.

Example • Exemple • Beispiel • Ejemplo • Esempio : **30000 -4550 -2**

Rail model Type de rail Schienen-Typ Tipo del carril Tipo rotaia	Overall length Longueur hors tout Gesamtlänge Longitud total Lunghezza totale	Splice lugs <sup>(1)</sup> Oreilles de liaison <sup>(1)</sup> Verbindungsglaschen <sup>(1)</sup> Conexión entre rieles <sup>(1)</sup> Boccole di collegamento <sup>(1)</sup>
31000 = ZRAT (6 m max.)	-XXXX = Length in mm	-2 = Welded splice lug for rail connection
30200 = ZRA1 (9 m max. - Longer lengths available on request)	-XXXX = Longueur en mm	-2 = Oreilles de liaison des rails soudées
30000 = ZRA2 (9 m max. - Longer lengths available on request)	-XXXX = Länge in mm	-2 = Geschweißte Verbindungsglasche für Laufschienen
30500 = ZRS2 (7 m max.)	-XXXX = Longitud en mm.	-2 = Uniones para la conexión entre rieles
30550 = ZRS3 (7 m max.)	-XXXX = Lunghezza in mm	-2 = Boccole di collegamento tra rotaie

<sup>(1)</sup> No splice lug for ZRAT — Pas d'oreilles de liaison sur rails ZRAT — Keine Verbindungsglasche für ZRAT — No son necesarias las uniones entre perfiles ZRAT — No boccole di collegamento per ZRAT.

**Rail for BRIDGE per unit — Rail pour POUTRE MOBILE par unité — Schiene für BRÜCKE durch Einheit — Carril para VIGA PUENTE por unidad — Rail per via di corsa su PONTE MOBILE**

**Standard delivery package:** Individually packed bridge rail drilled for end stop, redundant end stop, end trucks and safety cables.

Delivered with two end stops and two safety cables.

**Conditionnement:** Rail poutre mobile avec perçages pour butées de fin de rail, butées redondantes, chariots support de poutre et câbles de sécurité — Conditionné individuellement avec 2 butées de fin de rail et 2 câbles de sécurité.

**Standardlieferungumfang:** Querschiene mit Bohrungen für Endanschläge, redundante Anschläge, Laufwagen und Sicherheitsseile. Einzeln verpackt mit 2 Endanschläge und 2 Sicherheitsseile.

**Se entrega de serie:** la viga puente con los agujeros hechos para los topes final y redundante, para los carros del puente y para los cables de seguridad. Se incluyen de serie dos topes finales y dos cables de seguridad.

**Pacchetto standard fornito:** Pacchetto individuale di via di corsa per ponte mobile forato per gli stop di fine corsa, gli stop di fine corsa respingenti, i carrelli per il ponte mobile e i cavi di sicurezza. Fornito con 2 stop di fine corsa e 2 cavi di sicurezza.

Example • Exemple • Beispiel • Ejemplo • Esempio : **ZRA2 -3500 -4000 -R**

Rail model Type de rail Schienen-Typ Tipo del carril Tipo rotaia	Span Portée Spannweite Luz Corsa utile	Overall length Longueur hors tout Gesamtlänge Longitud total Lunghezza totale	Option Option Option Option Opzione
ZRAT (6 m max.)	Span in mm	Length in mm (standard = span + 500 mm)	-R = Redundant end stops
ZRA1 (9 m max.)	Portée en mm	Longueur en mm (standard = portée + 500 mm)	-R = Butées redondantes
ZRA2 (9 m max.)	Spannweite in mm	Länge in mm (Standard = Spannweite + 500 mm)	-R = Redundante Anschläge
ZRA2T (9 m max.)	Luz en mm.	Longitud en mm. (estándar = Luz + 500 mm.)	-R = Topes finales redundantes
ZRS2 (7 m max.)	Corsa utile in mm	Lunghezza in mm (Standard = corsa + 500 mm)	-R = Fine corsa respingente
ZRS3 (7 m max.)			

(Longer lengths available on request)

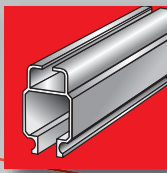

**Rail systems**  
**Systèmes de rails**  
**Laufschienensysteme**  
**Sistemas de rieles**  
**Sistemi di rotaie**

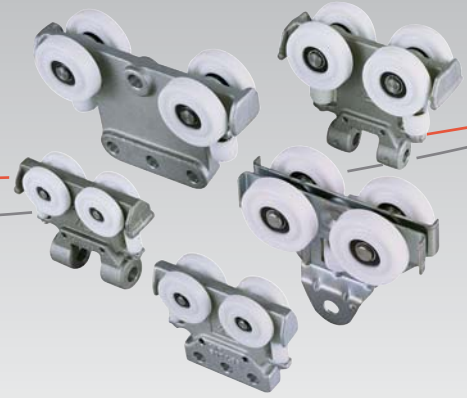

**1 Load trolleys • Chariots de translation sous poutres mobiles •  
 Laufwagen für Profilschienen • Carro de traslación • Carrelli di traslazione**



For use with:  
 Pour utilisation avec:  
 In Verbindung mit:  
 Para uso con:  
 Per utilizzo con:

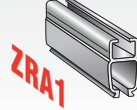

Simple trolley Chariot simple Einfacher Laufwagen Carro sencillo Carrello semplice		SWL 227 kg Ref. 31057	SWL 227 kg Ref. 30281	SWL 454 kg Ref. 30172	SWL 454 kg Ref. 30821	SWL 454 kg Ref. 30821
Load trolley (with suspension axle) Chariot avec axe de suspension Lastenlaufwagen Carro de carga Carrello di sospensione (con asse di sosp.)		—	SWL 227 kg Ref. 30304	SWL 454 kg Ref. 30923	SWL 454 kg Ref. 30842	SWL 454 kg Ref. 30842
Hoist trolley Chariot porte-palan Laufwagen für Hebezeuge Carro de polipasto Carrello porta paranco		SWL 227 kg Ref. 31058	SWL 227 kg Ref. 30313	SWL 454 kg Ref. 30314	SWL 454 kg Ref. 30315	SWL 454 kg Ref. 30315
Dual hoist trolley Chariots jumelés porte-palan Doppelter Laufwagen für Hebezeuge Carro doble de polipasto Doppio carrello porta paranco		—	SWL 454 kg Ref. 30303	SWL 908 kg Ref. 30906	SWL 908 kg Ref. 30830	SWL 908 kg Ref. 30830
3 hole trolley Chariot large 3-Loch-Laufwagen Carro de 3 agujeros Carrello largo		SWL 227 kg Ref. 31056	SWL 227 kg Ref. 30279	SWL 454 kg Ref. 30015	SWL 454 kg Ref. 30510	SWL 454 kg Ref. 30510
Reaction trolley (for cantilevered loads) Chariot 3 roues (pour portes-à-faux) Reaktionslaufwagen (für vortragende Lasten) Carro de reacción (para cargas descentradas) Carrello di reazione (per travi a sbalzo)		—	—	SWL 454 kg Ref. 30016	SWL 454 kg Ref. 30511	—
Bumper trolley Chariot de butée Anschlaglaufwagen Carro paragolpes Carrello respingente		—	30307-1200 30307-2400 30307-3600 30307-4800	30148-1200 30148-2400 30148-3600 30148-4800	30148-1200 30148-2400 30148-3600 30148-4800	30148-1200 30148-2400 30148-3600 30148-4800
	Ref. XXXX-1200, L = 305 mm Ref. XXXX-2400, L = 610 mm Ref. XXXX-3600, L = 915 mm Ref. XXXX-4800, L = 1220 mm					

**Curved rails for ZRA1 monorail installations**  
**Rails courbes pour installations monorails ZRA1**  
**Gebogene Schienen für ZRA1 Monoschiene-Installationen**  
**Railes curvos para instalaciones monorail ZRA1**  
**Travi curve per installazione monorotaie ZRA1**



		Ref.
914 mm	15°	30254
914 mm	30°	30255
914 mm	45°	30256
914 mm	60°	30257
914 mm	90°	30258

**Note:** The ZRA1 monorails use the same components as the ZRA1 bridge cranes (hanger kits, load trolleys, etc), except dual hoist trolley, ref. 30303.

**Nota:** Les configurations monorails ZRA1 utilisent les mêmes composants que les poutres mobiles ZRA1 (suspensions, chariots de charge, etc), sauf chariot jumelé porte-palan, réf. 30303.

**Anmerkung:** Mit ZRA1 Monoschiene werden die gleichen Komponenten wie mit ZRA1-Brücken verwendet (Aufhängungen, Laufwagen etc.) außer Doppelter Laufwagen für Hebezeuge, Ref. 30303.

**Nota:** los monorrailes ZRA1 usan los mismos componentes que la viga puente ZRA1 (Kit de suspensión de carros de carga, etc) excepto el carro doble de polipasto, ref. 30303.

**Nota:** La configurazione monorotaie ZRA1 utilizza gli stessi componenti dei carri ponti ZRA1 (sospensioni, carrelli di carico, etc...) ad eccezione del doppio carrello per paranco, rif. 30303.

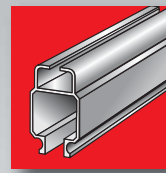

2

End trucks • Chariots supports de poutres mobiles  
Brückenfahrwagen • Suspensiones del puente  
Sospensioni per ponte mobile

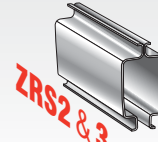
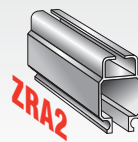
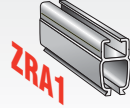
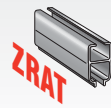

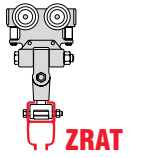
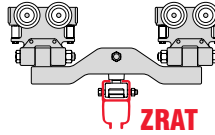
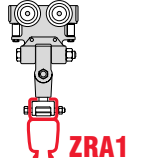
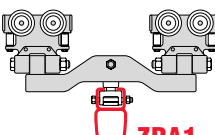
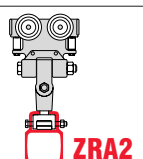
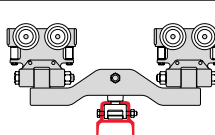
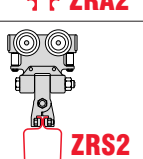
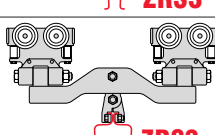
 <b>Z RAT</b>	SWL 227 kg Ref. 31059	SWL 227 kg Ref. 30283	SWL 454 kg Ref. 30909	SWL 454 kg Ref. 30822	SWL 227 kg Ref. 30283	SWL 454 kg Ref. 30639
 <b>Z RAT</b>	SWL 454 kg Ref. 31060	SWL 454 kg Ref. 30286	SWL 908 kg Ref. 30911	SWL 908 kg Ref. 30826	SWL 454 kg Ref. 30286	SWL 908 kg Ref. 30846
 <b>Z RA1</b>	SWL 227 kg Ref. 31059	SWL 227 kg Ref. 30283	SWL 454 kg Ref. 30909	SWL 454 kg Ref. 30822	SWL 227 kg Ref. 30283	SWL 454 kg Ref. 30639
 <b>Z RA1</b>	SWL 454 kg Ref. 31060	SWL 454 kg Ref. 30286	SWL 908 kg Ref. 30911	SWL 908 kg Ref. 30826	SWL 454 kg Ref. 30286	SWL 908 kg Ref. 30846
 <b>Z RA2</b>	—	SWL 227 kg Ref. 30295	SWL 454 kg Ref. 30176	SWL 454 kg Ref. 30824	SWL 227 kg Ref. 30295	SWL 454 kg Ref. 30927
 <b>Z RA2</b>	—	SWL 454 kg Ref. 30272	SWL 908 kg Ref. 30177	SWL 908 kg Ref. 30828	SWL 454 kg Ref. 30272	SWL 908 kg Ref. 30643
 <b>Z RS2 Z RS3</b>	—	SWL 227 kg Ref. 30320	SWL 454 kg Ref. 30913	SWL 454 kg Ref. 30597	SWL 227 kg Ref. 30320	SWL 454 kg Ref. 30563
 <b>Z RS2 Z RS3</b>	—	SWL 454 kg Ref. 30298	SWL 908 kg Ref. 30915	SWL 908 kg Ref. 30599	SWL 454 kg Ref. 30298	—

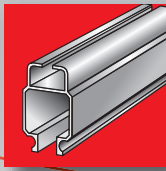

**Rail systems**  
**Systèmes de rails**  
**Laufschienensysteme**  
**Sistemas de rieles**  
**Sistemi di rotaie**



**3** Hanger kits • Suspensions sous structure IPN, IPE, etc •  
 Aufhängegesätze • Soportes de suspensión • Kits di sospensione su travi



For use with:  
 Pour utilisation avec:  
 In Verbindung mit:  
 Para uso con:  
 Per utilizzo con:

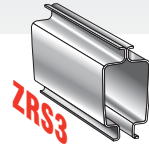
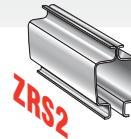
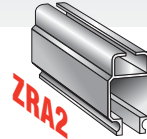
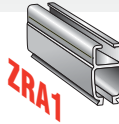
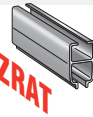

ADJUSTABLE (± 22 mm) AJUSTABLE (± 22 mm) EINSTELLBAR (± 22 mm) AJUSTABLE (± 22 mm) REGOLABILE (± 22 mm)			H = 287 mm 30287-006	H = 287 mm 30287-006	H = 295 mm 30195-006	H = 273 mm 30814-006	H = 273 mm 30814-006
			H = 439 mm 30287-012	H = 439 mm 30287-012	H = 447 mm 30195-012	H = 425 mm 30814-012	H = 425 mm 30814-012
			H = 287 mm 30288-006	H = 287 mm 30288-006	H = 295 mm 30196-006	H = 273 mm 30815-006	H = 273 mm 30815-006
			H = 439 mm 30288-012	H = 439 mm 30288-012	H = 447 mm 30196-012	H = 425 mm 30815-012	H = 425 mm 30815-012
SHORT COURTE KURZ CORTO CORTO			H = 156 mm 30300	H = 156 mm 30300	H = 164 mm 30921	H = 142 mm 30840	H = 142 mm 30840
			H = 156 mm 30301	H = 156 mm 30301	H = 164 mm 30922	H = 142 mm 30841	H = 142 mm 30841
PARALLEL BEAM FER PORTEUR PARALLELE PARALLEL ZUM TRÄGER VIGA PARALELA TRAVE PARALLELA			H = 292 mm 30290	H = 292 mm 30290	H = 301 mm 30199	H = 279 mm 30817	H = 279 mm 30817
			H = 292 mm 30291	H = 292 mm 30291	H = 301 mm 30900	H = 279 mm 30818	H = 279 mm 30818
		Block mount	H = 244 mm 30289	H = 244 mm 30289	H = 253 mm 30198	H = 231 mm 30816	H = 231 mm 30816
PERPENDICULAR BEAM FER PORTEUR PERPENDICULAIRE RECHTWINKLIG ZUM TRÄGER VIGA PERPENDICOLARE TRAVE PERPENDICOLARE			H = 292 mm 30292	H = 292 mm 30292	H = 301 mm 30901	H = 279 mm 30819	H = 279 mm 30819
			H = 292 mm 30293	H = 292 mm 30293	H = 301 mm 30902	H = 279 mm 30820	H = 279 mm 30820
		Block mount	H = 244 mm 30285	H = 244 mm 30285	H = 253 mm 30193	H = 231 mm 30813	H = 231 mm 30813
RIGID RIGIDE STARR RIGIDA RIGIDO		Rigid mount	30227	30227	30052		





**Rail systems**  
**Systèmes de rails**  
**Laufschienensysteme**  
**Sistemas de rieles**  
**Sistemi di rotaie**

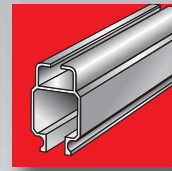

**4** End stops and splice bolt kit  
 Butées et raccords de rails  
 Endanschläge und Verbindungssätze  
 Tope final y uniones  
 Fine corsa e raccordi per rotaie

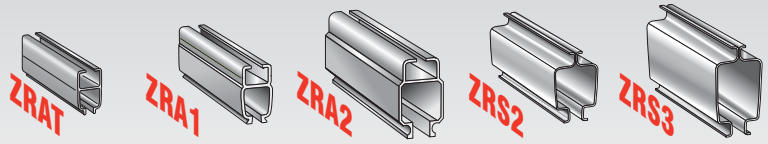

End stop Butée de fin de rail Endanschlag Tope final Fine corsa per rotaie		Ref. 31022	Ref. 30275	Ref. 30183	Ref. 30804	Ref. 30808
Redundant Butée additionnelle (redondante) Zusätzlicher Anschlag Redundante Respingente		Ref. 31024	Ref. 30277	Ref. 30185	Ref. 30806	Ref. 30810
Adjustable end stop Butée réglable Einstellbarer Anschlag Tope final ajustable Fine corsa e respingente regolabile		Ref. 30738	Ref. 30738	Ref. 30733	Ref. 30733	Ref. 30733
Splice bolt kit Kit de raccordement Verbindungssatz Uniones Kit di raccordo		Ref. 31020	Ref. 30231	Ref. 30057	Ref. 30515	Ref. 30515

**5** Air supply  
 Alimentations d'air  
 Luftversorgungssätze  
 Suministro de aire  
 Alimentazione aria

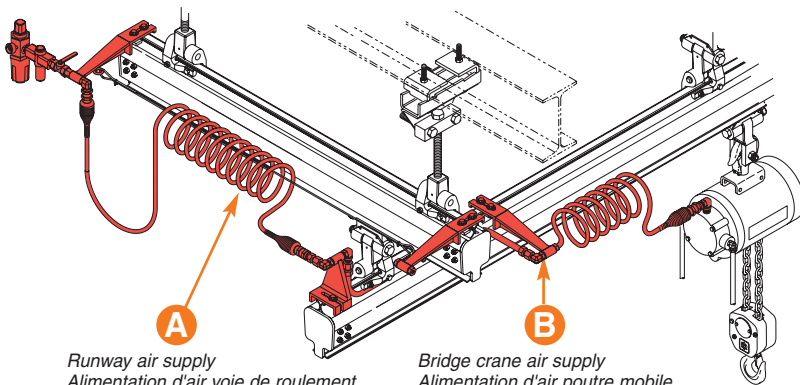

**A** Runway air supply  
 Alimentation d'air voie de roulement  
 Luftversorgungssatz Laufschiene  
 Suministro de aire de viga carril  
 Alimentazione aria piano rotaia

**B** Bridge crane air supply  
 Alimentation d'air poutre mobile  
 Luftversorgungssatz Brücke  
 Suministro de aire de viga puente  
 Alimentazione aria carro ponte

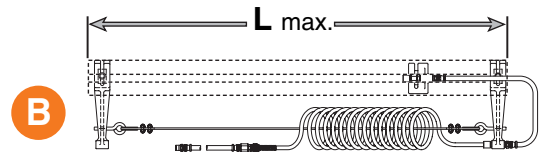

Ø 3/8"	Ref.	Ø 1/2"	Ref.
L = 9 m	ZHS90025	L = 9 m	ZHS90026

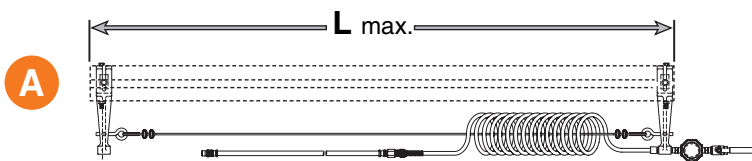
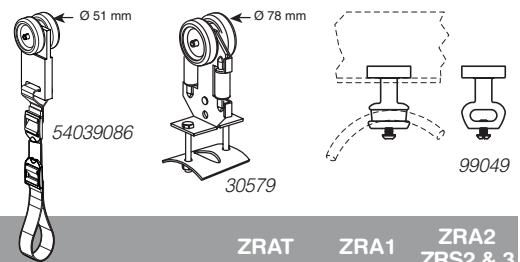

Ø 3/8"	Ref.	Ø 1/2"	Ref.
L = 15 m	90000-1	L = 15 m	90001-1
L = 22.5 m	90000-2	L = 22.5 m	90001-2
L = 30 m	90000-3	L = 30 m	90001-3
L = 37.5 m	90000-4	L = 37.5 m	90001-4
L = 45 m	90000-5	L = 45 m	90001-5

	ZRAT	ZRA1	ZRA2 ZRS2 & 3
<b>ELECTRIC</b>			
Festoon trolley Chariot porte-guirlande Girlandenwagen Carro portamangueras Carrelli portacavo	—	54039086	54039078
Slider Glisseur porte-guirlande Girlandengleiter Deslizador Cursore	99048	99048	99049
<b>PNEUMATIC &amp; ELECTRIC</b>			
Festoon trolley Chariot porte-guirlande Girlandenwagen Carro portamangueras Carrelli portacavo	31005 + 31011	30579	30581

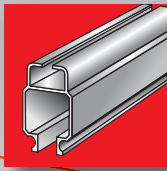

**Rail systems kits**  
**Kits de rails prêts à monter**  
**Schienensystempakete**  
**Conjuntos de rail**  
**Kit rotaie**

**Standard  
Equipment**

Hanger kits

Runways

End trucks

Bridge

End stops

Safety cables

Suspenseurs

Voies de roulement

Chariots supports  
de poutre mobile

Poutre mobile

Butées de rail

Câbles de sécurité

Aufhängegesätze

Laufschiene

Brückenfahrwagen

Brücke

Endanschläge

Sicherheitskabel

Suspensiones

Vigas carriles

Suspensiones  
del puente

Viga puente

Tope final

Cables de seguridad

Kits di sospensione  
su travi

Piano rotaia

Sospensioni  
per ponte mobile

Ponte

Fine corsa per rotaie

Cavi di sicurezza

End trucks  
Chariots supports de poutres mobiles  
Brückenfahrwagen  
Suspensiones del puente  
Carrello supporto rotaia mobile

Safety cables  
Câbles de sécurité  
Sicherheitskabel  
Cables de seguridad  
Cavi di sicurezza





Adjustable hanger kits  
Suspensions ajustables sous fers porteurs  
Einstellbare Aufhängungen  
Kits di sospensione ajustables  
Kit di sospensione regolabile

End stops  
Butées de fin de rail  
Endanschläge  
Tope final  
Fine corsa per rotaie

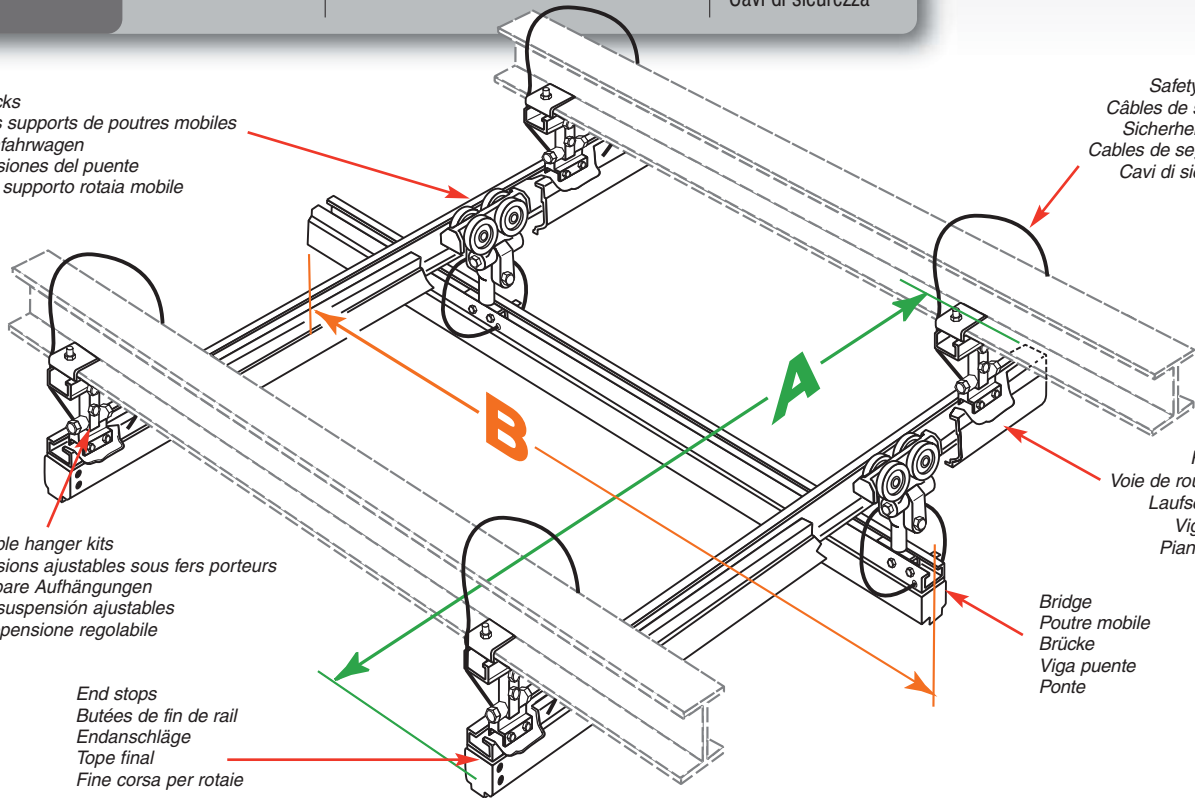
Runway  
Voie de roulement  
Laufschiene  
Viga carril  
Piano rotaia

Bridge  
Poutre mobile  
Brücke  
Viga puente  
Ponte



Ref.				
SR30A1B30SA1C220	ZRA1	3 m	3 m	220 Kg
SR40A1B30SA1C220	ZRA1	4 m	3 m	220 Kg
SR40A1B40SA1C180	ZRA1	4 m	4 m	180 Kg
SR50A1B30SA1C220	ZRA1	5 m	3 m	220 Kg
SR50A1B40SA1C180	ZRA1	5 m	4 m	180 Kg
SR50A1B50SA1C110	ZRA1	5 m	5 m	110 Kg
SR60A1B30SA1C220	ZRA1	6 m	3 m	220 Kg
SR60A1B40SA1C180	ZRA1	6 m	4 m	180 Kg
SR60A1B50SA1C110	ZRA1	6 m	5 m	110 Kg
SR50A2B30SA2C450	ZRA2	5 m	3 m	450 Kg
SR50A2B40SA2C450	ZRA2	5 m	4 m	450 Kg
SR60A2B30SA2C450	ZRA2	6 m	3 m	450 Kg
SR60A2B40SA2C450	ZRA2	6 m	4 m	450 Kg
SR60A2B50SA2C450	ZRA2	6 m	5 m	450 Kg
SR60A2B60SA2C300	ZRA2	6 m	6 m	300 Kg
SR90A2B30SA2C450	ZRA2	9 m	3 m	450 Kg
SR90A2B40SA2C450	ZRA2	9 m	4 m	450 Kg
SR90A2B60SA2C300	ZRA2	9 m	6 m	300 Kg

Spring Balancers  
Equilibreurs à Ressort  
Federzüge  
Equilibradores  
Bilanciatori

**B**  
Series



Cable balancers  
Equilibreurs à câble  
Kabel-Federzüge  
Equilibradores de cable  
Bilanciatori a fune

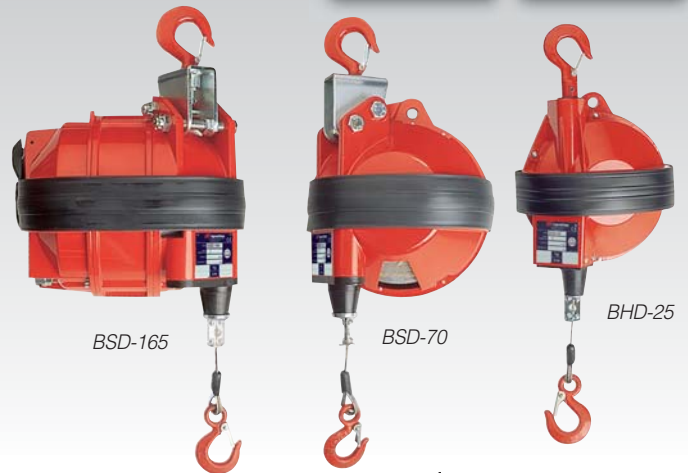
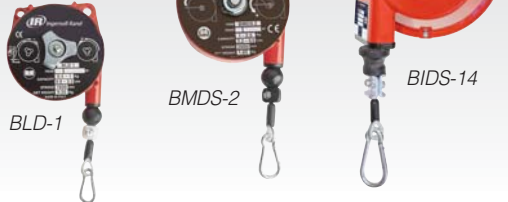

Ref.	SWL kg	m	kg
<b>BLD SERIES — SÉRIE BLD — BAUREIHE BLD — SERIE BLD</b>			
BLD-1	0.4 - 1.0	1.60	0.6
BLD-2	1.0 - 2.0	1.60	0.6
BLD-3	2.0 - 3.0	1.60	0.7
<b>BMD SERIES — SÉRIE BMD — BAUREIHE BMD — SERIE BMD</b>			
BMDS-2	1.0 - 2.5	2.0	2.0
BMDS-4	2.0 - 4.0	2.0	2.0
BMDL-4	2.0 - 4.0	2.5	2.9
BMDS-6	4.0 - 6.0	2.0	2.3
BMDL-6	4.0 - 6.0	2.5	3.2
BMDS-8	6.0 - 8.0	2.0	2.5
BMDL-8	6.0 - 8.0	2.5	3.5
BMDL-10	8.0 - 10	2.5	3.5
BMDL-12	10 - 14	2.5	4.0
BMDLL-4 <sup>(1)</sup>	2.0 - 4.0	2.5	3.0
BMDLL-6 <sup>(1)</sup>	4.0 - 6.0	2.5	3.3
BMDLL-8 <sup>(1)</sup>	6.0 - 8.0	2.5	3.6
BMDLL-10 <sup>(1)</sup>	8.0 - 10	2.5	3.8
<b>BIDS SERIES — SÉRIE BIDS — BAUREIHE BIDS — SERIE BIDS</b>			
BIDS-7	4.0 - 7.0	2.0	5.0
BIDS-10	7.0 - 10	2.0	5.5
BIDS-14	10 - 14	2.0	5.5
BIDS-18	14 - 18	2.0	6.5
BIDS-22	18 - 22	2.0	6.0
BIDS-26	22 - 25	2.0	6.6

- (1) Locking type balancer  
(1) Equilibreur avec arrêt de sécurité  
(1) Federzüge mit Arretierung  
(1) Equilibradores con dispositivo de bloqueo  
(1) Bilanciatori con dispositivo bloccaggio

Ref.	SWL kg	m	kg
<b>BHD SERIES — SÉRIE BHD — BAUREIHE BHD — SERIE BHD</b>			
BHD-15	10 - 15	2.0	10.3
BHD-20	15 - 20	2.0	10.6
BHD-25	20 - 25	2.0	11.2
BHD-30	25 - 30	2.0	11.5
BHD-35	30 - 35	2.0	11.8
BHD-45	35 - 45	2.0	12.4
BHD-55	45 - 55	2.0	12.5
BHD-65	55 - 65	2.0	13.6
<b>BSD SERIES — SÉRIE BSD — BAUREIHE BSD — SERIE BSD</b>			
BSD-20	15 - 20	2.5	19.0
BSDL-20	15 - 20	3.0	19.1
BSDL-25	20 - 25	3.0	19.9
BSD-30	20 - 30	2.5	19.8
BSDL-35	25 - 35	3.0	20.9
BSD-40	30 - 40	2.5	20.8
BSDL-45	35 - 45	3.0	23.8
BSD-50	40 - 50	2.5	23.9
BSDL-50	40 - 50	3.0	23.9
BSD-60	50 - 60	2.5	25.4
BSDL-60	50 - 60	3.0	25.3
BSD-70	60 - 70	2.5	26.8
BSDL-70	60 - 70	3.0	26.7
BSD-80	70 - 80	2.5	27.8
BSDL-80	70 - 80	3.0	28.0
BSD-90	80 - 90	2.5	28.8
BSDL-90	80 - 90	3.0	29.0
BSD-100	90 - 100	2.5	35.6
BSDL-100	90 - 100	3.0	36.8
BSDL-115	110 - 115	3.0	38.7
BSD-120	100 - 120	2.5	38.7
BSDL-130	115 - 130	3.0	39.9
BSD-140	120 - 140	2.5	41.8
BSDL-140	130 - 140	3.0	42.8
BSD-150	130 - 150	2.5	44.5
BSDL-150	140 - 150	3.0	45.6
BSD-165	150 - 165	2.5	48.2

Ref. No. : **OPTRI**

For swivel bottom hook (BHD, BSD and BSDL Series, up to 180 kg capacity)

Pour la rotation du crochet bas (séries BHD, BSD et BSDL jusque 180 kg)

Für drehbaren unteren Haken (Baureihen BHD, BSD und BSDL) bis zu 180 kg Last

Para gancho de la carga giratorio (Series BHD, BSD y BSDL, hasta 180 kg de capacidad)

Per la rotazione del gancio inferiore (serie BHD, BSD e BSDL, capacità < 180 Kg)

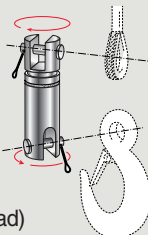

Ref. No. **BHR-8** : 0.4 - 0.8 kg  
Ref. No. **BHR-15** : 0.7 - 1.5 kg  
Ref. No. **BHR-25** : 1.2 - 2.5 kg

1/4" Hose reel balancers - Lift 1.30 m  
Equilibreurs à enrouleur 1/4" - Levée 1.30 m  
1/4" Schlauch-Federzüge - Hubhöhe 1,30 m  
Equilibradores de manguera de 1/4" - Corsa 1,30 m  
Bilanciatori con tubo alim. 1/4" - Corsa 1,30 m



12



# BW Series

## Pneumatic Balancers Equilibreurs Pneumatiques Druckluft-Balancer Posicionadores de Cargas Neumáticos Posizionatori di Carico Pneumatici



**1 "BW"**  
Basic unit,  
without control  
Unité sans  
commande  
Balancer ohne  
Steuerelemente  
Posicionador sin  
control  
Posizionatore senza  
comando

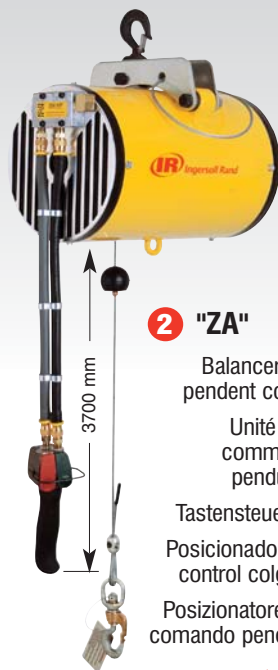

**2 "ZA"**  
Balancer with  
pendent control  
Unité avec  
commande  
pendulaire  
Tastensteuerung  
Posicionador con  
control colgante  
Posizionatore con  
comando pendente

Recommended  
working load capacity:  
10 to 80 % of SWL



**3 "BA"**  
Balancer with  
Servo control  
Unité avec  
équilibrage simple et  
servomécanisme  
Einheitslaststeuerung  
mit Servo  
Control único de  
equilibrio con  
servomecanismo  
Comando a singolo  
bilanciamento, con  
servo-valvola

Recommended working load capacity: 10 to 60 % of SWL

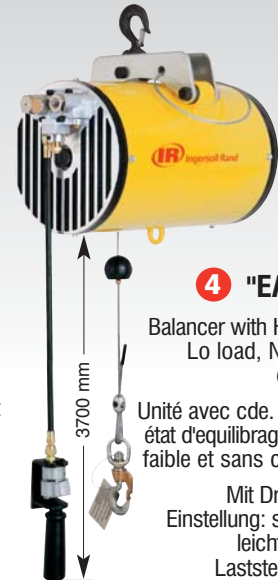

**4 "EA"**  
Balancer with Hi load,  
Lo load, No load  
control  
Unité avec cde. à triple  
état d'équilibrage (fort,  
faible et sans charge)  
Mit Dreifach-  
Einstellung: schwer,  
leicht, keine  
Laststeuerung  
Control de alta,  
baja y sin carga  
Comando alto,  
basso, nessun  
carico

Ref. no. <b>1</b>	Ref. no. <b>2</b>	Ref. no. <b>3</b>	Ref. no. <b>4</b>	SWL @ 500 kPa kg	SWL @ 600 kPa kg	SWL @ 700 kPa kg	Hook m	Ø mm	Weight kg
<b>SINGLE WIRE ROPE — UNITÉS SIMPLES — EINSTRÄNGIGE SEILAUSFÜHRUNG — UNA RAMALE — FUNE SINGOLO RINVIO</b>									
BW015080 <sup>(1)</sup>	ZAW015080 <sup>(1)</sup>	BAW015080 <sup>(1)</sup>	EAW015080 <sup>(1)</sup>	49	58	68	2.0	165	23
BW020120	ZAW020120	BAW020120	EAW020120	65	78	90	3.0	254	28
BW020120S <sup>(2)</sup>	ZAW020120S <sup>(2)</sup>	BAW020120S <sup>(2)</sup>	EAW020120S <sup>(2)</sup>	65	78	90	3.0	254	28
BW032080S <sup>(2)</sup>	ZAW032080S <sup>(2)</sup>	BAW032080S <sup>(2)</sup>	EAW032080S <sup>(2)</sup>	104	124	145	2.0	254	28
BW035080 <sup>(1)</sup>	ZAW035080 <sup>(1)</sup>	BAW035080 <sup>(1)</sup>	EAW035080 <sup>(1)</sup>	113	136	160	2.0	254	28
BW050080	ZAW050080	BAW050080	EAW050080	162	194	225	2.0	254	50
BW050080S <sup>(2)</sup>	ZAW050080S <sup>(2)</sup>	BAW050080S <sup>(2)</sup>	EAW050080S <sup>(2)</sup>	162	194	225	2.0	254	50
<b>REEVED WIRE ROPE — UNITÉS MOUFLÉES — ZWEISTRÄNGIGE SEILAUSFÜHRUNG — CON VUELTA — FUNE DOPPIO RINVIO</b>									
BW040060	ZAW040060	BAW040060	EAW040060	130	155	180	1.5	254	30
BW040060S <sup>(2)</sup>	ZAW040060S <sup>(2)</sup>	BAW040060S <sup>(2)</sup>	EAW040060S <sup>(2)</sup>	130	155	180	1.5	254	30
BW065040S <sup>(2)</sup>	ZAW065040S <sup>(2)</sup>	BAW065040S <sup>(2)</sup>	EAW065040S <sup>(2)</sup>	208	248	290	1.0	254	30
BW070040 <sup>(1)</sup>	ZAW070040 <sup>(1)</sup>	BAW070040 <sup>(1)</sup>	EAW070040 <sup>(1)</sup>	226	272	320	1.0	254	30
BW100040	ZAW100040	BAW100040	EAW100040	324	388	450	1.0	254	52
BW100040S <sup>(2)</sup>	ZAW100040S <sup>(2)</sup>	BAW100040S <sup>(2)</sup>	EAW100040S <sup>(2)</sup>	324	388	450	1.0	254	52
<b>TANDEM WIRE ROPE — UNITÉS EN TANDEM — TANDEM SEILAUSFÜHRUNG — UNIDADES EN TANDEM — TANDEM FUNE SINGOLO RINVIO</b>									
BW040120	ZAW040120	BAW040120	EAW040120	130	155	180	3.0	254	56
BW040120S	ZAW040120S	BAW040120S	EAW040120S	130	155	180	3.0	254	56
BW065080S	ZAW065080S	BAW065080S	EAW065080S	208	248	290	2.0	254	56
BW070080 <sup>(1)</sup>	ZAW070080 <sup>(1)</sup>	BAW070080 <sup>(1)</sup>	EAW070080 <sup>(1)</sup>	226	272	320	2.0	254	56
BW100080	ZAW100080	BAW100080	EAW100080	324	388	450	2.0	254	100
BW100080S	ZAW100080S	BAW100080S	EAW100080S	324	388	450	2.0	254	100

(1) Not available with Z-Stop safety device  
(1) Non disponible avec dispositif anti-dérive Z-Stop  
(1) Nicht erhältlich mit Z-Stop Hochschnellschutz  
(1) No disponible con dispositivo de fijación Z-Stop  
(1) Non disponibile con Arresto in discesa "Z-Stop"

(2) Model delivered with Z-Stop as standard.  
(2) Modèle équipé du dispositif Z-Stop en standard.  
(2) Modell standardmäßig mit Z-Stop.  
(2) Modelo estándar suministrado con parada Z-stop.  
(2) Modelli forniti con Z-Stop come standard

Pneumatic Balancers  
 Equilibrés Pneumatiques  
 Druckluft-Balancer  
 Posizionadores de Cargas Neumáticos  
 Posizionatori di Carico Pneumatici

**BW Series**

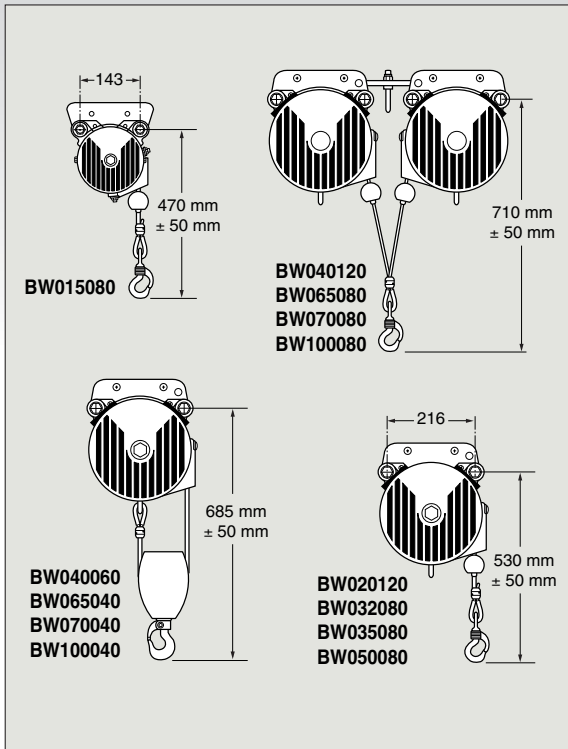

Suspension  
 Aufhängung  
 Suspensión  
 Sospensione

S2, S3, AT, A1, A2



**HM**  
 Hook mount  
 Crochet  
 Hakenaufhängung  
 Montaje en gancho  
 Montaggio su gancio



**TR**  
 T-Rail / I-Beam  
 Rail T / Poutre I  
 T-Schiene / Doppel-T-Träger  
 Carril T / Viga I  
 Rotaia a T / Trave I

Only for 50 mm  
 66 mm, 82 mm  
 & 100 mm

Model identification codes  
 Codification des références  
 Modellbezeichnungen  
 Códigos de identificación de los modelos  
 Codici identificazione modello

Example • Exemple • Beispiel • Ejemplo • Esempio :

**ZAW065040SS3**

Part numbers for  
**BW15080**  
 (Ø 165 mm)



Part numbers for  
 Ø 254 mm units



CONTROL — COMMANDE — STEUERUNG — CONTROL — COMANDO						
<b>B</b>	Basic - No control	Nu, sans commande	Ohne Steuerung	Sin control	Nessun comando	— —
<b>ZA</b>	Pendent control	Cde. pendulaire	Tastensteuerung	Mando por pulsadores	Comando pendente	15300-12 15300-12
<b>BA</b>	Single balance control	Equil. simple + servo	Einheitslaststeuerung	Control único equilibrio	Comando singolo bil.	15320 15330
<b>EA</b>	Hi, low, no load control	Cde. triple à état	Dreifach-Einstellung	Alta, baja, y sin carga	Alto, bas. senza contr. carico	15310-12 15310-12
SUSPENSION — SUSPENSION — AUFHÄNGUNG — SUSPENSIÓN — SOSPENSIONE (tandem units require 2 suspension kit)						
<b>00</b>	No suspension	Sans suspension	Keine	Sin suspensión	Nessuna Sospensione	— —
<b>S2</b>	IR ZRS2 steel rail	Rail acier ZRS2 IR	IR ZRS2 (Stahl)	IR ZRS2 (acero)	IR ZRS2 (acciaio)	16300 16400
<b>S3</b>	IR ZRS3 steel rail	Rail acier ZRS3 IR	IR ZRS3 (Stahl)	IR ZRS3 (acero)	IR ZRS3 (acciaio)	16300 16400
<b>HM</b>	Hook mount	Crochet	Hakenaufhängung	Gancho de suspensión	Montaggio su gancio	16360 16460
<b>TR (1)</b>	T-Rail / I-Beam	Rail T / Poutre I	T-Schiene / Doppel-T	Carril T / Viga I	Rotaia a T / Trave I	16320 16420
<b>AT</b>	IR ZRAT alu. rail	Rail alu. ZRAT IR	IR ZRAT (aluminium)	IR ZRAT (aluminium)	IR ZRAT (aluminium)	16355 16455
<b>A1</b>	IR ZRA1 alu. rail	Rail alu. ZRA1 IR	IR ZRA1 (aluminium)	IR ZRA1 (aluminium)	IR ZRA1 (aluminium)	16305 16405
<b>A2</b>	IR ZRA2 alu. rail	Rail alu. ZRA2 IR	IR ZRA2 (aluminium)	IR ZRA2 (aluminium)	IR ZRA2 (aluminium)	16310 16410
<b>K1</b>	KBK1 (Demag)	KBK1 (Demag)	KBK1 (Demag)	KBK1 (Demag)	KBK1 (Demag)	16325 16425
<b>K2</b>	KBK2 (Demag)	KBK2 (Demag)	KBK2 (Demag)	KBK2 (Demag)	KBK2 (Demag)	16315 16415

(1) Only for 50, 66, 82 and 100 mm rail widths.

(1) Adaptable sur fer de roulement de 50, 66, 82 et 100 mm de large.

(1) Nur für Trägerbreiten von 50, 66, 82 und 100 mm.

(1) Sólo para ancho de rail de 50, 66, 82 y 100 mm.

(1) Solo per rotaie con larghezza 50, 66, 82 e 100 mm.



**BW  
Series**

**Pneumatic Balancers  
Équilibreur Pneumatiques  
Druckluft-Balancer  
Posicionadores de Cargas Neumáticos  
Posizionatori di Carico Pneumatici**



### Options

Ref. **58267352**

**SPEED CONTROL KIT:** Regulates the inlet pressure of the balancer – Full control of lifting speed for any loads – Must be used with the ZA pendent control 15300.

**KIT DE CONTROLE DE VITESSE:** Regule la pression interne de l'équilibreur – Contrôle parfait de la vitesse de montée pour différentes charges – Doit être utilisé avec une commande ZA 15300.

**GESCHWINDIGKEITS-REGELVENTIL:** Das Geschwindigkeits-Regelventil stabilisiert die Hubgeschwindigkeit bei großen Gewichtsunterschieden zwischen Vollast und ohne Belastung. Es wird mit einer ZA15300 Steuerung kombiniert und ist als Zubehör verfügbar.

**KIT DE CONTROL DE VELOCIDAD:** Regula la presión internal del posicionador – Mejor control de la velocidad de subida con diferentes cargas – Se debe utilizar con el mando de control ZA 15300.

**KIT CONTROLLO VELOCITA':** regola la pressione d' ingresso del bilanciatore. Controllo completo della velocità di sollevamento per qualsiasi carico. Deve essere usato con lo ZA 15300 controllo pendente.



Ref.  
**15300-TC-NH**



Ref.  
**15300-TC-I-NH**

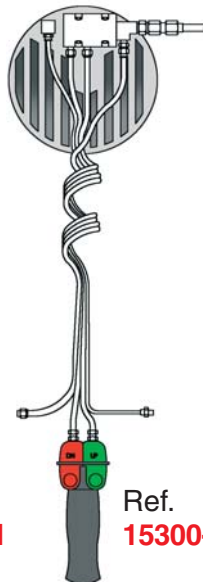

Ref.  
**15300-QC-NH**



Ref.  
**15300-QC-I-NH**

#### TRI-COIL

Specially designed to integrate a mechanical handling device with an up and down control.

Spécialement étudié pour l'intégration d'un préhenseur mécanique, avec une commande montée / descente.

Dreifache Spiralschlauchsatz mit ZA Steuerung, für die Intigrierung in eine mechanische Vorrichtung.

Especialmente diseñado para la integración de un utillaje mecánico con un mando de control para subir y bajar.

Specificatamente studiato per l'integrazione un dispositivo meccanico di azionamento con un controllo salita/discesa.

#### TRI-COIL + Interlock

Specially designed to integrate a simple handling device – Incorporates the Interlock safety device.

Spécialement étudié pour l'intégration d'un préhenseur mécanique, avec une commande montée / descente – Livré avec interlock.

Dreifache Spiralschlauchsatz mit Interlockventil und ZA für die Intigrierung in eine Vorrichtung.

Especialmente diseñado para la integración de un manipulador, incluyendo el interlock.

Specificatamente studiato per l'integrazione di un semplice dispositivo di azionamento. Incorpora il dispositivo di sicurezza Interlock

#### QUAD-COIL

Specially designed to integrate a pneumatic powered handling device (3rd air supply tube).

Spécialement étudié pour l'integration d'un préhenseur pneumatique (3ème flexible pour l'alimentation en air)

Vierfache Spiralschlauchsatz mit ZA und Luftzuführ-Spiralschlauch, für die Intigrierung in eine pneumatische Vorrichtung.

Especialmente diseñado para la integración de un utillaje neumático (3 mangueras flexibles para la alimentación de aire)

Specificatamente studiato per l'integrazione un dispositivo pneumatico di azionamento con un comando di controllo (terzo tubo di alimentazione)

#### QUAD-COIL + Interlock

Specially designed to integrate a pneumatic powered handling device (3rd air supply tube) – Incorporates the Interlock safety device.

Spécialement étudié pour l'integration d'un préhenseur pneumatique (3ème flexible pour l'alimentation en air) – Livré avec interlock.

Vierfache Spiralschlauchsatz mit ZA, Interlockventil und Luftzuführ-Spiralschlauch für die Intigrierung in eine pneumatische Vorrichtung.

Especialmente diseñado para la integración de un utillaje neumático (3 mangueras flexibles para la alimentación de aire) incluyendo el interlock.

Specificatamente studiato per l'integrazione un dispositivo pneumatico di azionamento con un comando di controllo (terzo tubo di alimentazione). Incorpora il dispositivo di sicurezza Interlock.



## Magic Stick

### New sensitive inline handle for faster and smoother applications:

- 100% pneumatic system with fully sensitive "up and down" control.
- Move the load without any push button.
- Proportional speed (the more you pull the handle, the faster the load goes).
- Load remains balanced on the whole stroke of the balancer.

### Nouvelle poignée sensitive en ligne pour des applications plus rapides et plus souples :

- Système 100% pneumatique avec controle montée / descente sensitif.
- Déplacez votre charge sans aucun bouton.
- Vitesse proportionnelle (plus l'effort sur la poignée est important, plus la vitesse est grande).
- La charge reste équilibrée sur toute la course de l'équilibreur.

### Neuer empfindliche Handgriff-Steuerung für schnellere, genauere und weichere Bewegungen:

- 100% pneumatisches System mit stufenlose Auf- und Ab-Erkennung.
- Bewegen der Last ohne zusätzliche Schalter und Druckknöpfe.
- Proportionale Geschwindigkeitsreglung (je stärker der Handgriff bewegt wird, um so schneller bewegt sich die Last).
- Last bleibt über den gesamten Hubbereich ausgeglichen.

### Nuevo mando sensible incorporado para aplicaciones con mayor velocidad y suavidad de movimiento:

- Sistema 100% neumático con control vertical totalmente sensitivo.
- Movimiento de la carga sin pulsar ningún botón.
- Velocidad proporcional (a mayor presión sobre el mando, mayor velocidad de la carga).
- La carga permanece ingravida durante todo el recorrido del equilibrador.

### Nuova maniglia lineare sensibile (per una applicazione agevole e più veloce):

- 100% sistema pneumatico con controllo su e giù estremamente sensibile.
- Spostamento del carico senza alcun pulsante.
- Velocità proporzionale (più tiri la maniglia più velocemente si sposta il carico).
- Il carico resta bilanciato sull'intero "braccio del balancer".

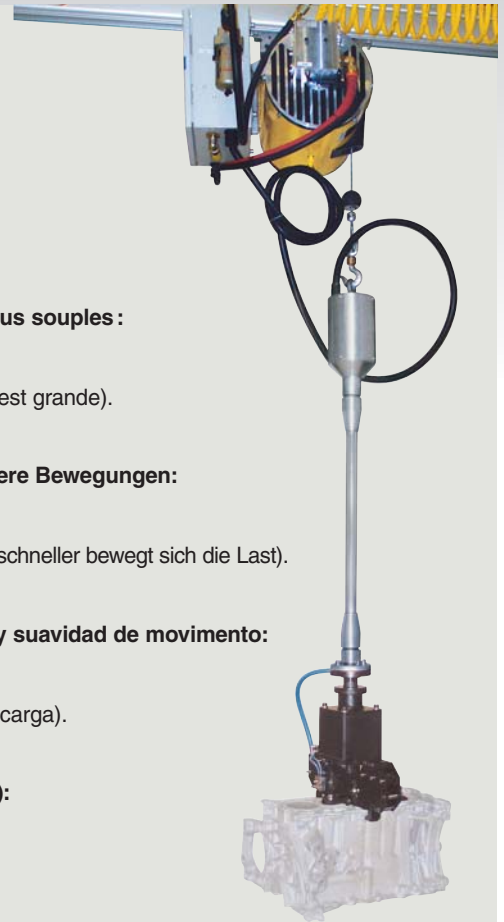

### 0.9 - 22 kg Air Positioner Equilibreur Pneumatique 0,9 à 22 kg 0,9 - 22 kg Druckluft-Positionierer Posicionador neumático 0,9 - 22 kg Posizionatore ad aria 0,9 - 22 kg

Air positioner including our exclusive floating feature. Wide range of balancing capacities from 0.9 to 22 kg. Simple adjustment by means of external regulator. Low headroom with 510 mm.

Equilibreur pneumatique à effet "coussin d'air". Très large plage de réglages, de 0,9 à 22 kg. Réglage rapide par molette extérieure. Hauteur perdue 51 cm.

Druckluft-Positionierer verfügt über exklusive gleitende Eigenschaft. Großer Arbeitsbereich der zu positionierenden Kapazität von 0,9 bis 22,0 kg. Schnelle Justage über ein externes Ventil. Geringer Raumbedarf von nur 510 mm.

Posicionador de carga neumático con recorrido de flotación. Ajuste desde 0.9 Kg hasta 22 Kg. Altura perdida: 51 cm.

Posizionatore ad aria che include il nostro esclusivo gioco assiale. Ampia gamma di capacità di bilanciatura da 0,9 a 22 Kg. Facilmente modificabile attraverso regolatore esterno. Basso profilo 510 mm.



BAW005060

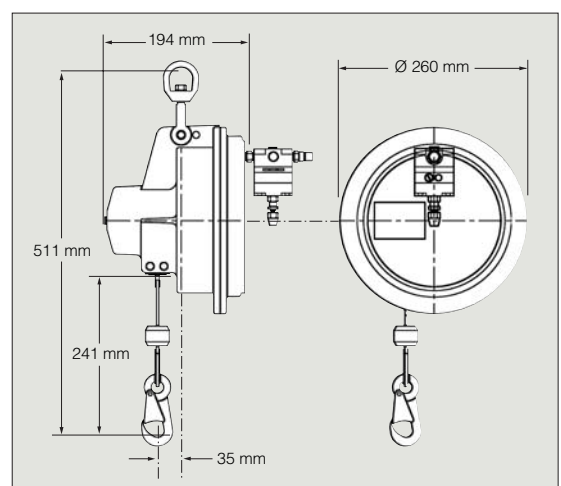

Ref. no.	SWL @ 700 kPa kg	Stroke m	Ø mm	Height kg
BAW005060	0.9-22	1.5	260	9.0



**Intelift  
Series**

**Pneumatic Balancers  
Equilibreurs Pneumatiques  
Druckluft-Balancer  
Posicionadores de Cargas Neumáticos  
Posizionatori di Carico Pneumatici**



IBW015080

### Intelift Control Options

- IB** = Intelift Basic, no controls (Controls are required to operate the unit)
- IA** = Intelift Pendant control handle with 3 m twin bonded pre-coil cable
- IC** = Intelift Force Sensing control handle with 3 m twin bonded pre-coil cable
- IS** = Intelift Pendant control handle with 3 m straight electric cable

### Options de commande Intelift

- IB** = Unité de base Intelift, sans commande
- IA** = Intelift avec poignée de commande pendulaire et 3 m de câble spiralé double
- IC** = Intelift avec poignée de commande sensitive et 3 m de câble spiralé double
- IS** = Intelift avec poignée de cde. pendulaire et 3 m de câble électrique droit

### Intelift Steueroptionen

- IB** = Intelift, Basis, keine Steuerungen
- IA** = Intelift, hängender Steuerhandgriff mit 3 m spiralförmigem Zweileiterkabel
- IC** = Intelift, Lastmeß-Steuerhandgriff mit 3 m spiralförmigem Zweileiterkabel
- IS** = Intelift, hängender Steuerhandgriff mit 3 m geradem Stromkabel

### Opciones de control Intelift

- IB** = Intelift Básico, sin controles (se requieren controles para operar la unidad)
- IA** = Intelift con mando de pulsadores y 3 m de cable espiral doble
- IC** = Intelift con mando por sensor de esfuerzo y 3 m de cable espiral doble
- IS** = Intelift con mando de pulsadores y 3 m de cable recto

### Opzioni di controllo Intelift

- IB** = Intelift modello base, senza comando
- IA** = Intelift con comando a pulsantiera e 3 m di cavo a doppia spirale
- IC** = Intelift con comando a pulsantiera sensitiva e 3 m di tubo a doppia spirale
- IS** = Intelift con comando a pulsantiera con 3 m di cavo elettrico dritto

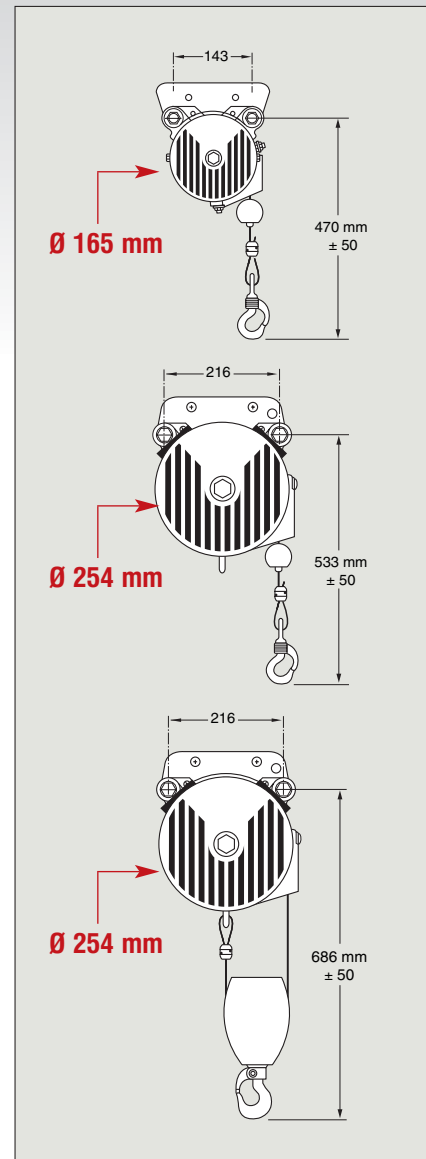

Ref. no. <b>IB</b>	Ref. no. <b>IA</b>	Ref. no. <b>IC</b>	Ref. no. <b>IS</b>	SWL @ 500 kPa kg	SWL @ 600 kPa kg	SWL @ 700 kPa kg	m	mm	kg
<b>SINGLE WIRE ROPE UNITS — UNITÉS SIMPLES — EINSTRÄNGIGE SEILAUSFÜHRUNG — UNIDADES DE CABLE DE UNA RAMALE — FUNE SINGOLO RINVIO</b>									
IBW015080 <sup>(1)</sup>	IAW015080 <sup>(1)</sup>	ICW015080 <sup>(1)</sup>	ISW015080 <sup>(1)</sup>	49	58	68	2.0	165	27
IBW020120	IAW020120	ICW020120	ISW020120	65	78	91	3.0	254	33
IBW033080	IAW033080	ICW033080	ISW033080	107	128	150	2.0	254	33
IBW050080	IAW050080	ICW050080	ISW050080	162	194	227	2.0	254	54
<b>REEVED WIRE ROPE UNITS — UNITÉS MOUFLÉES — ZWEISTRÄNGIGE SEILAUSFÜHRUNG — UNIDADES DE CABLE CON VUELTA — FUNE DOPPIO RINVIO</b>									
IBW040060	IAW040060	ICW040060	ISW040060	130	156	182	1524	254	30
IBW066040	IAW066040	ICW066040	ISW066040	114	256	300	1016	254	35
IBW100040	IAW100040	ICW100040	ISW100040	324	388	454	1016	254	57

(1) Not available with Z Stop option  
 (1) Non disponible avec option Z Stop  
 (1) Nicht erhältlich mit Option Z-Stop  
 (1) No disponible con la opción Z-Stop  
 (1) Non disponibile con opzione arresto Z



Pneumatic Balancers  
 Equilibreurs Pneumatiques  
 Druckluft-Balancer  
 Posicionadores de Cargas Neumáticos  
 Posizionatori di Carico Pneumatici

**Intelift  
 Series**



Model identification codes  
 Codification des références  
 Modellbezeichnungen  
 Códigos de identificación de los modelos  
 Codici identificazione modello

Example • Exemple • Beispiel • Ejemplo • Esempio :

**IAW020120 A2 2 S**

SUSPENSION — SUSPENSION — AUFHÄNGUNG — SUSPENSIÓN — SOSPENSIONE					
00	No suspension	Sans suspension	Keine	Sin suspensión	Nessuna Sospensione
S2	IR ZRS2 steel rail	Rail acier ZRS2 IR	IR ZRS2 (Stahl)	IR ZRS2 (acciaio)	IR ZRS2 (acciaio)
S3	IR ZRS3 steel rail	Rail acier ZRS3 IR	IR ZRS3 (Stahl)	IR ZRS3 (acciaio)	IR ZRS3 (acciaio)
HM	Hook mount	Crochet	Hakenaufhängung	Gancho de suspensión	Montaggio su gancio
TR (1)	T-Rail / I-Beam	Rail T / Poutre I	T-Schiene / Doppel-T	Carril T / Viga I	Rotaia a T / Trave I
AT	IR ZRAT alu. rail	Rail alu. ZRAT IR	IR ZRAT (aluminium)	IR ZRAT (aluminium)	IR ZRAT (aluminium)
A1	IR ZRA1 alu. rail	Rail alu. ZRA1 IR	IR ZRA1 (aluminium)	IR ZRA1 (aluminium)	IR ZRA1 (aluminium)
A2	IR ZRA2 alu. rail	Rail alu. ZRA2 IR	IR ZRA2 (aluminium)	IR ZRA2 (aluminium)	IR ZRA2 (aluminium)
K1	KBK1 (Demag)	KBK1 (Demag)	KBK1 (Demag)	KBK1 (Demag)	KBK1 (Demag)
K2	KBK2 (Demag)	KBK2 (Demag)	KBK2 (Demag)	KBK2 (Demag)	KBK2 (Demag)
INPUT VOLTAGE — TENSION D'ALIMENTATION — EINGANGSSPANNUNG — TENSION ENTRADA — TENSIONE D'INGRESSO					
1	115V 50/60 Hz 1Ph	115V 50/60 Hz 1Ph	115V 50/60 Hz 1Ph	115V 50/60 Hz 1Ph	115V 50/60 Hz 1Ph
2	230V 50/60 Hz 1Ph.	230V 50/60 Hz 1Ph.	230V 50/60 Hz 1Ph.	230V 50/60 Hz 1Ph.	230V 50/60 Hz 1Ph.
Z-STOP					
0	None	Sans Z-Stop	Keine Z-Stop	Sin Z-Stop	Nessuna Z-Stop
S	Z-stop	Dispositif anti-dérive	Tiefenanschlag	Tope de bajada	Arresto in discesa

(1) Only for 50, 66, 82 and 100 mm rail widths — (1) Adaptable sur fer de roulement de 50, 66, 82 et 100 mm de large.  
 (1) Nur für Trägerbreiten von 50, 66, 82 und 100 mm — (1) Sólo para ancho de rail de 50, 66, 82 y 100 mm — (1) Solo per rotaie con larghezza 50, 66, 82 e 100 mm.



## Contact Information

Information de contact  
Información de contacto  
Informazioni di contatto

### UK & Ireland

Ingersoll Rand Industrial Technologies  
Swan Lane, Hindley Green  
Wigan WN2 4EZ,  
United Kingdom  
Tel: +44 1942 257171  
Fax: +44 1942 503451  
E-mail: [ingersollranduk@irco.com](mailto:ingersollranduk@irco.com)  
E-mail: [ingersollrandireland@irco.com](mailto:ingersollrandireland@irco.com)

### France & BeLux

Ingersoll Rand Industrial Technologies  
14, avenue Gustave Eiffel  
Diagonale Ouest  
78180 Montigny-le-Bretonneux  
France  
Tel: +33 1 30 07 69 60  
Fax: +33 1 30 07 69 80  
E-mail: [ingersollrandfrance@irco.com](mailto:ingersollrandfrance@irco.com)  
E-mail: [ingersollrandbelgium@irco.com](mailto:ingersollrandbelgium@irco.com)

### Netherlands

Ingersoll Rand Industrial Technologies  
Produktieweg 10  
2382 PB Zoeterwoude  
Netherlands  
Tel : +31 71 582 3456  
Fax : +31 71 582 3400  
E-mail: [info@ingersollrand.nl](mailto:info@ingersollrand.nl)

### Spain & Portugal

Ingersoll Rand Industrial Technologies  
C/ Tierra de Barros, 2 - Pol. Ind.  
28820 Coslada, Madrid  
Spain  
Tel: +34 91 627 7400  
Fax: +34 91 627 7401  
E-mail: [ingersollrandspain@irco.com](mailto:ingersollrandspain@irco.com)

### Italy, Greece & Turkey

Ingersoll Rand Industrial Technologies  
Strada Provinciale Cassanese 108  
20060 Vignate, Milano  
Italy  
Tel: +39 02 95 05 61  
Fax: +39 02 95 60 415  
E-mail: [ingersollranditaly@irco.com](mailto:ingersollranditaly@irco.com)

### Germany, Austria & Switzerland

Ingersoll Rand GmbH  
Industrial Technologies  
Max-Planck-Ring 27  
46049 Oberhausen  
Germany  
Tel: +49 208 9994 250  
Fax: +49 208 9994 252  
E-mail: [ingersollrandgermany@irco.com](mailto:ingersollrandgermany@irco.com)

### Scandinavia

Ingersoll Rand Industrial Technologies  
Krossverksgatan 5 L  
21616 Malmö  
Sweden  
Tel: +46 40 16 20 60  
Fax: +46 40 16 20 65  
E-mail: [ingersollrandscan@irco.com](mailto:ingersollrandscan@irco.com)

### Poland

Ingersoll Rand Industrial Technologies  
Kolejowa 5/7  
01-217 Warszawa  
Poland  
Tel: +48 22 434 7770  
Fax: +48 22 434 7701  
E-mail: [ingersollrandeasterneurope@irco.com](mailto:ingersollrandeasterneurope@irco.com)

### Czech Republic, Slovakia & Hungary

Ingersoll Rand Industrial Technologies  
Florianova 2460  
253 01 Hostivice  
Czech Republic  
Tel: +420 257 109 756  
Fax: +420 257 109 758  
E-mail: [ingersollrandeasterneurope@irco.com](mailto:ingersollrandeasterneurope@irco.com)

### Russia & C.I.S.

Ingersoll Rand Industrial Technologies  
5, 1st Derbenevskiy Lane  
Moscow 115114  
Russia  
Tel: +7 495 663 8267  
Fax: +7 495 785 2126  
E-mail: [ingersollrandcis@irco.com](mailto:ingersollrandcis@irco.com)

### Bulgaria, Romania, Slovenia, Croatia, Bosna-H., Serbia & Montenegro

Ingersoll Rand Industrial Technologies  
Florianova 2460  
253 01 Hostivice  
Czech Republic  
Tel: +420 257 109 756  
Fax: +420 257 109 758  
E-mail: [ingersollrandeasterneurope@irco.com](mailto:ingersollrandeasterneurope@irco.com)

### Estonia, Latvia & Lithuania

Ingersoll Rand Industrial Technologies  
Kolejowa 5/7  
01-217 Warszawa  
Poland  
Tel: +48 22 434 7770  
Fax: +48 22 434 7701  
E-mail: [ingersollrandeasterneurope@irco.com](mailto:ingersollrandeasterneurope@irco.com)

### Subsaharian Africa

Ingersoll Rand Industrial Technologies  
Michelle Ferrero Business Park  
21 Innes Road – Jet Park  
PO Box 14687, Witfield 1467  
South Africa  
Tel: +27 11 565 8600  
Fax: +27 11 565 8660  
E-mail: [ingersollrandsa@irco.com](mailto:ingersollrandsa@irco.com)

### Northern Africa

Ingersoll Rand Industrial Technologies  
14, avenue Gustave Eiffel  
Diagonale Ouest  
78180 Montigny-le-Bretonneux  
France  
Tel: +33 1 30 07 69 60  
Fax: +33 1 30 07 69 80  
E-mail: [ingersollrandfrance@irco.com](mailto:ingersollrandfrance@irco.com)

### Middle East

Ingersoll Rand Industrial Technologies  
7th Floor, Al Ghazal Complex  
Al Diyafah Street  
Dubai – P.O.Box 31000  
United Arab Emirates  
Tel: +971 4 346 0090  
Fax: +971 4 346 0087  
E-mail: [ingersollrandmea@irco.com](mailto:ingersollrandmea@irco.com)



Ingersoll Rand Industrial Technologies provides products, services and solutions that enhance our customers' energy efficiency, productivity and operations. Our diverse and innovative products range from complete compressed air systems, tools and pumps to material and fluid handling systems and environmentally friendly microturbines. We also enhance productivity through solutions created by Club Car®, the global leader in golf and utility vehicles for businesses and individuals.

[www.ingersollrandproducts.com](http://www.ingersollrandproducts.com)

*Distributed by :*

Nothing contained within this brochure is intended to extend any warranty or representation, expressed or implied, regarding the products described herein. Any such warranties or other items or conditions of sale of products shall be in accordance with Ingersoll Rand' s standard terms and conditions of sale for such products, which are available upon request. Product improvement is a continuing goal at Ingersoll Rand. Designs and specifications are subject to change without notice or obligation.