



# Accessories

Airline & Tool Accessories



Get the most out  
of your tools

# Airline Accessories

Featuring products for air preparation, including FRLs, hoses, couplings and plugs.

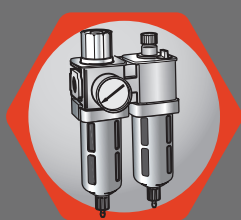

**3-11**

ARO-Flo Series  
Filters, Regulators,  
Lubricators

**12-13**

Super Duty Series  
Filters, Regulators,  
Lubricators

**14**

Special Airline  
Products

**15**

Fittings & Valves

**16-17**

Quick Release  
Couplings  
& Nipples

**18-19**

Hoses, Mufflers,  
Blow Guns



# ARO-Flo Series Air Filters, Regulators & Lubricators

## ARO-Flo Series

For more than 100 years, Ingersoll Rand has been an industry leader in the design and manufacture of compressors, pneumatic tools, and air preparation equipment.

Clean air is a key ingredient that enables effective and efficient operation of tools and machinery. The use of air preparation devices, such as filters, regulators and lubricators is an excellent way of keeping your tools and equipment to operate at their peak performance.

The new ARO-Flo Series continue the tradition of offering premium products for your operating.

### Performance

ARO-Flo Series FRLs set the standard for flow performance. Simply put, air flows better through ARO-Flo filters, regulators, and lubricators than almost any other air filtration device. This means more air is passed during the air preparation process, and your equipment can perform at its peak performance.

### Modularity

All ARO-Flo accessories are designed to integrate with each other within each size range. From pipe adapters to T-brackets, your complete FRL assembly and its individual components can be easily, safely, and quickly assembled or disassembled with a minimum of tools — no fuss or complications, even with fixed piping.

### Safety

Providing safe tools and equipment is our top priority. ARO-Flo Series FRLs are designed with integrated safety features such as locking bowls and clear markings. Accessories such as lockout valves, check valves, and soft-start valves allow the air supply to be safely managed and controlled.

*Modular threaded pipe adapter: allows a unit to be quickly removed from the air line. Can be used to pipe different thread sizes in the plumbing setup.*

*Optional soft-start valve: allows system pressure to build gradually, for downstream equipment protection and safer start-up.*

*Settable gauge fan: allows the user to display the specific pressure range that is needed for the application.*

*Optional pressure switch threaded into a manifold port block: allows the sensing of high or low pressure thresholds set by the end user.*

*Oil drip rate controlled by turning the sight dome screw clockwise or counter-clockwise.*

*Auto-fill: oil can be added under pressure.*



*T-bracket wall mount: standard on all combo units.*

*Modular lockout valve: units are threaded for direct plumbing or can be installed in the modular arrangement.*

*Optional service indicator (2000 and 3000 Series). Delivered as standard on coalescing filters.*

*Panel nut: standard on all individual regulators and piggybacks.*

*Optional tamper kit installs in seconds (see ARO-Flo spare parts).*

*ARO-Flo check valve: typically installed downstream of the regulator. Used to prevent downstream pressure from moving upstream in case of upstream pressure loss.*

*The installation of a manifold port block enables design flexibility by allowing clean, regulated air to be diverted to other applications.*

# ARO-Flo Series Air Filters, Regulators & Lubricators

## Installation

For best performance the flow required for your tool or equipment shall be matched with ARO-Flo capacity. When installing FRL observe the order shown in the illustration.

Individual take-off lines to the FRL should be from the top of the compressed air supply line. Observe air flow direction marks on FRLs.

To trap and expel water and contaminants, drip leg drains should be installed at low points in air distribution system and at its far end. If a coalescing filter is required, it should be installed downstream from a standard filter.

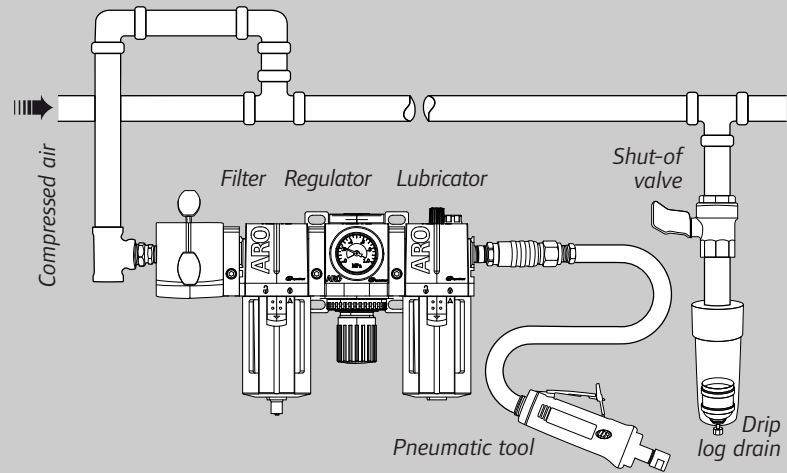

## Flow Capacities in l/min (scfm)<sup>(1)</sup>

Series	Port Size	Filter	Coalescing filter	Regulator	Lubricator	Piggyback
1000	1/8"	1070 (38)	480 (17)	1270 (45)	900 (32)	1210 (43)
	1/4"	1380 (49)	650 (23)	1670 (59)	1440 (51)	1330 (47)
1500	1/4"	2060 (73)	960 (34)	2430 (86)	1440 (51)	2040 (72)
	3/8"	3030 (107)	1410 (50)	3200 (113)	2970 (105)	2550 (90)
2000	3/8"	4420 (156)	2010 (71)	5070 (179)	2400 (85)	3740 (132)
	1/2"	5580 (197)	2600 (92)	5940 (210)	4420 (156)	4770 (172)
	3/4"	6110 (216)	2860 (101)	5940 (210)	6280 (222)	4900 (173)
3000	3/4"	8150 (288)	3740 (132)	8210 (290)	9340 (330)	6680 (236)
	1"	9990 (353)	3960 (140)	8210 (290)	9340 (330)	7080 (250)

(1) **Filter:** at 6.2 bar (90 psig) inlet, and 0.7 bar (10 psig) pressure drop.

**Lubricator:** at 6.2 bar (90 psig) inlet and 0.5 bar (7 psig) pressure drop.

**Regulator and Piggyback:** at 6.9 bar (100 psig) inlet, 6.2 bar (90 psig) set pressure and 2.3 bar (33 psig) pressure drop.

## Bowl Capacities in ml

Series	FILTERS, COALESCING FILTERS and PIGGYBACKS <sup>(2)</sup>				LUBRICATORS	
	Polycarbonate bowl <sup>(3)</sup>		Metal bowl		Polycarbonate bowl <sup>(3)</sup>	Metal bowl
	Manual drain	Auto drain	Manual drain	Auto drain		
1000	14 (9)	20 (14)	13 (9)	21 (14)	17	21
1500	36	31	37	30	56	43
2000	57	68	72	83	128	110
3000	—	—	156 (138)	174 (154)	—	110

(2) Numbers in brackets are given for coalescing filters only.

(3) Some compressor oils, chemical cleaners, solvents, paints, and their fumes can attack **polycarbonate** and cause bowl failure. See instruction manual for details.

## Temperature Range & Maximum Inlet Pressure

Series	Temperature range	Maximum pressure
Polycarbonate bowl	-5 to 52° C	10.3 bar (150 psig)
Metal bowl	-5 to 79° C	17.2 bar (250 psig)
Regulator	-5 to 60° C	17.2 bar (250 psig)



ARO-Flo Series equipment is exempt from the EU Directives 2002/95/EC (CE compliance), and 94/9/EC (ATEX 95). ARO-Flo Series is Silicon free and meets 2002/95/EC (RoHS compliance).

# ARO-Flo Series Air Filters, Regulators & Lubricators

## ARO-Flo Filters

ARO-Flo compressed air filters are designed to remove airborne solid and liquid contaminants which may plug small orifices and hinder performance, or cause excessive wear and premature equipment failure. Standard filters are supplied with 5-micron elements. 40-micron elements can be purchased and installed separately. Coalescing models are capable of removing oil aerosols and particles down to 0.3 micron. All filters have aluminium body, nitrile seals and acetal baffle. Drain: brass + nitrile (manual), acetal (automatic). Filter insert from Polyethylene (or HEPA paper + felt for coalescing).

Part no.	Series		Max. flow (l/min)	Bowl material and drain type
<b>Standard Air Filters</b>				
F351B1-400	1000	1/4" BSP	1 380	Polycarbonate / Manual
F351B1-421				Metal / Automatic
F352C1-400	1500	3/8" BSP	3 030	Polycarbonate / Manual
F352C1-411				Metal / Automatic
F353D1-400	2000	1/2" BSP	5 580	Polycarbonate / Manual
F353D1-411				Metal / Automatic
F353E1-400		3/4" BSP	6 110	Polycarbonate / Manual
F353E1-411				Metal / Automatic
F354E1-410	3000	3/4" BSP	8 150	Metal / Manual
F354F1-410		1" BSP	9 990	Metal / Manual
<b>Coalescing Air Filters with Service Indicator</b>				
F353D2-311	2000	1/2" BSP	2 600	Metal / Automatic
F354E2-311	3000	3/4" BSP	3 740	Metal / Automatic
F354F2-311		1" BSP	3 960	Metal / Automatic

## ARO-Flo Regulators

ARO-Flo regulators provide controlled, consistent air pressure as required for pneumatic equipment. Rigid aluminium body with nitrile O-rings, acetal knob, steel springs, nylon/polycarbonate gauge cover and 1/8" gauge port. Diaphragm: Nitrile + nylon (nitrile + acetal for Series 1000). Regulator valve: Nitrile + nylon (brass + nitrile for Series 1000). Panel nut included with regulator.

Alternative springs are offered to suit different pressure requirements (see page 8). Non-relieving regulators can be offered if venting of downstream overpressure is undesirable. Please use service kits listed on accessories / spare parts page to convert from relieving to non-relieving models.

Part no.	Series		Max. flow (l/min)	Pressure range
<b>Standard Air Regulators</b>				
R371B1-600	1000	1/4" BSP	1670	0 - 9.6 bar (0 - 140 psig)
R372C1-600	1500	3/8" BSP	3200	
R373D1-600	2000	1/2" BSP	5940	
R373E1-600		3/4" BSP	5940	
R374E1-600	3000	3/4" BSP	8210	17.2 bar (250 psig)
R374F1-600		1" BSP	8210	



**F 3 5 3 D 1 - 4 0 0**

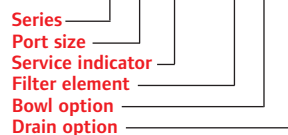

Models not listed in the table are available on special request. Not all combinations available.

- Series**  
1 = 1000 Series 2 = 1500 Series  
3 = 2000 Series 4 = 3000 Series
- Port size**  
1 = 1/8" NPT A = 1/8" BSP  
2 = 1/4" NPT B = 1/4" BSP  
3 = 3/8" NPT C = 3/8" BSP  
4 = 1/2" NPT D = 1/2" BSP  
5 = 3/4" NPT E = 3/4" BSP  
6 = 1" NPT F = 1" BSP
- Service indicator**  
1 = None  
2 = Mechanical (for coalescing) for 2000 & 3000 Series only

- Filter element**  
3 = 0.3 micron coalescing  
4 = 5 micron
- Bowl option**  
0 = Polycarbonate with guard (without guard on 1000 Series)  
1 = Metal with sight glass (not available on 1000 Series)  
2 = Metal without sight glass
- Drain option**  
0 = Manual  
1 = Automatic



**R 3 7 3 D 1 - 6 0 0**

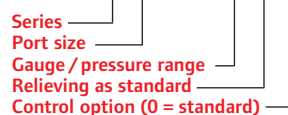

Models not listed in the table are available on special request. Not all combinations available.

- Series**  
1 = 1000 Series 2 = 1500 Series  
3 = 2000 Series 4 = 3000 Series
- Port size**  
1 = 1/8" NPT A = 1/8" BSP  
2 = 1/4" NPT B = 1/4" BSP  
3 = 3/8" NPT C = 3/8" BSP  
4 = 1/2" NPT D = 1/2" BSP  
5 = 3/4" NPT E = 3/4" BSP  
6 = 1" NPT F = 1" BSP

- Gauge / pressure range**  
1 = 0 - 9.6 bar (0 - 140 psig) no gauge.  
2 = 0 - 4 bar (0 - 60 psig) no gauge.  
3 = 0.7 - 14 bar (10 - 200 psig) no gauge, on 2000 & 3000 Series only.  
4 = 0 - 2 bar (0 - 30 psig) no gauge.  
6 = 0 - 9.6 bar (0 - 140 psig) with flush mount gauge = standard.

# ARO-Flo Series Air Filters, Regulators & Lubricators

## ARO-Flo Lubricators

ARO-Flo mist-type lubricators are designed to provide the correct amount of oil required for most general applications in a pneumatic system, delivering a constant ratio of oil to air flow. Precise oil feed adjustment sets the proper oil drip rate.

Lubricators should be installed close to the downstream application to ensure effective distribution of oil. All lubricators are with aluminium body, nitrile seals, nylon sight dome and urethane inlet tube.

Oil refill can be done under pressure.



Part no.	Series		Max. flow (l/min)	Bowl material
<b>Standard Air Lubricators</b>				
L361B1-100	1000	1/4" BSP	1440	Polycarbonate
L361B1-120				Metal
L362C1-100	1500	3/8" BSP	2970	Polycarbonate
L362C1-110				Metal
L363D1-100	2000	1/2" BSP	4420	Polycarbonate
L363D1-110				Metal
L363E1-100		3/4" BSP	6280	Polycarbonate
L363E1-110				Metal
L364F1-110	3000	1" BSP	9340	Metal

**L 3 6 3 D 1 - 1 0 0**

Series  
Port size  
Adjustment option (1= std.)  
Bowl option  
Fill option (0 = std.)

Models not listed in the table are available on special request. Not all combinations available.

**Series**  
1 = 1000 Series    2 = 1500 Series  
3 = 2000 Series    4 = 3000 Series

**Port size**  
1 = 1/8" NPT    A = 1/8" BSP  
2 = 1/4" NPT    B = 1/4" BSP  
3 = 3/8" NPT    C = 3/8" BSP  
4 = 1/2" NPT    D = 1/2" BSP  
5 = 3/4" NPT    E = 3/4" BSP  
6 = 1" NPT      F = 1" BSP

**Bowl option**  
0 = Polycarbonate with guard (without guard on 1000 Series)  
1 = Metal with sight glass (not available on 1000 Series)  
2 = Metal without sight glass

## ARO-Flo Piggybacks

"Piggybacks" combine the functions of both a filter and regulator. Piggybacks are compact and most effective when space is a constraint.

They can be ordered with different filter elements and can be modified with different springs, depending on the filtration and air regulating requirements (see accessories page 8).

Delivered as standard with panel nut.



Part no.	Series		Max. flow (l/min)	Bowl material and drain type
<b>Standard Piggybacks</b>				
P391B4-600	1000	1/4" BSP	1330	Polycarbonate / Manual
P391B4-624				Metal / Automatic
P392C4-600	1500	3/8" BSP	2550	Polycarbonate / Manual
P392C4-614				Metal / Automatic
P393D4-600	2000	1/2" BSP	4770	Polycarbonate / Manual
P393D4-614				Metal / Automatic
P393E4-600		3/4" BSP	4900	Polycarbonate / Manual
P393E4-614				Metal / Automatic
P394F4-610	3000	1" BSP	7080	Metal / Manual

**P 3 9 3 D 4 - 6 0 0**

Series  
Port size  
Filter element (4 = std. 5µ)  
Gauge (6 = std.)  
Bowl option  
Drain option

Models not listed in the table are available on special request. Not all combinations available.

**Series**  
1 = 1000 Series    2 = 1500 Series  
3 = 2000 Series    4 = 3000 Series

**Port size**  
1 = 1/8" NPT    A = 1/8" BSP  
2 = 1/4" NPT    B = 1/4" BSP  
3 = 3/8" NPT    C = 3/8" BSP  
4 = 1/2" NPT    D = 1/2" BSP  
5 = 3/4" NPT    E = 3/4" BSP  
6 = 1" NPT      F = 1" BSP

**Bowl option**  
0 = Polycarbonate with guard (without guard on 1000 Series)  
1 = Metal with sight glass (not available on 1000 Series)  
2 = Metal without sight glass

**Drain option**  
0 = Manual  
4 = Automatic

# ARO-Flo Series Air Filters, Regulators & Lubricators

## ARO-Flo 2 and 3 Piece Combination Units

Filters, regulators, lubricators and piggybacks can be combined together. They are typically strung together in the F+R+L arrangement (three-piece combo) and F/R+L (two-piece combo) arrangement, although other configurations are also used depending on application needs.

All ARO-Flo Combinations have a 5 micron filter element and a relieving regulator 0-9.7 bar (0-140 psig) with flush mount gauge. They are supplied assembled with modular T-shape wall mount bracket kits. The panel nuts are not included with units. They must be ordered separately if needed.

- Standard 2-pieces combo includes polycarbonate bowls with sight glass (except 3000 Series with metal bowls / sight glass) and manual drain.
- Standard 3-pieces combo includes metal bowls with sight glass (except 1000 Series, no sight glass) and automatic drain.



Part no.	Series		Max. flow (l/min)	Bowl material and drain type
<b>2-piece Combined Units (F/R + L)</b>				
C381B1-600	1000	1/4" BSP	1240	Polycarbonate / Manual
C382C1-600	1500	3/8" BSP	2010	Polycarbonate / Manual
C383D1-600	2000	1/2" BSP	3400	Polycarbonate / Manual
C383E1-600		3/4" BSP	4020	Polycarbonate / Manual
C384F1-610	3000	1" BSP	5890	Metal / Manual
<b>3-piece Combined Units (F + R + L)</b>				
C381B1-821	1000	1/4" BSP	1300	Metal / Automatic
C382C1-811	1500	3/8" BSP	2400	Metal / Automatic
C383D1-811	2000	1/2" BSP	4250	Metal / Automatic
C383E1-811		3/4" BSP	4840	Metal / Automatic
C384F1-811	3000	1" BSP	6090	Metal / Automatic

### C 3 8 3 D 1 - 6 0 0

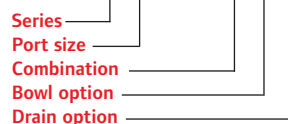

Models not listed in the table are available on special request. Not all combinations available.

- Series**  
 1 = 1000 Series    2 = 1500 Series  
 3 = 2000 Series    4 = 3000 Series
- Port size**  
 1 = 1/8" NPT    A = 1/8" BSP  
 2 = 1/4" NPT    B = 1/4" BSP  
 3 = 3/8" NPT    C = 3/8" BSP  
 4 = 1/2" NPT    D = 1/2" BSP  
 5 = 3/4" NPT    E = 3/4" BSP  
 6 = 1" NPT    F = 1" BSP
- Combination**  
 6 = Filter/Regulator + Lubricator  
 8 = Filter+ Regulator + Lubricator

- Bowl option**  
 0 = Polycarbonate with guard (without guard on 1000 Series)  
 1 = Metal with sight glass (not available on 1000 Series)  
 2 = Metal without sight glass
- Drain option**  
 0 = Manual  
 1 = Automatic

# ARO-Flo Series Air Filters, Regulators & Lubricators

## ARO-Flo Series Accessories

Description	1000 Series	1500 Series	2000 Series	3000 Series
Lock-out valve (BSP)	104390-B (1/4")	104391-C (3/8")	104392-D (1/2")	104393-F (1")
2 threaded pipe adapters (BSP)	104474-B (1/4")	104475-C (3/8")	104398-D (1/2")	104476-F (1")
Check valve (NPT)	104477-2 (1/4")	104478-2 (1/4")	104479-3 (3/8")	—
Threaded manifold block (NPT)	104411-1-1 (1/4" x 1/8")	104412-3-1 (3/8" x 3/8")	104413-4-2 (1/2" x 1/4")	—
	104411-2-2 (1/4" x 1/4")	104412-3-2 (3/8" x 1/4")	104413-4-3 (1/2" x 3/8")	—
Modular clamp spacer kit	104394	104395	104396	104397
T-bracket / spacer	104399	104400	104401	104402
L-bracket (for piggyback)	104403	104404	104405	104406
Panel nut (for L-bracket)	104416	104417	104418	104419
Pressure sensor (connects to 1/8" port)	104415	104415	104415	—
Gauge port block	104467	104467	104469	104469
24VDC soft start valve, 1/2" BSP	—	—	SSVD3-024-D	—
240V AC soft start valve, 1/2" BSP	—	—	SSVD3-240-A	—

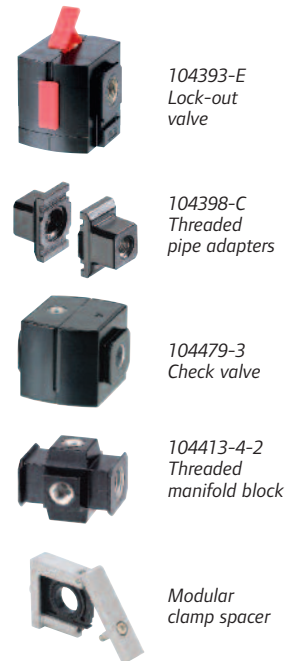

## ARO-Flo Series Spare Parts

Description	1000 Series	1500 Series	2000 Series	3000 Series
<b>Filter</b>				
Automatic drain	104293	104315	104315	104315
Manual drain kit (contains bowl O-ring)	104468	104429	104326	104452
5 micron element	104295	104422	104317	104445
40 micron element	104296	104423	104318	104446
0.3 micron element for standard bowl	—	104424	104319	—
Polycarbonate bowl with manual drain	104298	104425	104320	—
Polycarbonate bowl with auto drain	104299	104426	104321	—
Metal bowl with sight glass & manual drain	104300	104481	104325	104450
Metal bowl with sight glass & auto drain	104301 (1)	104482	104324	104451
Coalescing filter bowl with manual drain	104459 (1)	—	—	104461
Coalescing filter bowl with auto drain	104460	—	—	104462
0.3 micron element for coalescing bowl	104297	—	—	104447
<b>Regulator</b>				
Regulator service kit (relieving)	104302	104430	104327	104453
Regulator service kit (non-relieving)	104303	104431	104328	104454
Anti-tamper kit	104304	104432	104329	104455
Spring 0 - 2 bar (0 - 30 psig)	104305	104433	—	—
Spring 0 - 4.1 bar (0 - 60 psig)	104306	104434	104330	104456
Spring 0 - 9.6 bar (0 - 140 psig)	104307	104435	104331	104457
Gauge 0 - 9.6 bar (0 - 140 psig), flush-mount	104310	104310	104334	104334
Spring 0.7 - 13.8 bar (10-200 psig)	—	—	104332	104458
<b>Lubricator</b>				
Lubricator polycarbonate bowl with guard	104311	104439	104336	—
Lubricator metal bowl with sight glass	104312 (1)	104440	104338	104338
Lubricator service kit	104313	104441	104339	104465
Sight dome repair kit (incl. inner dome)	104314	104442	104470	104466

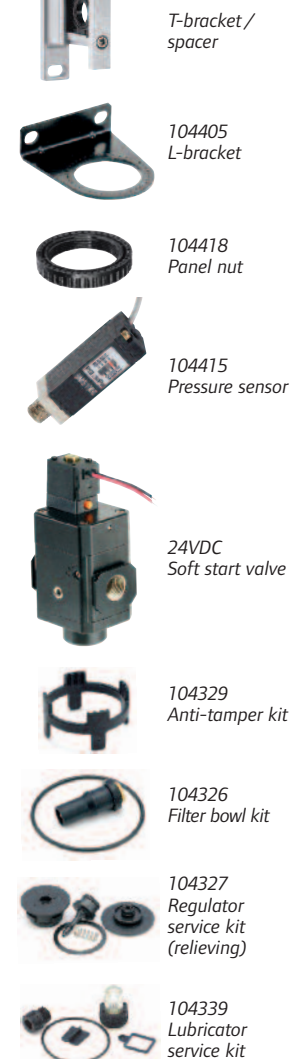

(1) Sight glass is not supplied with the 1000 Series.



# ARO-Flo Series Air Filters, Regulators & Lubricators

## ARO-Flo Series Dimensions

Product	Part no.	Series	Dimensions (mm)				
			A	B	C	D	E
FILTERS	F351B1-400	1000	110	40	46	20	90
	F351B1-421		127	40	46	20	107
	F352C1-400	1500	157	56	57	25	132
	F352C1-411		179	56	57	25	154
	F353D1-400	2000	179	70	73	28	151
	F353D1-411		201	70	73	28	173
	F353E1-400		179	76	73	28	151
	F353E1-411	3000	201	76	73	28	173
	F354E1-410		252	90	98	38	214
	F354F1-410		252	90	98	38	214
COALESCING FILTER	F353D2-311	2000	218	70	73	45	173
	F354E2-311	3000	292	90	98	55	237
	F354F2-311		292	90	98	55	237
REGULATOR	R371B1-600	1000	91	40	74	24	67
	R372C1-600	1500	121	56	79	32	89
	R373D1-600	2000	140	70	80	37	103
	R373E1-600		140	70	80	37	103
	R374E1-600	3000	184	90	104	51	133
	R374F1-600		184	90	104	51	133
LUBRICATOR	L361B1-100	1000	128	40	46	42	86
	L361B1-120		128	40	46	42	86
	L362C1-100	1500	152	56	57	45	107
	L362C1-110		152	56	57	45	107
	L363D1-100	2000	180	70	73	43	137
	L363D1-110		182	70	73	43	139
	L363E1-100		180	70	73	43	137
	L363E1-110	3000	182	70	73	43	139
L364F1-110	257		90	98	55	202	
PIGGYBACK	P391B4-600	1000	157	40	74	67	90
	P391B4-624		175	40	74	67	108
	P392C4-600	1500	207	56	79	86	121
	P392C4-614		229	56	79	86	143
	P393D4-600	2000	253	70	80	100	153
	P393D4-614		276	70	80	100	176
	P393E4-600		253	70	80	100	153
	P393E4-614	3000	276	70	80	100	176
P394F4-610	347		90	104	133	214	
2-PIECE COMBINED UNIT	C381B1-600	1000	157	80	80	67	90
	C382C1-600	1500	209	112	84	86	123
	C383D1-600	2000	252	145	90	100	152
	C383E1-600		252	145	90	100	152
	C384F1-610	3000	351	186	109	133	218
3-PIECE COMBINED UNIT	C381B1-821	1000	149	120	80	42	107
	C382C1-811	1500	199	168	84	45	154
	C383D1-811	2000	216	221	90	43	173
	C383E1-811		216	221	90	43	173
	C384F1-811	3000	292	282	109	55	237

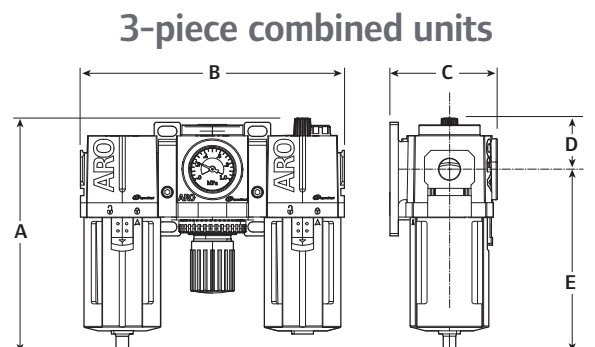
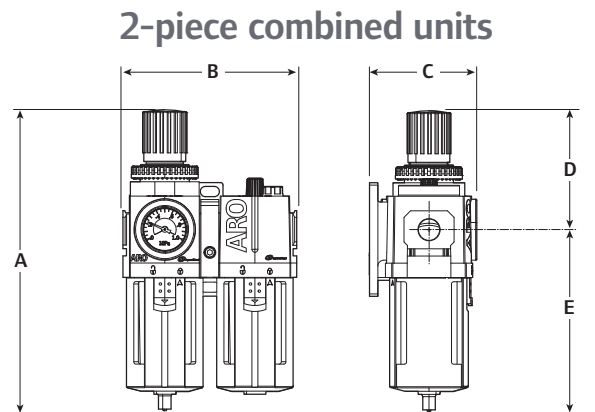
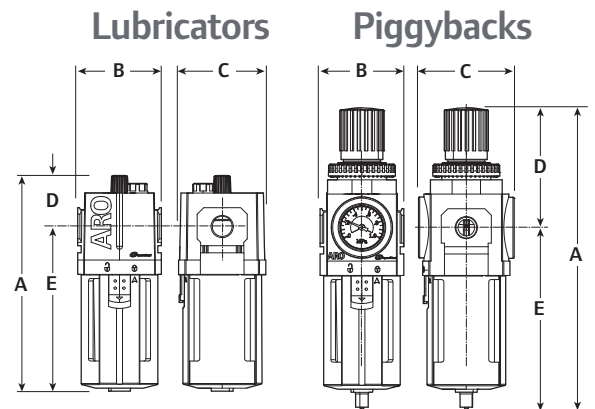
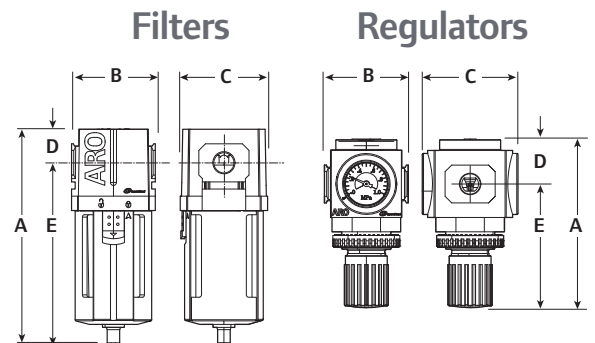

Air Treatment

# ARO-Flo Series Air Filters, Regulators & Lubricators

## ARO-Flo Series Flow Charts

### 1000 Series

**Filter 1/4" pressure drop test**

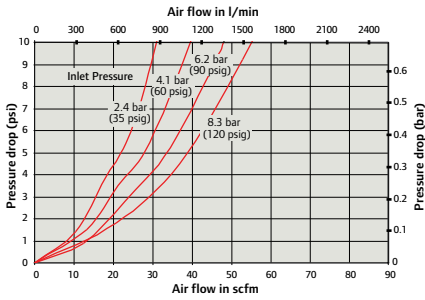

**Regulator 1/4" pressure drop test**

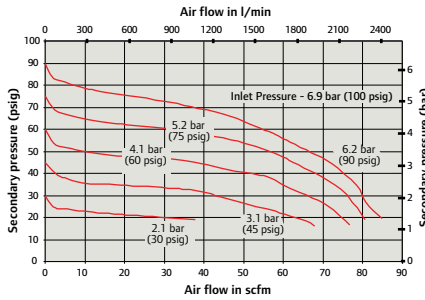

**Lubricator 1/4" pressure drop test**

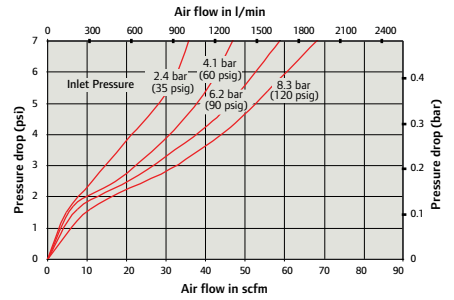

### 1500 Series

**Filter 3/8" pressure drop test**

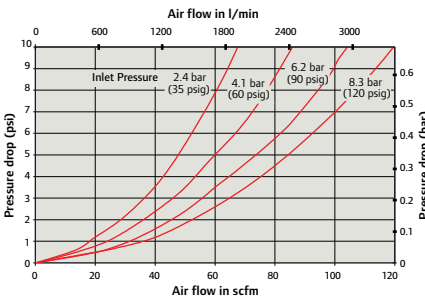

**Regulator 3/8" pressure drop test**

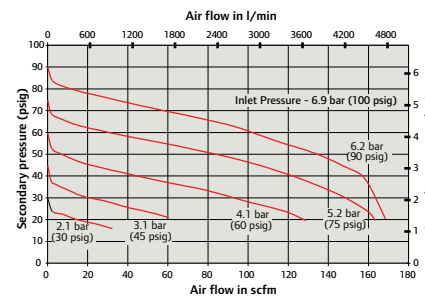

**Lubricator 3/8" pressure drop test**

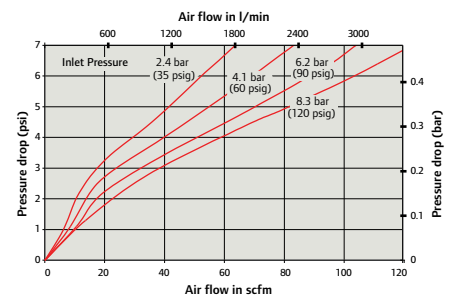

### 2000 Series

**Filter 1/2" & 3/4" pressure drop test**

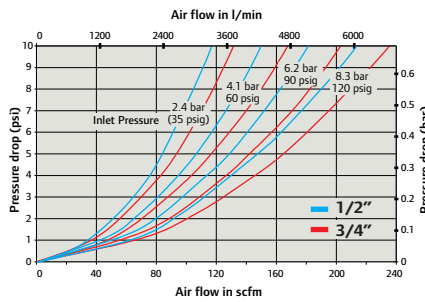

**Regulator 1/2" & 3/4" pressure drop test**

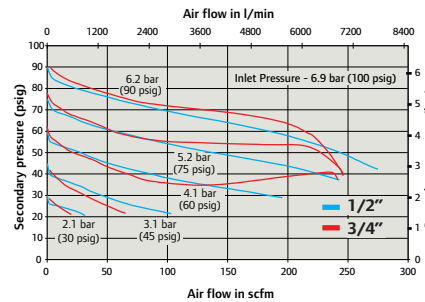

**Lubricator 1/2" & 3/4" pressure drop test**

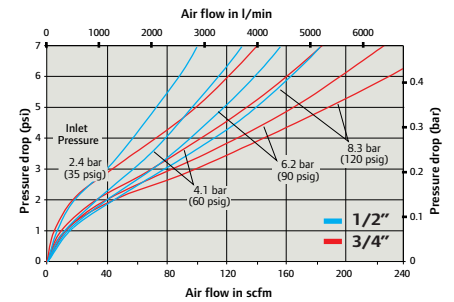

### 3000 Series

**Filter 3/4" & 1" pressure drop test**

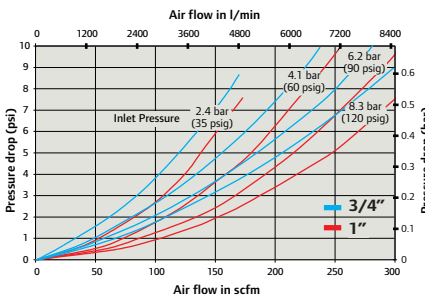

**Regulator 3/4" & 1" pressure drop test**

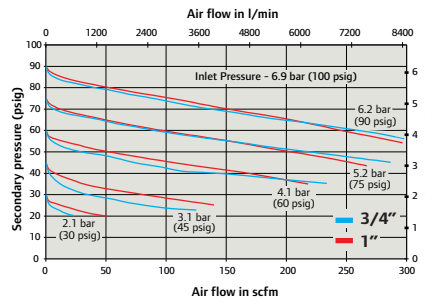

**Lubricator 1" pressure drop test**

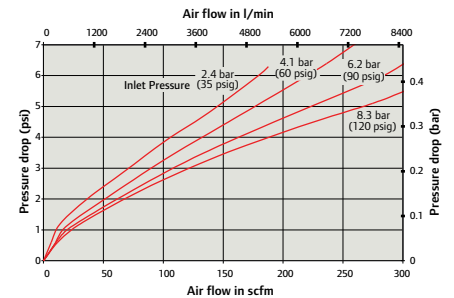

# ARO-Flo Series Air Filters, Regulators & Lubricators

## ARO-Flo Series Flow Charts

### 1000 Series

**Piggyback 1/4" pressure drop test**

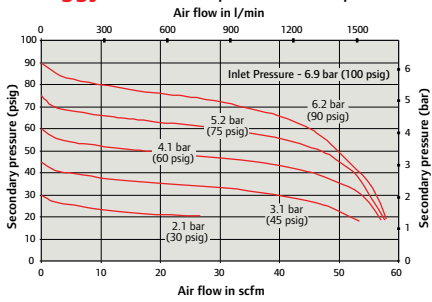

**F/R+L 1/4" pressure drop test**

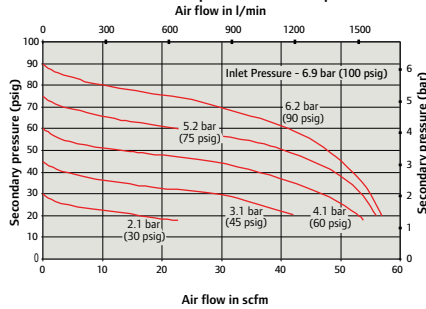

**F+R+L 1/4" pressure drop test**

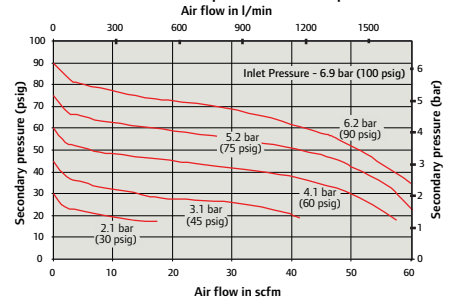

### 1500 Series

**Piggyback 3/8" pressure drop test**

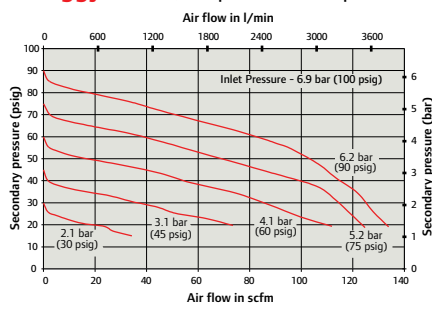

**F/R+L 3/8" pressure drop test**

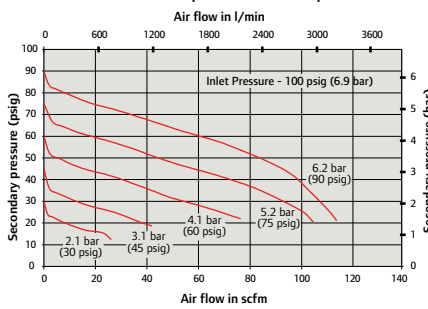

**F+R+L 3/8" pressure drop test**

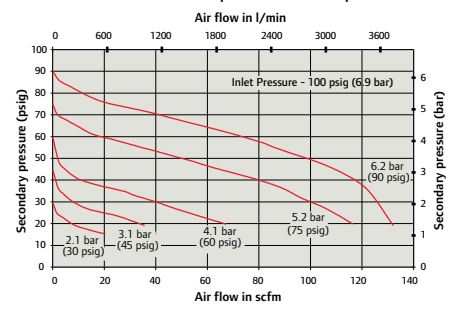

### 2000 Series

**Piggyback 1/2" & 3/4" pres. drop test**

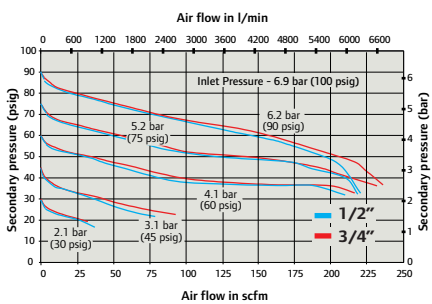

**F/R+L 1/2" & 3/4" pressure drop test**

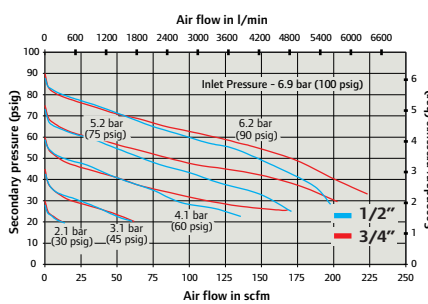

**F+R+L 1/2" & 3/4" pressure drop test**

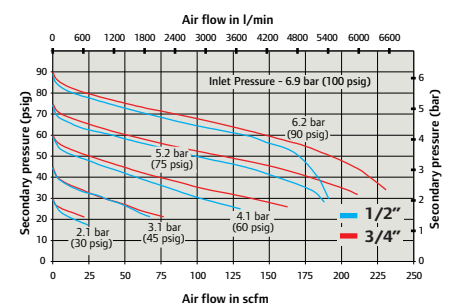

### 3000 Series

**Piggyback 1" pressure drop test**

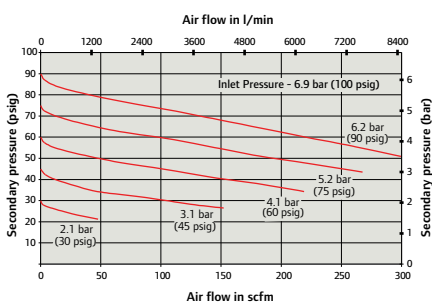

**F/R+L 1" pressure drop test**

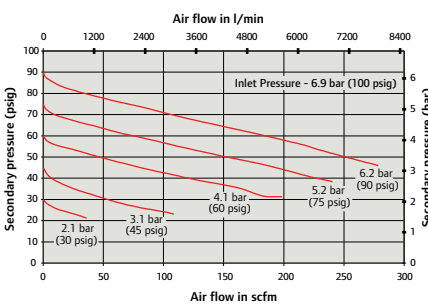

**F+R+L 1" pressure drop test**

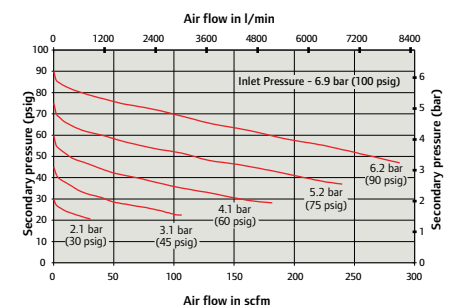

# Super Duty Series Air Filters, Regulators & Lubricators

## Super Duty Filters

- High-flow filter element with 5-micron filtration.
- Differential pressure indicator to eliminate the guesswork of element replacement.
- Robust cast aluminium housings to withstand operating pressures up to 20.7 bar (300 psig). Maximum supply pressure limited to 10.3 bar (150 psig) with pressure indicator.
- All filters have plated steel internal components and fluorocarbon seals. Filter insert from polyethylene/polypropylene.
- Accessory: part no. **104512**, all sizes wall mount pipe clamp.



F355H1-411

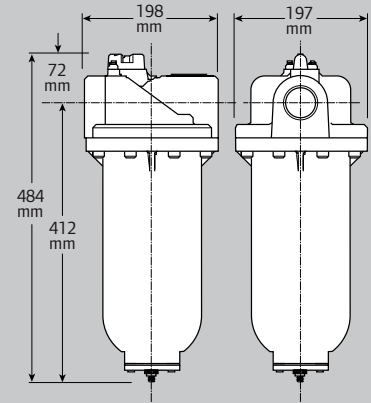

Part no.		Max. flow (m <sup>3</sup> /min)	Bowl capacity (litre)	Bowl material and drain type
<b>Standard Air Filters</b>				
F355G1-411	1 1/4" BSP	27.5 <sup>(1)</sup>	0.37	Aluminium / Automatic
F355H1-411	1 1/2" BSP	36.2 <sup>(1)</sup>	0.37	Aluminium / Automatic
F355J1-411	2" BSP	39.6 <sup>(1)</sup>	0.37	Aluminium / Automatic

(1) At 10.3 bar (150 psig) inlet pressure. Pressure drop of 0.3 bar (5 psig).  
Operating temperature: 0 - 65°C.

## Super Duty Regulators

- High-flow capacity.
- Balanced valve design for excellent regulation characteristics.
- Maximum inlet pressure 20.7 bar (300 psig).
- Two 1/4" NPT gauge ports as standard for manometer and/or additional outlet port. Gauge to be ordered separately.
- Regulator body, piston and bonnet from zinc. Valve assembly from brass, nitrile and acetal. Nitrile seals.
- Accessories:
  - Part no. **104502**, 1/4" port gauge – 0 to 11 bar (0-160 psig),
  - Part no. **104512**, all sizes wall mount pipe clamp.



R375H1-100

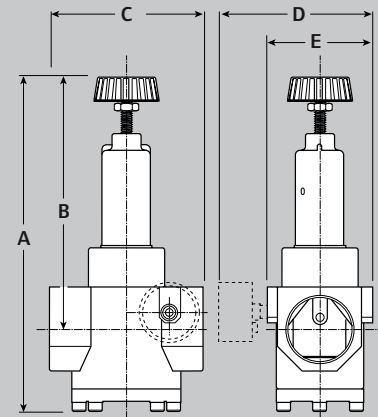

Dimensions in mm

Part no.		Max. flow (m <sup>3</sup> /min)	Adjusting pressure range
<b>Standard Air Regulators</b>			
R375G1-100	1 1/4" BSP	22.6 <sup>(2)</sup>	0 - 8.5 bar (0 - 125 psig)
R375H1-100	1 1/2" BSP	34.0 <sup>(3)</sup>	
R375J1-100	2" BSP	34.0 <sup>(3)</sup>	

Part no.	A	B	C	D	E
R375G1-100	262	219	109	109	67
R375H1-100	302	231	135	135	91
R375J1-100	302	231	135	135	91

(2) At 6.9 bar (100 psig) inlet pressure, secondary pressure of 5.5 bar (80 psig).  
(3) At 6.9 bar (100 psig) inlet pressure, secondary pressure of 5.9 bar (85 psig).  
Operating temperature: 0 - 65°C.



104502 optional gauge

# Super duty Series Air Filters, Regulators & Lubricators

## Super Duty Lubricators

- Full view sight dome.
- Siphon tube filter provides clean lubricant downstream.
- Adjustable oil feed.
- Standard transparent bowl with metal bowl guard.
- Can be filled while under pressure – Max 13.8 bar at inlet.
- Lubricator body in zinc. Fluorocarbon seals. Sight dome in nylon.
- Accessory: part no. **104512**, all sizes wall mount pipe clamp.

L365H1-110

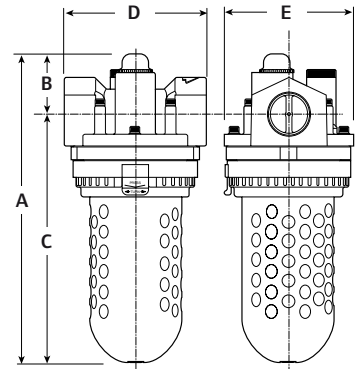

Air Treatment

Part no.		Max. flow (m <sup>3</sup> /min)	Bowl capacity (litre)	Bowl material
<b>Standard Air Lubricators</b>				
L365G1-110	1 1/4" BSP	26.2 <sup>(4)</sup>	0.77	Metal / Transparent
L365H1-110	1 1/2" BSP	26.2 <sup>(4)</sup>	0.77	Metal / Transparent
L365J1-110	2" BSP	33.6 <sup>(4)</sup>	0.77	Metal / Transparent

Dimensions in mm

Part no.	A	B	C	D	E
L365G1-110	295	58	237	140	127
L365H1-110	295	58	237	140	127
L365J1-110	311	66	245	140	127

(4) At 8 bar (120 psig) inlet pressure. Pressure drop of 0.3 bar (5 psig).

Operating temperature: 0 - 65°C.

## Super Duty Series Flow Charts

### 1 1/4" Series

#### Filter 1 1/4" pressure drop test

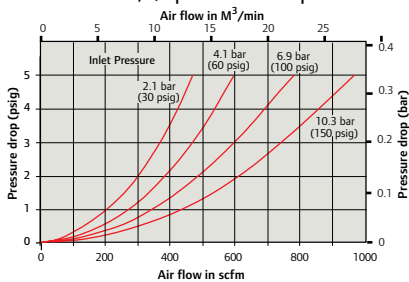

#### Regulator 1 1/4" pressure drop test

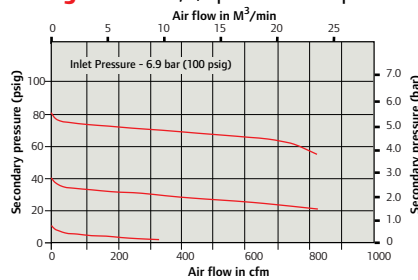

#### Lubricator 1 1/4" pressure drop test

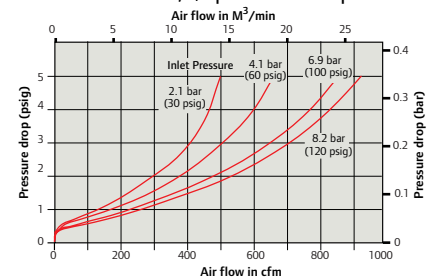

### 1 1/2" Series

#### Filter 1 1/2" pressure drop test

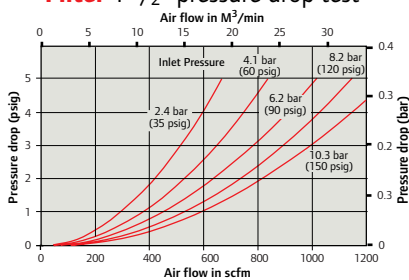

#### Regulator 1 1/2" pressure drop test

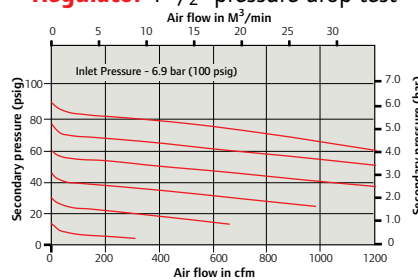

#### Lubricator 1 1/2" pressure drop test

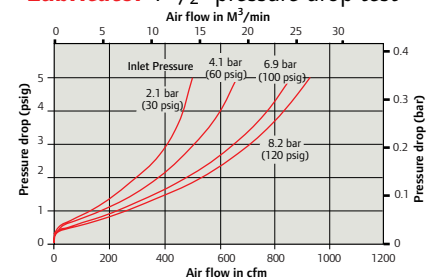

### 2" Series

#### Filter 2" pressure drop test

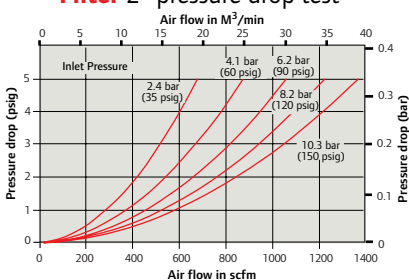

#### Regulator 2" pressure drop test

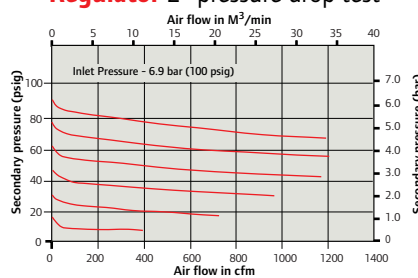

#### Lubricator 2" pressure drop test

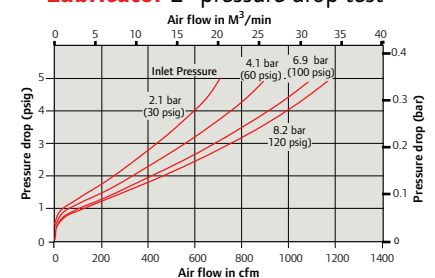

# Special Airline Products

## Dial-Air™ Regulators

These regulators feature a transparent pressure-calibrated, nonrising adjustment dial which allows one to dial any secondary pressure. If a gauge is required for monitoring reasons, two 1/4" gauge ports are provided: however, these are usually used for additional outlet port. In less than 270° turn, the full secondary pressure range can be dialed. This feature is particularly advantageous if secondary pressure must be changed frequently.

- Regulator body and bonnet from zinc. Piston from acetal (R21) or zinc (R31 and 41). Valve assembly from brass, nitrile and acetal. Nitrile seals.
- Maximum inlet pressure 20.7 bar (300 psig) – adjusting pressure range 0 to 11 bar (0-160psi).



Part no.		Max. flow (l/min)	Dimensions (mm)	
			A	B
R21-C2-000-29	1/4" BSP	3 300 <sup>(1)</sup>	104	81
R21-C4-000-29	1/2" BSP	5 520 <sup>(1)</sup>	104	81
R21-C6-000-29	3/4" BSP	6 240 <sup>(1)</sup>	104	81
R31-C8-000-29	1" BSP	18 300 <sup>(2)</sup>	132	109
R31-CA-000-29	1 1/4" BSP	19 800 <sup>(2)</sup>	132	109
R41-CC-000-29	2" BSP	45 300 <sup>(2)</sup>	173	135

(1) At 6.9 bar (100 psig) inlet pressure. Secondary pressure of 6.0 bar (90 psig).  
 (2) At 6.9 bar (100 psig) inlet pressure. Secondary pressure of 5.5 bar (80 psig).  
 Operating temperature: 0 - 65°C.

## Chemical Dryer

- Polycarbonate bowl with metal guard.
- Dew point -43°.
- Desiccant regeneration +117°C.
- Desiccant replacement: **DRP-85-059** (pack of 8).

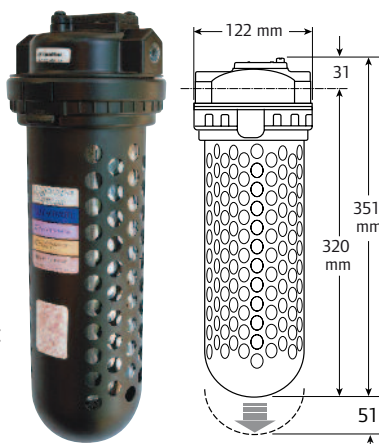

Part no.		Flow at 7 bar (l/s)	Max. pressure (bar)	Weight (kg) *
X03-C2-A29	1/4" BSP	4.7	10.3	3.4

\* With desiccant.

## Inline Lubricators

- Lubricator body from aluminium. Nitrile seals.
- Maximum inlet pressure 13.8 bar (200 psig).

**Intermittent lubricators:** oil is fed each time the air is turned on. They require cyclical or intermittent air flow for proper operation and work optimally when installed near the tool.

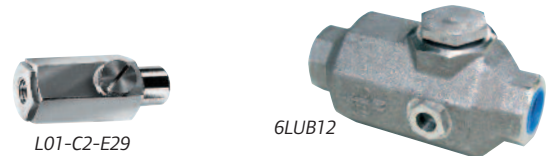

Part no.		Max. flow (l/min)	Bowl capacity (litre)	Weight (kg)
<b>Inline Lubricators / Constant Feed</b>				
L01-C2-A29	1/4"Fx1/4" F BSP	1000	0.007	0.10
L01-C2-E29	1/4"Fx1/4" M BSP	1000	0.007	0.10
L01-C3-A29	3/8"Fx3/8" M BSP	1000	0.007	0.10
8LUB16C-A3	1" F x 1" F BSP	9900	0.30	0.95
16LUB16C-A3	1" F x 1" F BSP	9900	0.56	2.00
<b>Inline Lubricators / Intermittent Feed</b>				
3LUB8	1/2"Fx1/2" F BSP	2820	0.11	0.45
6LUB12	3/4"Fx3/4" F BSP	2820	0.20	0.70
8LUB12-A3	3/4"Fx3/4" F BSP	4920	0.30	0.95
16LUB16-A3	1" F x 1" F BSP	9900	0.56	2.00

\* Max. operating temperature: 175° C

## Automatic Drains

- No electrical connection - easy to install.
- Quick disconnected clamp ring for easy bowl removal when servicing.
- Transparent bowl with metal guard as standard.

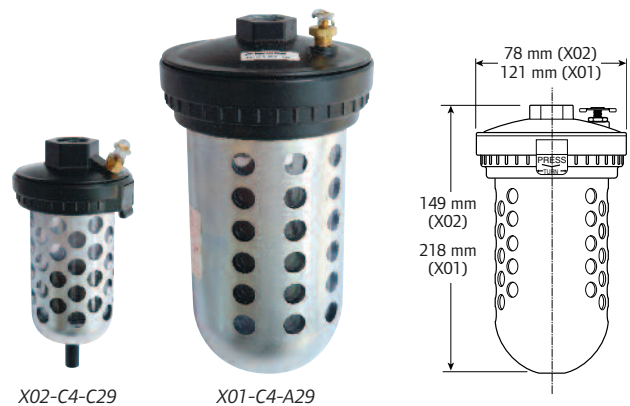

Part no.		Capacity at 6.9 bar (l/hr)	Max. pressure (bar)	Weight (kg)
X02-C4-C29	1/2" BSP	300	10.3	0.6
X01-C4-A29	1/2" BSP	570	10.3	2.1

## Reducing Nipples

Male-male reducing nipple – steel



Part no.	Ø M1	Ø M2	Quantity
36020	1/4"	1/8"	5
36011	1/4"	1/4"	5
36021	3/8"	1/4"	5
36012	3/8"	3/8"	5
36031	1/2"	1/4"	5
36022	1/2"	3/8"	5
36013	1/2"	1/2"	5
36023	3/4"	1/2"	5
36014	3/4"	3/4"	5
36024	1"	3/4"	5
36015	1"	1"	5

Male-female reducing nipple – steel

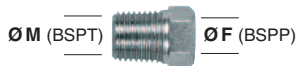

Part no.	Ø M	Ø F	Quantity
36040	1/4"	1/8"	5
36050	3/8"	1/8"	5
36041	3/8"	1/4"	5
36051	1/2"	1/4"	5
36042	1/2"	3/8"	5
36052	3/4"	3/8"	5
36043	3/4"	1/2"	5

Female-male reducing nipple – steel

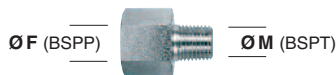

Part no.	Ø F	Ø M	Quantity
36060	1/4"	1/8"	5
36061	3/8"	1/4"	5
36062	1/2"	3/8"	5
36063	3/4"	1/2"	5

Female-female reducing nipple – steel



Part no.	Ø F1	Ø F2	Quantity
36080	1/4"	1/8"	5
36231	1/4"	1/4"	5
36081	3/8"	1/4"	5
36232	3/8"	3/8"	5
36082	1/2"	3/8"	5
36233	1/2"	1/2"	5
36083	3/4"	1/2"	5

BSPP = BSP parallel female thread.  
BSPT = BSP taper male thread.

## Male Ends

Steel



Part no.	Ø M	Ø H	Quantity
35006	1/4"	6	1
35007	1/4"	7	5
35008	1/4"	8	1
35010	1/4"	10	5
35012	1/4"	12	5
35013	1/4"	13	1
35107	3/8"	7	5
35108	3/8"	8	5
35110F	3/8"	10	5
36212	3/8"	12	5
35113	3/8"	13	1
36208	1/2"	8	1
36211	1/2"	11	1
36213	1/2"	13	1
36221	1/2"	16	5
36222	1/2"	19	5

Parkerised steel



Part no.	Ø M	Ø H	Quantity
<b>BSPT Thread</b>			
R-78	1/4"	7	5
R-108	1/4"	10	5
R-138	1/4"	13	5
R-1012	3/8"	10	5
R-1312	3/8"	13	5
R-1615	1/2"	16	5
R-1920	3/4"	19	5
R-2526	1"	25	5
<b>NPT Thread</b>			
RB-108	1/4"	10	5
RB-1312	3/8"	13	5
RB-1615	1/2"	16	5
RB-1920	3/4"	19	5

## Tool Regulator

Steel



Part no.	Dimensions
326-250	1/4" NPTF x 1/4" NPTM

## Swivel-It™ Universal Joints

Bi-directional 360° rotation, increases operator comfort and productivity.



Part no.	Dimensions	Maximum flow (l/s)
<b>Aluminium and Steel / Adjustable Flow</b>		
ASA-1/4	1/4" NPT	11.8
<b>Composite Material and Steel</b>		
ASC-1/4	1/4" NPT	15.5
<b>Aluminium and Steel</b>		
AS-3/8	3/8" NPT	21.2
AS-1/2	1/2" NPT	28.3

## Air Control Needle Valves

Composite material.  
Female threads.  
Maximum operating pressure: 13.8 bar.  
Operating temperature 0-90°C.





Part no.	Dimensions
104104-N02	1/4" NPT(F)
104104-N03	3/8" NPT(F)
104104-N04	1/2" NPT(F)
104104-N06	3/4" NPT(F)



# Quick Release Couplings & Nipples







## Standard & Safety Series

High performance couplings with slim profiles and lightweight design. High reliability against snagging and accidental disconnection. Unmatched durability and corrosion resistance.

### ISO 6150B – MIL-C4109 Profile

Bore Ø 6 mm (1/4")		Nipple (BSP)	Push-pull safety coupling Black body	Button / regular coupling Blue body/silver button	Button / safety coupling Black body/blue button
			<b>16 bar max. – Flow 15 l/s<sup>(1)</sup></b>	<b>12 bar max. – Flow 13 l/s<sup>(1)</sup></b>	
 <b>Male thread</b>	1/4" BSP 3/8" BSP 1/2" BSP	IB6NMC2 IB6NMC3 —	IBS6CCMC2 IBS6CCMC3 IBS6CCMC4	IBN6CMC2 IBN6CMC3 IBN6CMC4	IBS6CMC2 IBS6CMC3 IBS6CMC4
 <b>Female thread</b>	1/4" BSP 3/8" BSP 1/2" BSP	IB6NFC2 IB6NFC3 —	IBS6CCFC2 IBS6CCFC3 IBS6CCFC4	IBN6CFC2 IBN6CFC3 IBN6CFC4	IBS6CFC2 IBS6CFC3 IBS6CFC4
 <b>For hose</b>	Ø 6 mm Ø 8 mm Ø 10 mm	IB6NH06 IB6NH08 IB6NH10	— IBS6CCH08 IBS6CCH10	IBN6CH06 IBN6CH08 IBN6CH10	IBS6CH06 IBS6CH08 IBS6CH10

Bore Ø 8 mm (3/8")		Nipple (BSP)	Push-pull safety coupling Black body	Button / regular coupling Blue body/silver button	Button / safety coupling Black body/blue button
			<b>16 bar max. – Flow 30 l/s<sup>(1)</sup></b>	<b>12 bar max. – Flow 33 l/s<sup>(1)</sup></b>	
 <b>Male thread</b>	1/4" BSP 3/8" BSP 1/2" BSP	IB8NMC2 IB8NMC3 IB8NMC4	— IBS8CCMC3 IBS8CCMC4	— IBN8CMC3 IBN8CMC4	IBS8CMC2 IBS8CMC3 IBS8CMC4
 <b>Female thread</b>	1/4" BSP 3/8" BSP 1/2" BSP	IB8NFC2 IB8NFC3 IB8NFC4	— IBS8CCFC3 IBS8CCFC4	— IBN8CFC3 IBN8CFC4	IBS8CFC2 IBS8CFC3 IBS8CFC4
 <b>For hose</b>	Ø 8 mm Ø 10 mm Ø 13 mm	IB8NH08 IB8NH10 IB8NH13	IBS8CCH08 IBS8CCH10 IBS8CCH13	— IBN8CH10 IBN8CH13	IBS8CH08 IBS8CH10 IBS8CH13









Bore Ø 11 mm (1/2")		Nipple (BSP)	Push-pull safety coupling Black body	Bore Ø 11 mm (1/2")	Nipple (NPT)	Safety coupling Full Bore Steel
			<b>16 bar max. – Rated flow 70 l/s<sup>(1)</sup></b>	<b>20 bar max. – Rated flow 71 l/s<sup>(1)</sup></b>		
 <b>Male thread</b>	3/8" BSP 1/2" BSP 3/4" BSP	IB11NMC3 IB11NMC4 —	IBS11CCMC3 IBS11CCMC4 IBS11CCMC6	 <b>Male thread</b>	3/8" NPT 1/2" NPT 3/4" NPT	23904-310. 23904-410 — 23204-014 23204-015
 <b>Female thread</b>	3/8" BSP 1/2" BSP 3/4" BSP	IB11NFC3 IB11NFC4 —	IBS11CCFC3 IBS11CCFC4 IBS11CCFC6	 <b>Female Thread</b>	3/8" NPT 1/2" NPT 3/4" NPT	23904-003 23904-400. — 23204-400. 23204-005
 <b>For hose</b>	10 mm 13 mm 16 mm 19 mm	IB11NH10 IB11NH13 IB11NH16 IB11NH19	IBS11CCH10 IBS11CCH13 IBS11CCH16 IBS11CCH19	 <b>For hose</b>	13 mm 19 mm	23904-520. — 23204-025 23204-026

(1) Measured at 6 bar (87 psig) at inlet, with 10% pressure drop as per industry standard.









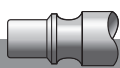

# Quick Release Couplings & Nipples









## EURO 7.2 - 7.4 Profile

									
Bore Ø 7.2 - 7.4 mm		Nipple (BSP)		Push-pull regular coupling Grey body		Push-pull safety coupling Black body		Button / safety coupling Black body/blue button	
<b>16 bar max. – Flow 25 l/s<sup>(1)</sup></b>									
	Male thread	1/4" BSP	77NMC2	7N7CCMC2	757CCMC2	757CMC2			
		3/8" BSP	77NMC3	7N7CCMC3	757CCMC3	757CMC3			
		1/2" BSP	77NMC4	7N7CCMC4	757CCMC4	757CMC4			
	Female thread	1/4" BSP	77NFC2	7N7CCFC2	757CCFC2	757CFC2			
		3/8" BSP	77NFC3	7N7CCFC3	757CCFC3	757CFC3			
		1/2" BSP	77NFC4	7N7CCFC4	757CCFC4	757CFC4			
	For hose	Ø 6 mm	77NH06	7N7CCH06	757CCH06	—			
		Ø 8 mm	77NH08	7N7CCH08	757CCH08	757CH08			
		Ø 10 mm	77NH10	7N7CCH10	757CCH10	757CH10			
		Ø 13 mm	77NH13	7N7CCH13	757CCH13	757CH13			

## ARO Profile

											
Bore Ø 6 mm (1/4")		Nipple (BSP)		Button / regular coupling (BSP) Grey body/gold button		Button / safety coupling (BSP) Black body/yellow button		Nipple (NPT)		Regular coupling (NPT) Steel	
<b>12 bar max. – Flow 17 l/s (standard) - 13 l/s (safety)<sup>(1)</sup></b>											
	Male thread	1/4"	AN6CMC2	AN6CMC2	AS6CMC2	2608	210-212.				
		3/8"	AN6CMC3	AN6CMC3	AS6CMC3	—	210-213.				
		1/2"	—	AN6CMC4	AS6CMC4	—	—				
	Female thread	1/4"	AN6CMFD2	AN6CFC2	AS6CFC2	2609.	210-B				
		3/8"	AN6CMF3	AN6CFC3	AS6CFC3	—	—				
		1/2"	—	AN6CFC4	AS6CFC4	—	—				
	For hose	6 mm	AN6CH06	AN6CH06	AS6CH06	39046.	210-022.				
		8 mm	AN6CH08	AN6CH08	AS6CH08	39047.	—				
		10 mm	AN6CH10	AN6CH10	AS6CH10	22238	210-215.				

## 1300/1800 Profile

									
		Nipple (BSP)		Regular coupling Steel		Nipple (BSP)		Regular coupling Steel	
<b>30 bar max. – Flow 23 l/s<sup>(1)</sup></b>					<b>30 bar max. – Flow 61 l/s<sup>(1)</sup></b>				
	Male thread	1/4" BSP	13210N	—	1/4" BSP	18110	—		
		3/8" BSP	13220	1300A	3/8" BSP	18210N	—		
		1/2" BSP	13410	1300	1/2" BSP	18220	1800A		
	Female thread	1/4" BSP	—	1300B	3/4" BSP	18230	—		
		3/8" BSP	—	—	1/4" NPT	18405	—		
		6 mm	13006	1300 + 1306 <sup>(2)</sup>	3/8" NPT	18410	1800		
	For hose	8 mm	13008	1300 + 1308 <sup>(2)</sup>	1/2" NPT	—	1800B		
		10 mm	13010	1300 + 1310 <sup>(2)</sup>	3/4" NPT	—	1800C		
		12 mm	13012	1300 + 1312 <sup>(2)</sup>	6 mm	18006	—		
					8 mm	18008	—		
					10 mm	18010	1800 + 1810 <sup>(2)</sup>		
					12 mm	18012	1800 + 1812 <sup>(2)</sup>		
				16 mm	18016	1800 + 1816 <sup>(2)</sup>			
				19 mm	18019	1800 + 1819 <sup>(2)</sup>			

(1) Measured at 6 bar (87 psig) at inlet, with 10% pressure drop as per industry standard.  
 (2) Nipples to allow installation of a coupling onto a hose (see illustration above).

# Hoses - Mufflers - Blow Guns

## Recoil Hoses & Hose Coils

The Ingersoll Rand line of hoses are pressure rated for optimised pneumatic performance, even in the toughest shop environments and applications.

### Polyurethane Recoil Hoses

Part no.	Hose int. diameter (mm)	Male fittings: NPT thread (in)	Hose length (m)	Working length (m)	Compact length (m)
<b>Yellow Hose</b>					
34102	6	1/4	3	2.5	0.15
34202	6	1/4	6	5	0.31
34302	6	1/4	9	8	0.43
35102	8	1/4	3	2.5	0.14
35202	8	1/4	6	5	0.30
35302	8	1/4	9	8	0.46
IR36103	9.5	1/4	3	2.5	0.15
IR36203	9.5	1/4	6	5	0.34
IR36303	9.5	1/4	9	8	0.52
IR36102	9.5	3/8	3	2.5	0.15
IR36202	9.5	3/8	6	5	0.34
IR36302	9.5	3/8	9	8	0.52
IR37102	13	1/2	3	2.5	0.16
IR37202	13	1/2	6	5	0.38
<b>Blue Hose</b>					
IR36713	9.5	3/8	6	5	0.34
IR36715	9.5	3/8	9	7.5	0.52

\* Temperature range -40 to +38°C. Operating pressure 8 bar at 24°C.

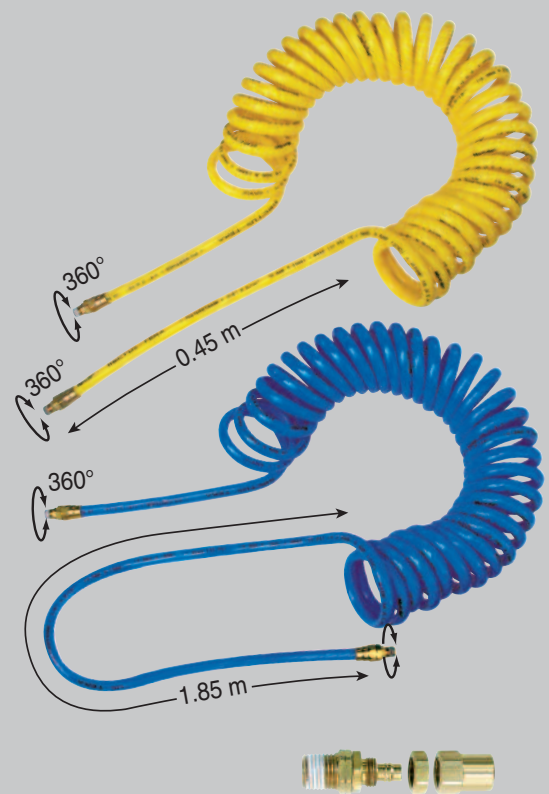

### Fittings Kits for Polyurethane Hoses

Part no.	Thread size (in)	Hose internal Ø (mm)
06368	1/4	6
06369	1/4	8
06370	3/8	9.5
06372	1/2	13

### Nylon Recoil Hoses

Part no.	Hose int. diameter (mm)	Male fittings: NPT thread (in)	Hose length (m)	Working length (m)	Compact length (m)
<b>Red Hose</b>					
12-20301	6	1/4	3.5	3.0	0.15
12-20302	6	1/4	7.5	6.5	0.31
33130	6	Without fittings	30	27	1.15
12-20307	8	1/4	3.5	3.0	0.15
12-20308	8	1/4	7.5	6.5	0.23
12-20313	9.5	1/4	3.5	3.0	0.13
12-20314	9.5	3/8	3.5	3.0	0.13
12-20319	9.5	3/8	7.5	6.0	0.25
33230	9.5	Without fittings	30	26	0.97
12-20324	13	1/2	3.5	2.7	0.13
12-20325	13	1/2	7.5	5.5	0.23
33330	13	Without fittings	30	23	0.89
33410	19.5	3/4	7.5	5.2	0.23
12-20332	19.5	3/4	15	10.7	0.41
33430	19.5	Without fittings	30	21.5	0.79
33530	25.4	Without fittings	30	19.8	0.87

\* Temperature range -25 to +75°C. Operating pressure 13 bar at 20°C.

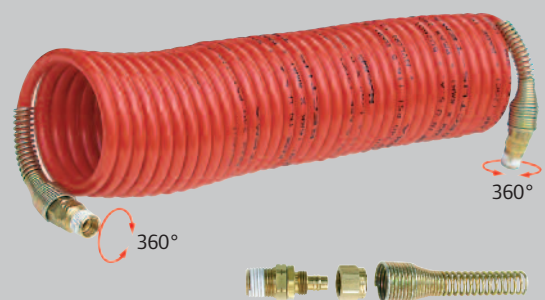

### Fittings Kits for Nylon Hoses

Part no.	Thread size (in)	Hose internal Ø (mm)
33002	1/4	6
330025	1/4	8
33008	1/4	9.5
33003	3/8	9.5
33004	1/2	13
33005	3/4	19.5
33006	3/4	25.4
33007	1	25.4

# Hoses - Mufflers - Blow Guns



## High Quality PVC Round Hose, 30 m Coil

- Scuff resistant outer cover – great kink resistance.
- Lightweight and ultra flexible.
- Resistance against a wide range of chemicals.
- Temperature range from -20 to +65°C.



Part no.	Internal diameter (mm)	External diameter (mm)	Burst pressure (bar)	Working pressure at 20°C * (bar)
RH-6	6	11	74	18
RH-8	8	13	65	15
RH-10	10	14	54	13
RH-12	13	17	44	11
RH-16	16	21	44	11
RH-19	19	24	44	11

\* Safety factor 4:1.

## Mufflers

- Effective sound attenuation for low noise level.
- Low back pressure provides minimal power loss.



3BM-WM07

3BM-A674

150BM-A674



SS350-A674

ST500-674

SS800-A674

Part no.	NPT thread (in)	Flow capacity	Body diameter (mm)	Overall length (mm)
MRV003A010-RP	1/8	Medium	54	36
MRV015A010-RP	1/4	High	64	40
MRV040A010-RP	1/2	Medium	79	52
MOV010AA-674	1/2	High	68	87
3BM-WM07	3/4	Medium	182	56
3BM-A674	1	High	220	98
150BM-A674	1 1/4	High	107	85
SS350-A674	1 1/2	High	116	84
ST500-674	2	Medium	122	70
SS800-A674	2 1/2	High	169	121



## Hose Whips

Part no.	Thread size (in)	Hose length (mm)
33104	1/4 NPT	300
33204	3/8 NPT	300
33304	1/2 NPT	300

## Hose Clamps



Part no.	Hose external diameter (mm)	Packing quantity (mm)
CO-0911	9-11	100
CO-1113	11-13	100
CO-1315	13-15	100
CO-1518	15-18	100
CO-1821	18-21	100
CO-2225	22-25	100

## Safety Blow Guns

### Part no. 94053

Brass air screen tip produces conical air stream around direct centre air stream – minimises blow-back of chips or particles. Maximum air pressure 6-7 bar. 1/4" BSP inlet. Weight 200 gr.



### Part no. 94054

For use with blow pipes only. Maximum air pressure 6-7 bar. 1/4" BSP inlet. Weight 190 gr.

- Blow pipe, 150 mm long, part no. 94055
- Blow pipe, 450 mm long, part no. 94056

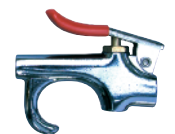

### Part no. 94057

One piece, die cast construction. Tamper-proof vent holes increase total air flow. Maximum air pressure 6-7 bar. 1/4" BSP inlet. Weight 190 gr.

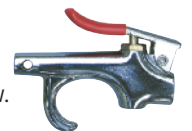

### Part no. 94058

Safety blow gun in composite material with built-in blow pipe. Maximum air pressure 10 bar. 1/4" BSP inlet. Maximum air flow 6.4 l/s



# Tool Accessories

Featuring ergonomic accessories including balancers and torque arms, attachments and consumables.



**21-23** Spring Balancers

**24-25** Torque Reaction Arms

**26-32** Impact Sockets & Accessories

**33-35** Pneumatic Tools Steels

**35-37** Surface Preparation Accessories

**38-39** Product Specific Accessories

**40-41** Torque Control Equipment

**42** Tool Lubricants



## B Series Spring Balancers

B Series spring balancers are designed to increase productivity in any situation where repetitive or prompt vertical movement of fixed load is required. They compensate weight of your power tools or other manufacturing equipment and enable operator to lift or lower it with minimal effort.

Series BIDS, BHD and BSD(L) feature "Zero Gravity" effect allowing virtually effortless load repositioning all along cable travel. Experience the effect of your tool floating.

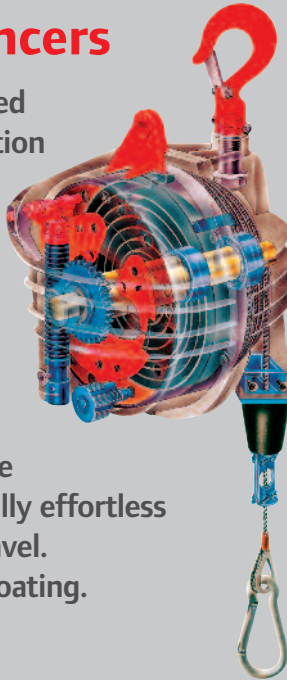



Spring Balancers

## Balancers Product Information

Standard equipment / Series	BHR Series	BLD Series	BMD Series	BIDS Series	BHD Series	BSD(L) Series
Stainless steel cable and anti-friction cable guide	●	●	●	●	●	●
Auxiliary safety suspension	●	●	●	●	●	●
Adjustable stroke limiting device	●	●	●	●	●	●
Inert spring drum assembly	●	●	●	●	●	●
Adjustable capacity (by means of a worm screw for BIDS, BHD and BSD Series)	●	●	●	●	●	●
Rotary load hook	–	–	–	Option: OPTRI		
Automatic safety brake acting in case of spring breakage	–	–	●	●	●	●
Rotary upper suspension with safety hook on ball bearing	–	–	–	●	●	●
Locking device to block the load at any height	–	–	● / –	●	●	●
Tapered drum rotating on ball bearings for zero gravity effect	–	–	–	●	●	●
Optional floor control locking	–	–	–	–	Part no. BIL-7343	Part no. BIL-3224

## BHR Hose Reel Balancers Series

Part no.		SWL (kg)	Lifting stroke (m)	 (kg)	Replacement parts:	
					Spring	Hose
<b>BHR-8</b>	1/4"	0.4 - 0.8	1.3	1.5	BIL-333	BIL-291
<b>BHR-15</b>	1/4"	0.7 - 1.5	1.3	1.5	BIL-341	BIL-291
<b>BHR-25</b>	1/4"	1.2 - 2.5	1.3	1.5	BIL-358	BIL-291

BIL-457 - replacement rubber stop.

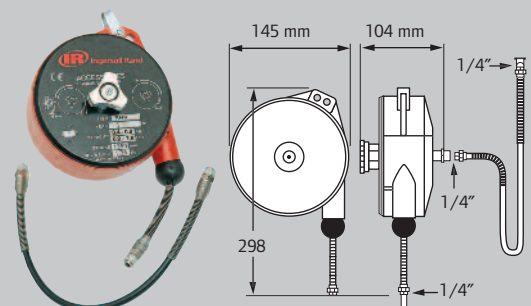

# Spring Balancers

Light to Heavy-Duty Cable Balancers,  
from 0.4 kg to 65 kg Capacity



Part no.	SWL (kg)	Max. stroke (m)	(kg)	Replacement parts:		
<b>BLD Series – Light-Duty</b>				<b>Cable (2)</b>	<b>Latch</b>	<b>Spring</b>
BLD-1	0.4 - 1.0	1.6	0.6	BIL-463	BIL-7133	BIL-131
BLD-2	1.0 - 2.0	1.6	0.6	BIL-463	BIL-7133	BIL-1206
BLD-3	2.0 - 3.0	1.6	0.7	BIL-463	BIL-7133	BIL-9887
<b>BMD Series – Medium-Duty</b>				<b>Cable (2)</b>	<b>Latch</b>	<b>Spring</b>
BMDS-2	1.0 - 2.5	2.0	2.0	BIL-0352	BIL-214	BIL-0345
BMDS-4	2.0 - 4.0	2.0	2.0	BIL-0352	BIL-214	BIL-3422
BMDS-6	4.0 - 6.0	2.0	2.3	BIL-0352	BIL-214	BIL-3430
BMDS-8	6.0 - 8.0	2.0	2.5	BIL-0352	BIL-214	BIL-3448
BMDLN-4	2.0 - 4.0	2.5	2.9	BIL-70253	BIL-20115	BIL-74065
BMDLN-6	4.0 - 6.0	2.5	3.2	BIL-70253	BIL-20115	BIL-74066
BMDLN-8	6.0 - 8.0	2.5	3.5	BIL-70253	BIL-20115	BIL-74067
BMDLN-10	8.0 - 10	2.5	3.7	BIL-70253	BIL-20115	BIL-74068
BMDLN-12	10.0 - 14	2.5	4.0	BIL-70253	BIL-20115	BIL-74069
BMDLLN-4 (1)	2.0 - 4.0	2.5	3.0	BIL-70253	BIL-20115	BIL-74070
BMDLLN-6 (1)	4.0 - 6.0	2.5	3.3	BIL-70253	BIL-20115	BIL-74071
BMDLLN-8 (1)	6.0 - 8.0	2.5	3.6	BIL-70253	BIL-20115	BIL-74072
BMDLLN-10 (1)	8.0 - 10	2.5	3.8	BIL-70253	BIL-20115	BIL-74073
<b>BIDS Series – Intermediate-Duty</b>				<b>Cable (2)</b>	<b>Latch</b>	<b>Spring</b>
BIDS-7	4.0 - 7.0	2.0	5.0	BIL-9999	BIL-20115	BIL-9993
BIDS-10	7.0 - 10	2.0	5.5	BIL-9999	BIL-20115	BIL-9994
BIDS-14	10 - 14	2.0	5.5	BIL-9999	BIL-20115	BIL-9995
BIDS-18	14 - 18	2.0	6.5	BIL-9999	BIL-20115	BIL-9996
BIDS-22	18 - 22	2.0	6.0	BIL-9999	BIL-20115	BIL-9997
BIDS-26	22 - 25	2.0	6.6	BIL-9999	BIL-20115	BIL-10019
<b>BHD Series – Heavy-Duty</b>				<b>Cable with hook (2)</b>	<b>Drum</b>	
BHD-15	10 - 15	2.0	10.3	BIL-3652	BIL-7527	
BHD-20	15 - 20	2.0	10.6	BIL-3652	BIL-7535	
BHD-25	20 - 25	2.0	11.2	BIL-3652	BIL-7543	
BHD-30	25 - 30	2.0	11.5	BIL-3652	BIL-7550	
BHD-35	30 - 35	2.0	11.8	BIL-3652	BIL-7568	
BHD-45	35 - 45	2.0	12.4	BIL-3652	BIL-7576	
BHD-55	45 - 55	2.0	12.5	BIL-3652	BIL-7584	
BHD-65	55 - 65	2.0	13.6	BIL-3652	BIL-7592	

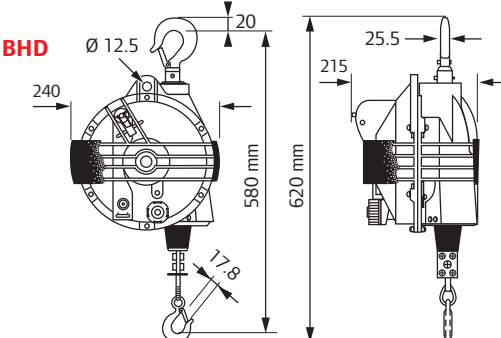
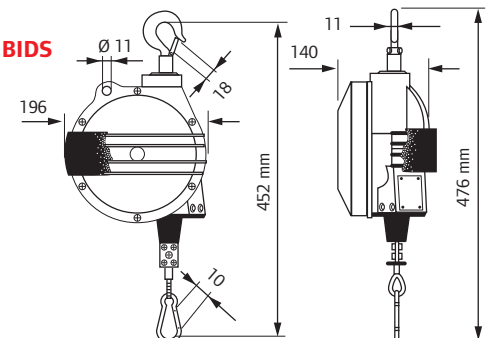
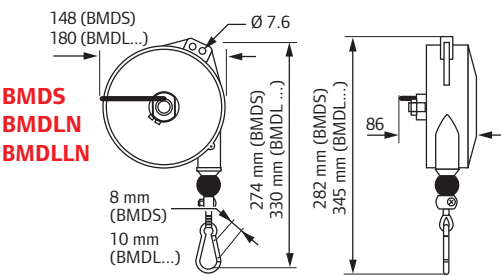
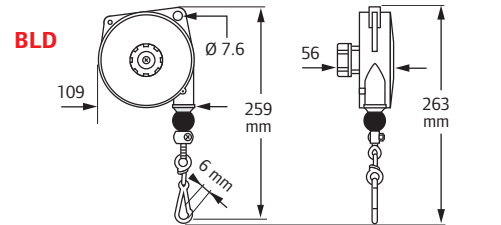

(1) Locking type balancer: sharp pull on the wire rope will lock it in position allowing attached load to be manipulated freely – without weight compensation. Pulling again will unlock the wire rope and resume weight compensation.  
 (2) Cables supplied complete with hook (BHD), clamp & rubber stop – replacement rubber stop is BIL-402 for BMD, BIL-10012 for BIDS, or BIL-669 for BHD.



BSD-165

## Super-Duty Cable Balancers, from 15 kg to 180 kg Capacity

Part no.	SWL (kg)	Max. stroke (m)	(kg)	Replacement parts:	
				Cable with hook	Drum
<b>BSD &amp; BSDL Series – Super-Duty</b>					
<b>BSD-20</b>	15 - 20	2.5	19.0	BIL-3694	BIL-0301
<b>BSD-30</b>	20 - 30	2.5	19.8	BIL-3694	BIL-0309
<b>BSD-40</b>	30 - 40	2.5	20.8	BIL-3694	BIL-9949
<b>BSD-50</b>	40 - 50	2.5	23.9	BIL-3694	BIL-9907
<b>BSD-60</b>	50 - 60	2.5	25.4	BIL-3694	BIL-9919
<b>BSD-70</b>	60 - 70	2.5	26.8	BIL-3694	BIL-0012
<b>BSD-80</b>	70 - 80	2.5	27.8	BIL-3694	BIL-0020
<b>BSD-90</b>	80 - 90	2.5	28.8	BIL-3694	BIL-0046
<b>BSD-100</b>	90 - 100	2.5	35.6	BIL-3694	BIL-0046
<b>BSD-120</b>	100 - 120	2.5	38.8	BIL-3694	BIL-0285
<b>BSD-140</b>	120 - 140	2.5	41.8	BIL-3694	BIL-0293
<b>BSD-150</b>	130 - 150	2.5	44.5	BIL-3694	BIL-0145
<b>BSD-165</b>	150 - 165	2.5	48.2	BIL-3694	BIL-0152
<b>BSDL-20</b>	15 - 20	3.0	19.1	BIL-3751	BIL-9923
<b>BSDL-25</b>	20 - 25	3.0	19.9	BIL-3751	BIL-9931
<b>BSDL-35</b>	25 - 35	3.0	20.9	BIL-3751	BIL-9949
<b>BSDL-45</b>	35 - 45	3.0	23.8	BIL-3751	BIL-0053
<b>BSDL-50</b>	40 - 50	3.0	23.9	BIL-3751	BIL-0061
<b>BSDL-60</b>	50 - 60	3.0	25.3	BIL-3751	BIL-0079
<b>BSDL-70</b>	60 - 70	3.0	26.7	BIL-3751	BIL-0012
<b>BSDL-80</b>	70 - 80	3.0	28.0	BIL-3751	BIL-0020
<b>BSDL-90</b>	80 - 90	3.0	29.0	BIL-3751	BIL-0103
<b>BSDL-100</b>	90 - 100	3.0	36.8	BIL-3751	BIL-0111
<b>BSDL-115</b>	100 - 115	3.0	38.7	BIL-3751	BIL-0178
<b>BSDL-130</b>	115 - 130	3.0	39.9	BIL-3751	BIL-0186
<b>BSDL-140</b>	130 - 140	3.0	42.8	BIL-3751	BIL-0293
<b>BSDL-150</b>	140 - 150	3.0	45.6	BIL-3751	BIL-0145
<b>BSDL-180</b>	160 - 180	3.0	50.0	BIL-3751	BIL-0228

### BSD-20 to BSD-60 and BSDL-20 to BSDL35

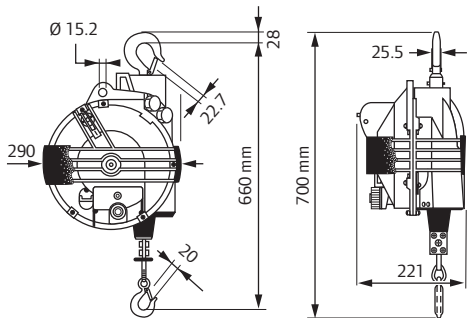

### BSD-70 to BSD-100 and BSDL-45 to BSDL-100

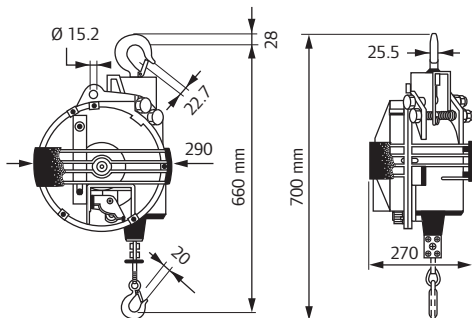

### BSD-120 to BSD-165 and BSDL-115 to BSDL-180

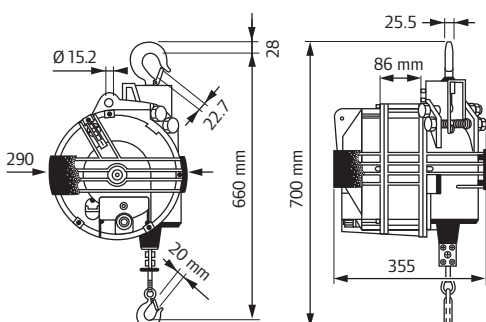

All cables come complete with hook (BIL-701), rubber stop (BIL-3124) and clamp.

## Options & Accessories

Locking / unlocking device for control from the floor:

Part no. **BIL-7343** (for BHD Series).

Part no. **BIL-3224** (for BSD and BSDL Series)

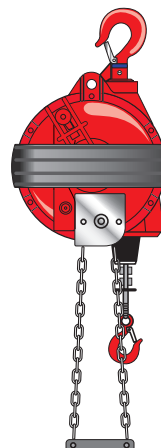

For rotating bottom hook, please order Part no. **OPTRI** to install it on BIDS balancers.

For BHD and BSD(L) Series, amend balancer part number with "OPTRI"

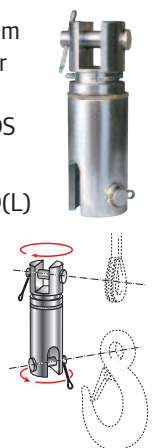

# Torque Reaction Arms

## Bench-Mounted Arms

Ingersoll Rand QTA bench-mounted torque reaction arms are constructed of lightweight aluminium and are available in a variety of torque capacities, ranging from 10 to 150 Nm. They include an Ingersoll Rand spring-loaded, die-cast aluminium balancer for impressive strength and reduced weight.

Floor mount position



The QTA150 can be easily configured as either a bench-mounted or floor-mounted torque arm, and reconfigured as the job demands.

Bench mount position

Spring balancer adjusts easily and offers effortless vertical movement.

Simple, proven design for trouble-free setup and dependability.

Anodised aluminium body delivers toughness in a lightweight design.

Multiple-tool holder options include right angle, swivel, and pistol grip. Custom tool holder options enable seamless integration with Ingersoll Rand QA and QE tools.

Chrome-plated pole paired with a self-lubricating bearing, provides unmatched durability.

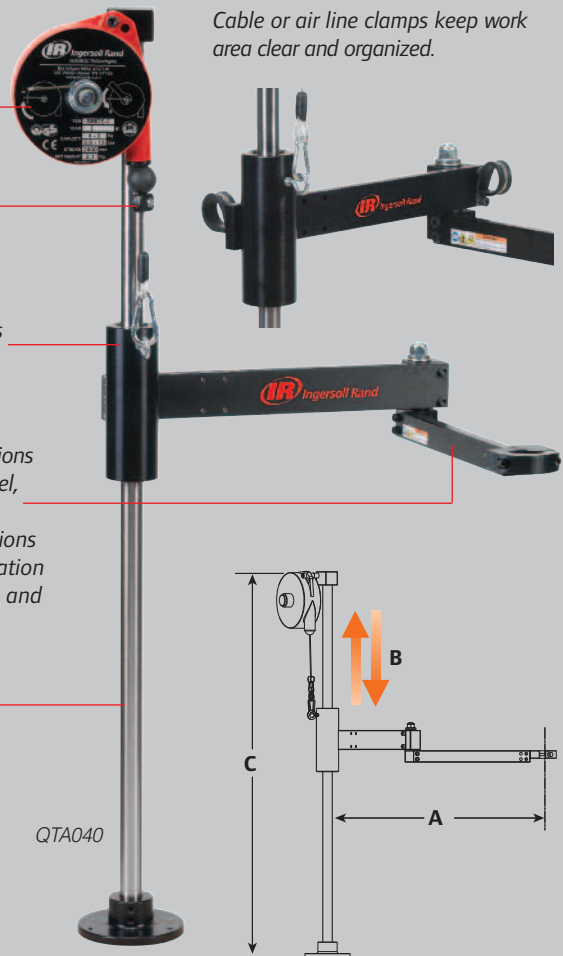

Cable or air line clamps keep work area clear and organized.

QTA040

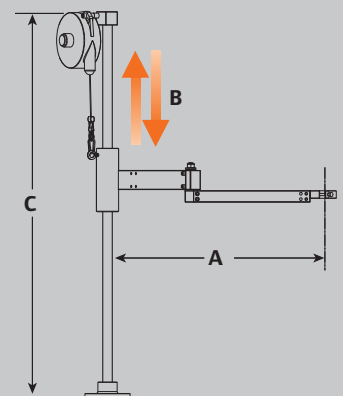

## Arm Specifications

Part no.	Max. torque (Nm)	Tool weight (kg)	Dimensions (mm)		
			A	B	C
<b>Bench-Mount Torque Arms</b>					
QTA010	10	1.2	380	330	706
QTA020	20	2.3	508	368	808
QTA040	40	3.0	635	445	1008
QTA100	100	3.6	762	445	1008
QTA150	150	4.5	1321	559	2000

## Bench-Mounted Arm Accessories



Inverse mounting kit

Upper pole clamp

Torque arm accessories include inverse mounting kits to provide mounting to overhead structure and upper pole clamps that help limit travel of the bearing and add support to the top of the arm. Use the table below to select the proper accessory for each torque arm.

## Generic Clamp Style Tool Holders



Tool type	QTA010	QTA020	QTA040	QTA100
● Inline (included)	ITC010-1C	ITC040-1C	ITC040-1C	-
① Right Angle	ATC010-1C	ATC040-1C	ATC040-1C	ATC100-1C
② Pistol	PTC010-1C	PTC040-1C	PTC040-1C	-
③ Rotating	RTC010-1C	RTC040-1C	RTC040-1C	-
④ 1/4" NPT	NTC010-1T	-	-	-

Generic tool holders are available for arms up to 100 Nm (these arms are delivered with an inline tool holder as standard). Flange mounting is recommended for inline tools with torque capacity above 40 Nm. Please note the tool diameter range for generic holders: QTA010: 25 – 40 mm, QTA020 / QTA040 / QTA100: 28 – 52 mm.

Accessory	Compatible torque arm			
	QTA010	QTA020	QTA040	QTA100
Inverse mounting kit	IMK010	IMK020	IMK100	IMK100
Upper pole clamp	PUC010	PUC020	PUC100	PUC100



# Torque Reaction Arms

## Floor-Mounted Arms

When high-torque fastening is required, Ingersoll Rand has two floor-mounted, air-enabled arms from which to choose, with 270 Nm and 475 Nm capacities.

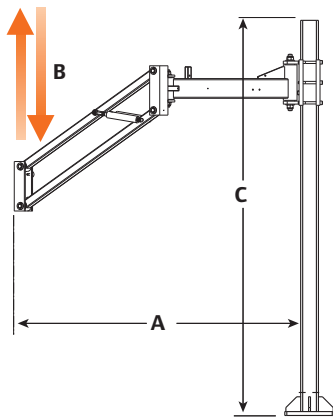

Generous arm length makes QTA ideal for assembly line applications.

Adjustable height control delivers flexibility for virtually any application.



Safety stop eliminates over-extending arms.

Custom tool holder options permit use with Ingersoll Rand QA and QE tools.

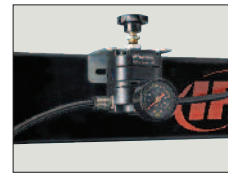

QTA270

Ingersoll Rand air regulator included with QTA270 and QTA475 arms.

Simple design ensures easy, effective setup and use.

Solid, steel-frame construction for rugged dependability

Torque Arms

## Arm Specifications

Part no.	Max. torque (Nm)	Tool weight (kg)	Dimensions (mm)		
			A	B	C
<b>Floor-Mount Torque Arms</b>					
QTA270	270	10	1524	477	2000
QTA475	475	23	2007	590	2000



## Ingersoll Rand QA Series and QE Series Tool Holders for Bench- and Floor-mounted Arms

Tool type	QTA010	QTA020	QTA040	QTA100	QTA150	QTA270	QTA475
QE4 (non-push to start)	-	CTC040-K1B	CTC040-K1B	-	-	-	-
QE4 (push to start)	CTC040-K1P	CTC040-K1P	CTC040-K1P	-	-	-	-
QE6 (with bolt-on flange GEM120-K48 installed)	-	CTC040-K2B	CTC040-K2B	CTC100-K2B	-	-	-
QE8 (with bolt-on flange GEM120-K48 installed)	-	-	-	CTC100-K2B	CTC150-K2B	-	-
QE8 (with integrated flanged gear case)	-	-	-	CTC100-K3B	CTC150-K3B	CTC270-K3B	-
QE8 (230 Nm inline)	-	-	-	-	-	CTC270-K4B	-
QE8 (400 Nm angle)	-	-	-	-	-	-	CTC475-K5B
QA4 (27 Nm max inline) & QA6	-	CTC040-K1B	CTC040-K1B	CTC100-K1B	-	-	-
QA4 (46 Nm inline with GEM120-K48 flange)	-	-	-	CTC100-K2B	-	-	-
QA8 (max 150 Nm angle, max 55 Nm inline)	-	-	CTC040-K1B	CTC100-K1B	CTC150-K2B	-	-
QA8 (>150 Nm angle, >55 Nm inline)	-	-	-	CTC100-K2B	CTC150-K3B	CTC270-K3B	-

**Note:** Every Ingersoll Rand QE- or QA-specific tool holder listed in the table above accepts both angle and inline tools but requires an integrated flanged gear case or bolt-on mounting flange to attach the tool holder to the tool.

If your tool came with mounting style P (with letter "P" in the part number) order part no. 15E4-K48 for any Ingersoll Rand specific tool holder that ends with "1B". Order part no. GEM120-K48 for any Ingersoll Rand specific tool holder that ends with "2B".

# Metric Impact Sockets

## Sockets Features

Genuine Ingersoll Rand impact sockets are built of top quality materials for performance and durability.

Specifically designed for use with Ingersoll Rand power tools, our sockets are the perfect solution for your everyday tightening and loosening applications.

Impact-grade toughness – designed for high-torque applications.

Forged chrome-molybdenum steel for high-strength durability.



Electro-phosphate finish on 1/4 to 1" drive sizes – projects a sleek look and high visibility.

Laser-etched socket size labelling for easy size identification.

Backed by a Lifetime Warranty from manufacturing and material defects. Some special sockets and large to small drive adapters are excluded from the lifetime warranty - see your supplier for details.

**1/4"**

## Square Drive Sockets

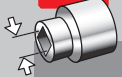

A/F	Part no.	T (mm)	L (mm)	D1 (mm)	D2 (mm)	Shape
	<b>Standard Sockets</b>					
4 mm	S62M4	5	23	7.6	13	A
4.5 mm	S62M45	5	23	8.2	13	A
5 mm	S62M5	5	23	8.8	13	A
5.5 mm	S62M55	5	23	9.5	13	A
6 mm	S62M6	7	23	10	13	A
7 mm	S62M7	7	23	11.3	13	A
8 mm	S62M8	7	23	12.5	13	A
9 mm	S62M9	7	23	14	14	B
10 mm	S62M10	7	23	14.5	14.5	B
11 mm	S62M11	8	23	17	17	B
12 mm	S62M12	8	23	18	18	B
13 mm	S62M13	8	23	19	19	B
14 mm	S62M14	8	23	20	20	B

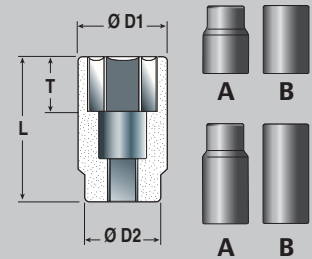

### Socket Set, part no. SK2M12

1/4" square drive socket set – contains: 6, 7, 8, 9, 10, 11, 12, 13, 14 mm standard sockets, 50 mm extension, 100 mm extension and 3/8" female to 1/4" male adapter.



**3/8"**

## Square Drive Sockets

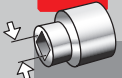

A/F	Part no.	T (mm)	L (mm)	Part no.	T (mm)	L (mm)	D1 (mm)	D2 (mm)	Shape
	<b>Standard Sockets</b>			<b>Deep Sockets</b>			<b>Common Features</b>		
7 mm	S63M7	7	28	S63M7L	11	63	11.5	19	A
8 mm	S63M8	7	28	S63M8L	12	63	12.5	19	A
9 mm	S63M9	7	28	S63M9L	14	63	14	19	A
10 mm	S63M10	7	28	S63M10L	14	63	15	19	A
11 mm	S63M11	7	30	S63M11L	17	63	17	19	A
12 mm	S63M12	7	30	S63M12L	17	63	18	19	A
13 mm	S63M13	7	30	S63M13L	17	63	19	19	B
14 mm	S63M14	7	30	S63M14L	17	63	20	20	B
15 mm	S63M15	10	30	S63M15L	19	63	22	22	B
16 mm	S63M16	10	30	S63M16L	19	63	24	24	B
17 mm	S63M17	10	32	S63M17L	19	63	24	24	B
18 mm	S63M18	13	32	S63M18L	19	63	26	26	B
19 mm	S63M19	13	32	S63M19L	21	63	26	26	B
20 mm	S63M20	13	32	S63M20L	21	63	28	28	B
21 mm	S63M21	13	32	S63M21L	21	63	30	30	B
22 mm	S63M22	13	32	S63M22L	21	63	32	32	B



### Socket Set, part no. SK3M10

3/8" square drive socket set – contains 10 standard sockets: 9, 10, 11, 12, 13, 14, 15, 16, 17, 19 mm.



# Metric Impact Sockets

## 1/2" Square Drive Socket Sets

### Part no. SK4M18

Contains 9 standard sockets (10, 11, 13, 14, 17, 19, 21, 22 and 24 mm), 4 deep sockets (13, 14, 21, and 24 mm), 3 deep / thin wall sockets (17, 19 and 21 mm), 125 mm extension bar and 1/2" square drive power joint.



SK4M18

### Part no. SK4M14

Contains 14 standard sockets (10, 11, 12, 13, 14, 15, 16, 17, 18, 19, 21, 22, 23 and 24 mm).



SK4M14

### Part no. SK4M5L

Contains 5 deep sockets (17, 19, 21, 22 and 24 mm)



SK4M5L

### Part no. SK4M3L

Contains 3 deep insulated, thin wall sockets (17, 19 and 21 mm).



SK4M3L

## Special Socket Sets (in carrying case)

### Part no. SK4LNR

Indispensable tool for each tyre repair shop. Helps to remove secured nuts and bolts in case urgent tyre repair is needed – contains 8 sockets with 1/2" square drive (17, 18.5, 20, 21.5, 23, 24.5, 26 and 27.5 mm).



### Part no. SK4M7U

1/2" square drive sockets (13, 14, 15, 17, 19, 21 and 22 mm), pre-fitted on power joints – to facilitate handling nuts and bolts in areas with very limited accessibility.



## 1/2" Square Drive Sockets

A/F	Part no.	T (mm)	L (mm)	Part no.	T (mm)	L (mm)	D1 (mm)	D2 (mm)	Shape
	<b>Standard Sockets</b>			<b>Deep Sockets</b>			<b>Common Features</b>		
8 mm	S64M8	9	38	S64M8L	11	78	14	22	A
9 mm	S64M9	11	38	S64M9L	14	78	15	22	A
10 mm	S64M10	11	38	S64M10L	14	78	17	22	A
11 mm	S64M11	11	38	S64M11L	14	78	18	22	A
12 mm	S64M12	11	38	S64M12L	14	78	19	22	A
13 mm	S64M13	11	38	S64M13L	14	78	20	22	A
14 mm	S64M14	11	38	S64M14L	19	78	22	24	A
15 mm	S64M15	11	38	S64M15L	19	78	24	24	B
16 mm	S64M16	11	38	S64M16L	19	78	24	24	B
17 mm	S64M17	11	38	S64M17L	19	78	26	26	B
18 mm	S64M18	11	38	S64M18L	19	78	26	26	B
19 mm	S64M19	13	40	S64M19L	19	78	28	28	B
20 mm	S64M20	13	40	S64M20L	19	78	30	30	B
21 mm	S64M21	13	40	S64M21L	21	78	30	30	B
22 mm	S64M22	13	42	S64M22L	21	78	32	32	B
23 mm	S64M23	13	42	S64M23L	21	78	32	32	B
24 mm	S64M24	15	44	S64M24L	21	78	34	34	B
25 mm	S64M25	15	44	S64M25L	21	78	35	35	B
26 mm	S64M26	15	44	S64M26L	21	78	36	36	B
27 mm	S64M27	18.3	46	S64M27L	21	78	38	38	B
28 mm	S64M28	18.3	46	S64M28L	24	78	40	38	C
29 mm	S64M29	18.3	46	S64M29L	24	78	40	38	C
30 mm	S64M30	18.3	46	S64M30L	24	78	42	38	C
32 mm	S64M32	18.3	46	S64M32L	24	78	44	38	C
33 mm	S64M33	20	46	S64M33L	24	78	45	38	C
34 mm	S64M34	20	46	S64M35L	24	78	48	38	C
36 mm	S64M36	20	50	S64M36L	24	78	50	38	C

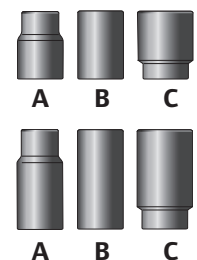
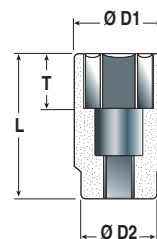

# Metric Impact Sockets

## **3/4"** Square Drive Socket Set



**Part no. SK6M6L**  
Contains 6 deep sockets (24, 27, 30, 32, 33 and 36 mm).

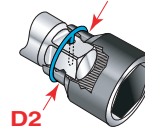

See retaining ring specifications on page 32

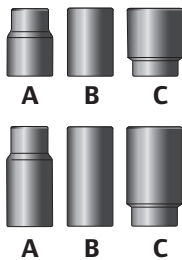
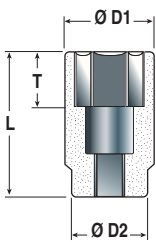

## **3/4"** Square Drive Sockets

A/F	Part no.	T (mm)	L (mm)	Part no.	T (mm)	L (mm)	D1 (mm)	D2 (mm)	Shape	Recommended retaining ring
	<b>Standard Sockets</b>			<b>Deep Sockets</b>			<b>Common Features</b>			
17 mm	S66M17	13	51	S66M17L	19	90	30	44	A	RR10034S
18 mm	S66M18	13	51	-	-	-	31	44	A	RR10034S
19 mm	S66M19	13	51	S66M19L	19	90	32.5	44	A	RR10034S
20 mm	S66M20	13	51	S66M20L	19	90	33.5	44	A	RR10034S
21 mm	S66M21	13	51	S66M21L	19	90	35	44	A	RR10034S
22 mm	S66M22	13	51	S66M22L	19	90	36	44	A	RR10034S
23 mm	S66M23	13	51	S66M23L	19	90	37.5	44	A	RR10034S
24 mm	S66M24	16	51	S66M24L	19	90	38.5	44	A	RR10034S
25 mm	S66M25	16	53	S66M25L	19	90	40	44	A	RR10034S
26 mm	S66M26	16	53	S66M26L	22	90	41	44	A	RR10034S
27 mm	S66M27	16	53	S66M27L	22	90	42.5	44	A	RR10034S
28 mm	S66M28	19	53	S66M28L	22	90	44	44	B	RR10034S
29 mm	S66M29	19	53	S66M29L	22	90	45	44	C	RR10034S
30 mm	S66M30	19	53	S66M30L	22	90	46	44	C	RR10034S
31 mm	S66M31	19	57	S66M31L	22	90	47.5	44	C	RR10034S
32 mm	S66M32	19	57	S66M32L	22	90	48.5	44	C	RR10034S
33 mm	S66M33	22	57	S66M33L	25	90	50	44	C	RR10034S
34 mm	S66M34	22	57	S66M34L	25	90	51	44	C	RR10034S
35 mm	S66M35	22	57	S66M35L	25	90	52.5	44	C	RR10034S
36 mm	S66M36	22	57	S66M36L	25	90	53.5	44	C	RR10034S
37 mm	S66M37	22	57	-	-	-	55	44	C	RR10034S
38 mm	S66M38	22	57	S66M38L	25	90	56	44	C	RR10034S
40 mm	S66M40	22	58	S66M40L	30	90	58.5	44	C	RR10034S
41 mm	S66M41	22	58	S66M41L	30	90	60	44	C	RR10034S
42 mm	S66M42	25	58	S66M42L	30	90	61	44	C	RR10034S
43 mm	S66M43	25	62	S66M43L	30	90	62.5	44	C	RR10034S
46 mm	S66M46	25	62	S66M46L	30	90	66	44	C	RR10034S
50 mm	S66M50	30	68	S66M50L	30	90	71	44	C	RR10034S

# Metric Impact Sockets

## 1" Square Drive Socket Set



**Part no. SK8M4L**  
Contains 4 deep sockets (27, 30, 32 and 33 mm).

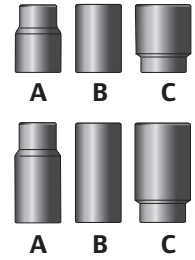
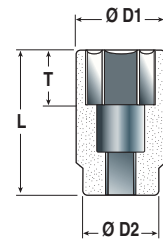

## 1" Square Drive Sockets

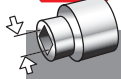

A/F	Part no.	T (mm)	L (mm)	Part no.	T (mm)	L (mm)	D1 (mm)	D2 (mm)	Shape	Recommended retaining ring
	<b>Standard Sockets</b>			<b>Deep Sockets</b>			<b>Common Features</b>			
19 mm	S68M19	17	58	S68M19L	25	90	35	54	A	RR10015S
21 mm	S68M21	17	58	S68M21L	25	90	37.5	54	A	RR10015S
22 mm	S68M22	17	58	S68M22L	25	90	39	54	A	RR10015S
23 mm	S68M23	17	58	S68M23L	25	90	40	54	A	RR10015S
24 mm	S68M24	17	58	S68M24L	25	90	41.5	54	A	RR10015S
25 mm	S68M25	17	60	S68M25L	25	90	42.5	54	A	RR10015S
26 mm	S68M26	17	60	S68M26L	25	90	44	54	A	RR10015S
27 mm	S68M27	17	60	S68M27L	25	90	45	54	A	RR10015S
28 mm	S68M28	17	60	S68M28L	25	90	46.5	54	A	RR10015S
29 mm	S68M29	19	62	S68M29L	25	90	47.5	54	A	RR10015S
30 mm	S68M30	19	62	S68M30L	25	90	49	54	A	RR10015S
32 mm	S68M32	19	63	S68M32L	25	90	51.5	54	A	RR10015S
33 mm	S68M33	21	63	S68M33L	25	90	52.5	54	A	RR10015S
34 mm	S68M34	21	63	S68M34L	25	90	54	54	B	RR10015S
35 mm	S68M35	21	66	S68M35L	25	90	55	54	C	RR10015S
36 mm	S68M36	23	66	S68M36L	25	90	56.5	54	C	RR10015S
38 mm	S68M38	23	66	S68M38L	25	90	59	54	C	RR10015S
40 mm	S68M40	23	66	S68M40L	25	90	61	54	C	RR10015S
41 mm	S68M41	25	68	S68M41L	25	90	62.5	54	C	RR10015S
42 mm	S68M42	25	68	S68M42L	25	90	64	54	C	RR10015S
45 mm	S68M45	25	70	S68M45L	30	100	67.5	54	C	RR10015S
46 mm	S68M46	29	72	S68M46L	30	100	69	54	C	RR10015S
48 mm	S68M48	29	76	S68M48L	30	100	71.5	54	C	RR10015S
50 mm	S68M50	31	76	S68M50L	30	100	74	54	C	RR10015S
52 mm	S68M52	31	80	S68M52L	30	100	76.5	54	C	RR10015S
54 mm	S68M54	31	80	S68M54L	35	108	79	54	C	RR10015S
55 mm	S68M55	34	84	S68M55L	35	108	80	54	C	RR10015S
56 mm	S68M56	34	84	S68M56L	35	108	81.5	54	C	RR10015S
58 mm	S68M58	34	84	S68M58L	35	108	84	54	C	RR10015S
60 mm	S68M60	35	88	S68M60L	35	108	86.5	54	C	RR10015S
65 mm	S68M65	35	92	S68M65L	35	120	92.5	54	C	RR10015S
70 mm	S68M70	35	96	S68M70L	35	125	99	54	C	RR10015S
75 mm	S68M75	35	102	S68M75L	35	125	105	60.3	C	RR10015S
80 mm	S68M80	35	102	S68M80L	35	125	111.5	60.3	C	RR10015S
85mm	S68M85	35	106	S68M85L	35	135	117.5	86	C	RR10025S
90 mm	S68M90	35	108	S68M90L	35	135	124	86	C	RR10025S
95 mm	S68M95	35	110	S68M95L	35	140	130	86	C	RR10025S

# Metric Impact Sockets



## 1 1/2" Square Drive Sockets

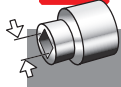

A/F	Part no.	T (mm)	L (mm)	Part no.	T (mm)	L (mm)	D1 (mm)	D2 (mm)	Shape	Recommended retaining ring
	<b>Standard Sockets</b>			<b>Deep Sockets</b>			<b>Common Features</b>			
30 mm	S612M30	21	78	—	—	—	56	86	A	RR10025S
32 mm	S612M32	22	78	—	—	—	58	86	A	RR10025S
35 mm	S612M35	22	78	—	—	—	64	86	A	RR10025S
36 mm	S612M36	24	78	—	—	—	64	86	A	RR10025S
38 mm	S612M38	26	80	—	—	—	66	86	A	RR10025S
41 mm	S612M41	28	80	S612M41L	28	115	70	86	A	RR10025S
46 mm	S612M46	30	84	S612M46L	30	115	76	86	A	RR10025S
50 mm	S612M50	32	87	S612M50L	34	135	81	86	A	RR10025S
54 mm	S612M54	37	90	S612M54L	37	140	86	86	B	RR10025S
55 mm	S612M55	37	90	S612M55L	37	140	87	86	C	RR10025S
58 mm	S612M58	39	95	—	—	—	92	86	C	RR10025S
60 mm	S612M60	39	95	S612M60L	39	150	94	86	C	RR10025S
65 mm	S612M65	42	100	S612M65L	42	150	100	86	C	RR10025S
70 mm	S612M70	46	105	S612M70L	46	160	106	86	C	RR10025S
75 mm	S612M75	49	108	S612M75L	49	170	112	86	C	RR10025S
80 mm	S612M80	53	115	S612M80L	53	170	119	86	C	RR10025S
85 mm	S612M85	56	118	S612M85L	56	170	125	86	C	RR10025S
90 mm	S612M90	59	123	S612M90L	59	170	131	86	C	RR10025S
95 mm	S612M95	61	123	S612M95L	61	180	137	95	C	RR10025S
100 mm	S612M100	65	130	S612M100L	65	190	144	95	C	RR10025S
105 mm	S612M105	68	130	S612M105L	68	190	154	95	C	RR10025S
110 mm	S612M110	72	135	S612M110L	72	200	157	95	C	RR10025S
115 mm	S612M115	77	140	S612M115L	77	210	164	95	C	RR10025S
120 mm	S612M120	77	140	S612M120L	77	210	167	95	C	RR10025S
125 mm	S612M125	77	140	—	—	—	174	127	C	RR10035S

## 2 1/2" Square Drive Sockets

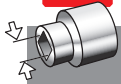

A/F	Part no.	T (mm)	L (mm)	D1 (mm)	D2 (mm)	Shape	Recommended retaining ring
	<b>Standard Sockets</b>						
75 mm	S620M75	42	140	118	127	A	RR10035SS
80 mm	S620M80	45	140	124	127	A	RR10035SS
85 mm	S620M85	52	140	130	127	B	RR10035SS
90 mm	S620M90	52	145	136	127	C	RR10035SS
95 mm	S620M95	52	145	143	127	C	RR10035SS
100 mm	S620M100	58	150	149	127	C	RR10035SS
105 mm	S620M105	58	155	155	127	C	RR10035SS
110 mm	S620M110	60	160	161	127	C	RR10035SS
115 mm	S620M115	62	165	167	127	C	RR10035SS
120 mm	S620M120	67	170	176	127	C	RR10035SS
125 mm	S620M125	72	175	184	127	C	RR10035SS
130 mm	S620M130	72	175	187	152	C	588-216 & 588-215
135 mm	S620M135	77	180	194	152	C	588-216 & 588-215
140 mm	S620M140	77	180	204	152	C	588-216 & 588-215
145 mm	S620M145	83	185	207	152	C	588-216 & 588-215
150 mm	S620M150	83	185	214	152	C	588-216 & 588-215
155 mm	S620M155	90	190	224	152	C	588-216 & 588-215
160 mm	S620M160	90	190	227	152	C	588-216 & 588-215
165 mm	S620M165	95	195	234	152	C	588-216 & 588-215
170 mm	S620M170	95	195	244	152	C	588-216 & 588-215
175 mm	S620M175	100	200	247	152	C	588-216 & 588-215
180 mm	S620M180	100	200	254	152	C	588-216 & 588-215

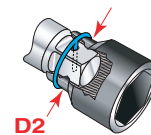

See retaining ring specifications on page 32.

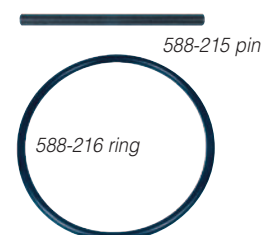

# Non-Metric Impact Sockets

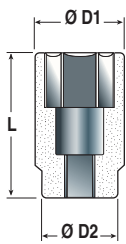

## 1" Square Drive Sockets

A/F	Part no.	L (mm)	Part no.	L (mm)	D1 (mm)	D2 (mm)
	Standard Sockets		Deep Sockets		Socket Ø	
7/8"	S68H78	58	S68H78L	90	39	54
15/16"	S68H1516	58	S68H1516L	90	41	54
1"	S68H1	60	S68H1L	90	43	54
1 1/16"	S68H1-116	60	S68H1-116L	90	45	54
1 1/8"	S68H1-18	62	S68H1-18L	90	46	54
1 1/4"	S68H1-14	63	S68H1-14L	90	54	54
1 5/16"	S68H1-516	63	S68H1-516L	90	54	54
1 7/16"	S68H1-716	66	S68H1-716L	90	57	54
1 1/2"	S68H1-12	66	S68H1-12L	90	59	54
1 9/16"	S68H1-916	66	S68H1-916L	90	61	54
1 5/8"	S68H1-58	68	S68H1-58L	90	63	54
1 11/16"	S68H1-1116	70	S68H1-1116L	90	65	54
1 3/4"	S68H1-34	70	S68H1-34L	100	68	60
1 13/16"	S68H1-1316	72	S68H1-1316L	100	69	60
1 7/8"	S68H1-78	72	S68H1-78L	100	70	60
1 15/16"	S68H1-1516	76	S68H1-1516L	100	73	60
2"	S68H2	76	S68H2L	100	74	60
2 1/8"	S68H2-18	80	S68H2-18L	108	79	60
2 3/16"	S68H2-316	84	S68H2-316L	108	80	60
2 1/4"	S68H2-14	84	S68H2-14L	108	83	60
2 3/8"	S68H2-38	88	S68H2-38L	108	87	60



## 1/2" Square Drive Sockets

A/F	Part no.	L (mm)	Part no.	L (mm)	D1 (mm)	D2 (mm)
	Standard Sockets		Deep Sockets		Socket Ø	
3/8"	S64H38	38	S64H38L	78	17	22
7/16"	S64H716	38	S64H716L	78	18	22
1/2"	S64H12	38	S64H12L	78	20	22
9/16"	S64H916	38	S64H916L	78	22	24
5/8"	S64H58	38	S64H58L	78	24	24
11/16"	S64H1116	38	S64H1116L	78	26	26
3/4"	S64H34	40	S64H34L	78	28	28
13/16"	S64H1316	40	S64H1316L	78	30	30
7/8"	S64H78	42	S64H78L	78	32	32
15/16"	S64H1516	44	S64H1516L	78	34	34
1"	S64H1	44	S64H1L	78	36	36
1 1/16"	S64H1-116	46	S64H1-116L	78	38	38
1 1/8"	S64H1-18	46	S64H1-18L	78	40	38

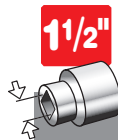

## 1 1/2" Square Drive Sockets

A/F	Part no.	L (mm)	Part no.	L (mm)	D1 (mm)	D2 (mm)
	Standard Sockets		Deep Sockets		Socket Ø	
1 5/8"	S612H1-58	80	S612H1-58L	115	70	86
1 11/16"	S612H1-1116	82	S612H1-1116L	115	73	86
1 3/4"	S612H1-34	84	S612H1-34L	115	75	86
1 13/16"	S612H1-1316	84	S612H1-1316L	115	76	86
1 7/8"	S612H1-78	87	S612H1-78L	115	78	86
1 15/16"	S612H1-1516	87	S612H1-1516L	115	80	86
2"	S612H2	87	S612H2L	135	82	86
2 1/16"	S612H2-116	87	S612H2-116L	140	83	86
2 1/8"	S612H2-18	90	S612H2-18L	140	86	86
2 1/4"	S612H2-14	95	S612H2-14L	150	90	86
2 3/8"	S612H2-38	95	S612H2-38L	150	94	86
2 1/2"	S612H2-12	100	S612H2-12L	150	98	86
2 5/8"	S612H2-58	105	S612H2-58L	150	102	86
2 3/4"	S612H2-34	105	S612H2-34L	160	106	86
3"	S612H3	108	S612H3L	170	113	86
3 1/8"	S612H3-18	115	S612H3-18L	170	118	86
3 1/2"	S612H3-12	123	S612H3-12L	170	129	86
3 3/4"	S612H3-34	123	S612H3-34L	180	137	95
4"	S612H4	130	S612H4L	190	147	95
4 1/4"	S612H4-14	135	S612H4-14L	190	154	95
4 1/2"	S612H4-12	140	S612H4-12L	210	164	95



## 3/4" Square Drive Sockets

A/F	Part no.	L (mm)	Part no.	L (mm)	D1 (mm)	D2 (mm)
	Standard Sockets		Deep Sockets		Socket Ø	
5/8"	S66H58	51	S66H58L	90	28	42
11/16"	S66H1116	51	S66H1116L	90	30	42
3/4"	S66H34	51	S66H34L	90	32	42
13/16"	S66H1316	51	S66H1316L	90	35	42
7/8"	S66H78	51	S66H78L	90	36	42
15/16"	S66H1516	51	S66H1516L	90	39	42
1"	S66H1	53	S66H1L	90	40	42
1 1/16"	S66H1-116	53	S66H1-116L	90	43	44
1 1/8"	S66H1-18	53	S66H1-18L	90	44	44
1 1/4"	S66H1-14	57	S66H1-14L	90	48	44
1 5/16"	S66H1-516	57	S66H1-516L	90	50	44
1 3/8"	S66H1-38	57	S66H1-38L	90	53	44
1 7/16"	S66H1-716	57	S66H1-716L	90	54	44
1 1/2"	S66H1-12	57	S66H1-12L	90	56	44
1 5/8"	S66H1-58	58	S66H1-58L	90	60	44

**Note:** There are more non-metric socket models available for the sizes 1", 1 1/2" and 2 1/2". Most of non-metric impact sockets are non-stocked items.

Impact Sockets

# Impact Sockets Accessories

## Retaining Rings

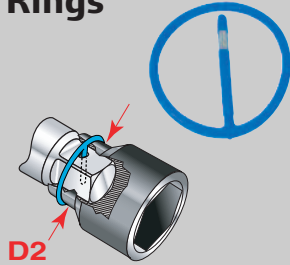

Part no.	Quantity	Int. Ø (mm)	Material
RR10001	10	15.0	Plastic
RR10002	10	17.0	Plastic
RR10003	10	19.0	Plastic
RR10004	10	20.0	Plastic
RR10005	10	22.0	Plastic
RR10006	10	24.0	Plastic
RR10007	10	24.0	Plastic
RR10008	10	29.0	Plastic
RR10005S	1	32.0	Plastic + Steel insert
RR10009	10	33.0	Plastic
RR10032S	1	36.5	Plastic + Steel insert

Part no.	Quantity	Int. Ø (mm)	Material
RR10010	10	37.0	Plastic
RR10034S	1	41.5	Plastic + Steel insert
RR10008S	1	44.5	Plastic + Steel insert
RR10010S	1	49.0	Plastic + Steel insert
RR10015S	1	54-57	Plastic + Steel insert
RR10017S	1	63.5	Plastic + Steel insert
RR10019S	1	67.0	Plastic + Steel insert
RR10020S	1	76.0	Plastic + Steel insert
RR10025S	1	86.0	Plastic + Steel insert
RR10030S	1	98.5	Plastic + Steel insert
RR10035S	1	111.0	Plastic + Steel insert

Because of the elasticity of the material, the diameter at the female square drive of the socket (D2) can be slightly larger than the ring. Note: The retainer rings must have a tight fit on the socket.



## Impact Socket Extensions

Part no.	Square drive	Length (mm)	Recommended retaining ring
E22H	1/4"	50	—
E24H	1/4"	100	—
E26H	1/4"	150	—
E33H	3/8"	75	RR10003
E36H	3/8"	150	RR10003
E312H	3/8"	300	RR10003
E43H	1/2"	75	RR10006
E45H	1/2"	125	RR10006
E47H	1/2"	175	RR10006
E410H	1/2"	250	RR10006
E424H	1/2"	600	RR10006
E63H	3/4"	75	RR10034S
E67H	3/4"	175	RR10034S
E610H	3/4"	250	RR10034S
E413H	3/4"	330	RR10034S
E83H	1"	75	RR10015S
E87H	1"	175	RR10015S
E810H	1"	250	RR10015S
E813H	1"	330	RR10015S
E125H	1 1/2"	125	RR10025S
E1210H	1 1/2"	250	RR10025S
E1220H	1 1/2"	500	RR10025S

## Universal Joints

Part no.	A (mm)	B (mm)	Recommended retaining ring
J2	1/4"	1/4"	—
J3	3/8"	3/8"	—
J4	1/2"	1/2"	—
J6	3/4"	3/4"	RR10034S
J8	1"	1"	RR10015S
J12	1 1/2"	1 1/2"	RR10025S
J20	2 1/2"	2 1/2"	RR10035S

## 90° Power Angle Attachments (1)



Angle head part no.	Square drive	Hammer housing part no.	Compatible tools
4UA9 (2)	1/2"	N/A	Any 1/2" Ingersoll Rand Impactool™
2920A90 (3)	3/4"	2920B-A827	2920 Series & 261
2934A90 (3)	1"	2934-A827	2934 Series, 280, 290

- (1) Reduction of output torque approx. 25%.
- (2) 4UA9 is held by the operator.
- (3) Hammer mechanism of the impactool™ has to be replaced.

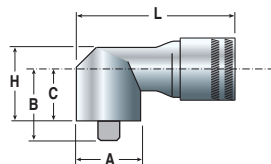

Angle head	Dimensions (mm)				
	A	B	C	L	H
4UA9	55	—	—	159	75
2920A90	67	78	46	175	84
2934A90	80	97	65	217	106

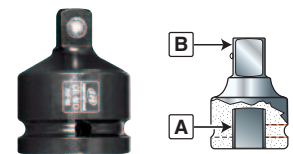

## Adapters

Part no.	A (mm)	B (mm)	Recommended retaining ring
A2F3M	1/4"	3/8"	—
A3F2M	3/8"	1/4"	RR10003
A3F4M	3/8"	1/2"	RR10003
A4F3M	1/2"	3/8"	RR10006
A4F6M	1/2"	3/4"	RR10008
A6F4M	3/4"	1/2"	RR10034S
A6F8M	3/4"	1"	RR10034S
A8F6M	1"	3/4"	RR10015S
A8F12M	1"	1 1/2"	RR10015S
A12F8M	1 1/2"	1"	RR10025S
A12F20M	1 1/2"	2 1/2"	RR10025S
A20F12M	2"	1 1/2"	RR10035S



Universal Joint

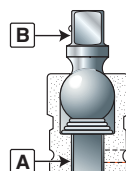



## Chisels, Jacksets, Steels

High quality chisels, retainers, steels and jacksets designed to enhance the performance of our tools. These lines are available in the most popular shank configurations and lengths.

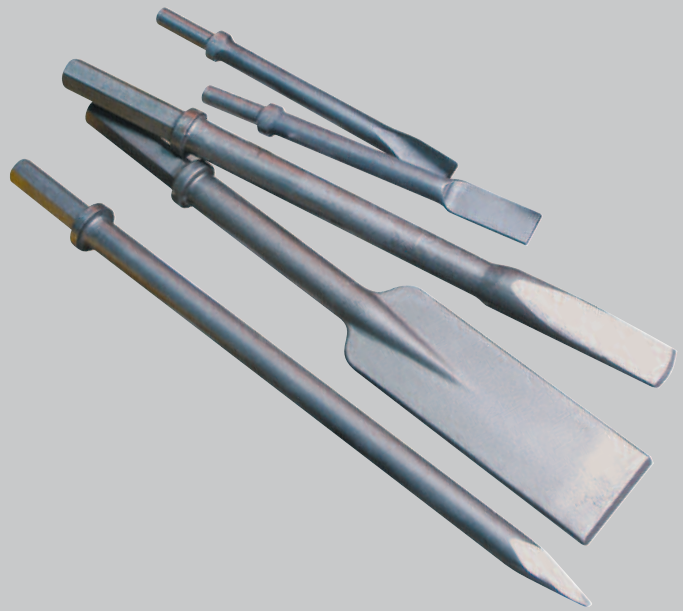
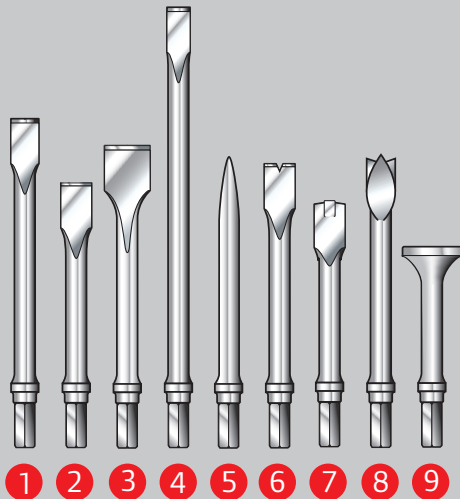

### Pneumatic Hammer Chisels

For 116-EU, 116H-EU, 121/Q-EU, 121/QH-EU, 118MAX, 122MAX and AVC Series hammers.

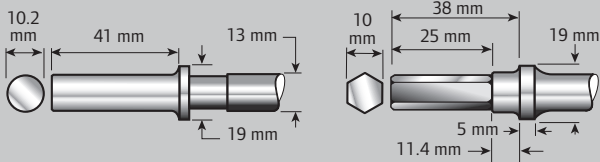

Type	Round shank / part no.	Hexagonal shank / part no.	 (mm)
<b>Standard</b>			
1	116-66	116-66H	19
5	116-70	116-70H	—
6	116-87	116-87H	19
7	116-88	116-88H	16
8	116-89	116-89H	19
<b>Industrial Grade</b>			
1	MC-66	MC-66H	19
2	MC-67	MC-67H	16
3	MC-68	MC-68H	35
4	MC-69	MC-69H	19
5	MC-70	MC-70H	—
6	MC121-87	MC121-87H	19
7	MC121-88	MC121-88H	16
8	MC121-89	MC121-89H	19
9	MC121-90	—	—

### Pneumatic Hammer Accessories

Part no.	Description
<b>Chisels</b>	
9500	Set of 5 chisels / 10.2 mm round shank
116H-K5	Set of 5 chisels / 10 mm hexagonal shank
<b>Chisel Retainers</b>	
9512	Quick change chuck for 116-EU, 116H-EU, 121/Q-EU, 121/QH-EU, 118MAX and 122MAX
115-183	Quick change spring retainer for 116-EU, 116H-EU, 118MAX and 122MAX
AVC10-183	Industrial grade quick change spring retainer for 121/Q-EU and 121/QH-EU
AVC1-83	Beehive (safety) spring retainer for AVC10, AVC12 and AVC13
AVC24-283	Beehive (safety) spring retainer for AVC26



9500



9512



115-183

Steels

# Pneumatic Tools Steels

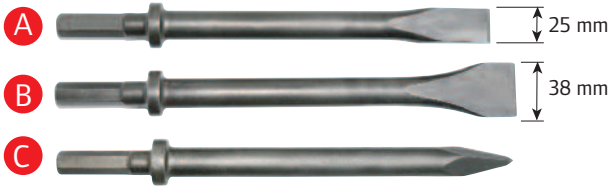

## Chipping Hammer Accessories

For Series K2LA1SA-EU and K2LA2SA-EU (oval collar).

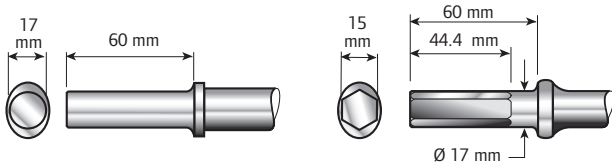

Type	Round shank / part no.	Hexagonal shank / part no.	Length (mm)	(kg)
<b>Extra Hard</b>				
A	HH1-215F-12	HH1-214F-12	305	0.8
A	HH1-215F-18	HH1-214F-18	455	1.1
A	HH1-215F-24	HH1-214F-24	610	1.3
A	HH1-215F-36	HH1-214F-36	915	2.4
B	HH1-215B-12	HH1-214B-12	305	0.8
C	HH1-215M-12	HH1-214M-12	305	0.8
C	HH1-215M-18	HH1-214M-18	455	1.1
C	HH1-215M-24	HH1-214M-24	610	1.3
C	—	HH1-214M-36	915	2.4

## Chipping Hammer Accessories

For Series W1A1-EU, W2A1-EU, W3A1-EU and W4A1-EU (round collar).

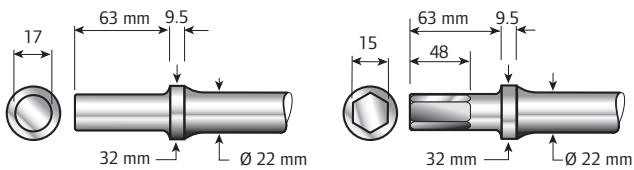

Type	Round shank / part no.	Hexagonal shank / part no.	Length (mm)	(kg)
<b>Extra Hard</b>				
A	H3R-215F-12	H3R-214F-12	305	0.8
A	H3R-215F-18	H3R-214F-18	455	1.1
A	H3R-215F-24	H3R-214F-24	610	1.3
A	H3R-215F-36	H3R-214F-36	915	2.4
B	H3R-215B-12	H3R-214B-12	305	0.8
C	H3R-215M-12	H3R-214M-12	305	0.8
C	H3R-215M-18	H3R-214M-18	455	1.1
C	H3R-215M-24	H3R-214M-24	610	1.3
C	—	H3R-214M-36	915	2.4

## Paving Breaker and Digger Accessories

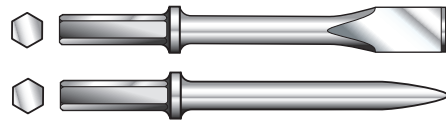

Part no.	Chisel type	Length (mm)	Cutting edge	(kg)
<b>7/8" x 3 1/4" (22 x 82) Hex Shank Size</b>				
50199207	Flat / narrow	350	25 mm	1.50
50199215	Flat / narrow	455	25 mm	1.80
50199223	Flat / narrow	610	25 mm	2.40
45510682	Flat / narrow	915	25 mm	3.40
50050269	Moil point	350	—	1.50
50050277	Moil point	455	—	1.80
50050285	Moil point	610	—	2.40
<b>1 1/8" x 6" (28 x 160) Hex Shank Size</b>				
50197904	Flat / narrow	350	25 mm	2.70
50197912	Flat / narrow	455	25 mm	3.30
50197938	Flat / narrow	610	25 mm	4.30
50050475	Moil point	350	—	2.70
50055524	Moil point	45	—	3.30
<b>1 1/4" x 6" (32 x 160) Hex Shank Size</b>				
50196385	Flat / narrow	350	25 mm	3.40
50196401	Flat / narrow	455	25 mm	4.10
50055680	Moil point	350	—	3.40
50055698	Moil point	455	—	4.10

## Demolition Tool Accessories

Jumbo shank for model 9001-EU

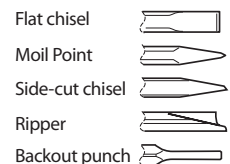
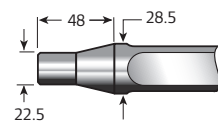

Part no.	Description	Length (mm)	(kg)
<b>Chisels</b>			
9001-276-12	Flat / narrow chisel	305	1.14
9001-276-18	Flat / narrow chisel	455	1.70
9001-297-12	Moil point chisel	305	1.14
9001-297-18	Moil point chisel	455	1.70
9001-277-9 1/2	Side-cut (steel rivet cutting)	241	0.90
9001-295-9 1/2	Ripper (splitting steel)	241	0.90
<b>Backout Punches</b>			
9001-278	For 3/8" rivet diameter	241	0.90
9001-279	For 1/2" rivet diameter	241	0.90
9001-280	For 5/8" rivet diameter	241	0.90
9001-281	For 3/4" rivet diameter	241	1.02
9001-282	For 7/8" rivet diameter	241	1.02
9001-283	For 1" rivet diameter	241	1.02

# Pneumatic Tools Steels

## Jacksets

10.2 mm shank diameter for riveters AVC10, AVC12 and AVC13

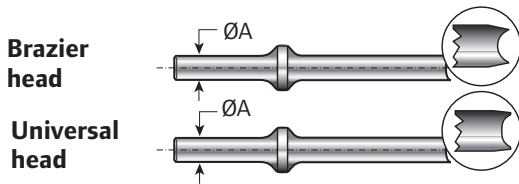

Ø A (mm)	Rivet head Ø (mm)	Brazier head / part no.	Universal head / part no.
10.2	2	—	AV1-22H-3
10.2	3	AV1-22C-4	—
10.2	4	AV1-22C-5	AV1-22H-5
10.2	5	AV1-22C-6	AV1-22H-6
10.2	6	AV1-22C-8	AV1-22H-8
10.2	8	AV1-22C-10	—

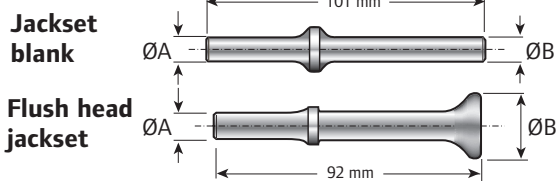

Ø A (mm)	Ø B (mm)	Soft blank / part no.	Flush head / part no.
10.2	13	AV1-22S-16	—
10.2	16	AV1-22S-20	—
10.2	19	AV1-22S-24	—
10.2	22	AV1-22S-28	—
10.2	25	—	AV1-126D

## Jacksets

12.7 mm shank diameter for riveters AVC26.

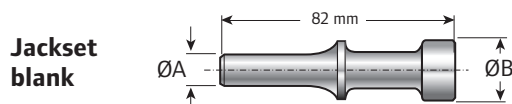

Ø A (mm)	Ø B (mm)	Part no.
12.7	21	AV24-222S-26
12.7	30	AV24-222S-38

## Scaler Accessories

Scaling chisels for Series 172 and 182

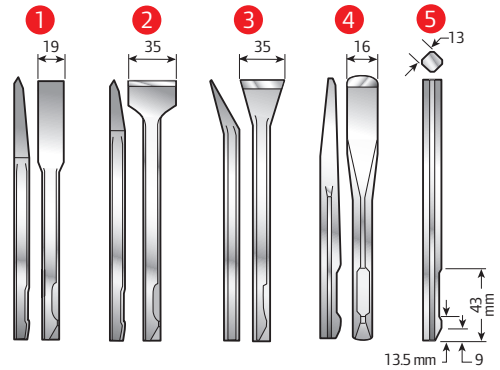

Type	Part no.	Length (mm)
<b>Extra Hard</b>		
1	WF-14F-7	178
1	WF-14F-12	305
2	WF-14B6 1/8	156
2	WF-14B-11 1/2	292
3	WF-14A-6 1/8	156
4	WF-14G-6	152
5	WF-14-7 1/8	181

Scaler attachment (housing) plus set of 19 steel needles – NS11 attachments allow conversion of models 172L, 182L and 182G-EU into needle scalers.



Part no.	Needle housing type	Needle length (mm)	Compatible Ingersoll Rand tool
NS11A	Round	127	172 & 182 Series
NS11A7	Round	178	172 & 182 Series
NS11B7	Rectangular	178	172 & 182 Series
PF2219-K19	Round	Without needle <sup>(1)</sup>	125-EU

(1) See 127 mm length needles hereunder.

Needles for 172, 182 and 125-EU scalers

Part no.	Material	Needle length (mm)
NS11-22-19	Steel	127
NS11-122-19	Steel	178
NS11-B22-19	Beryllium copper	127
NS11-S22-19	Stainless steel	127

# Surface Preparation Accessories

## Pads and Abrasives

Whatever your surface preparation needs happen to be, genuine Ingersoll Rand pads are specifically engineered to enhance the performance of our tools, ensuring you get the best finishing possible.

### Backing and Sanding Pads

Compatible tools	Part no.	Diameter (mm)	Type
<b>Non-Vacuum Pads</b>			
311A	<b>49097</b>	152	Vinyl, sanding pad
313A, 314A	<b>313-825-7</b>	178	Standard duty, rigid plastic
318A, 319A	<b>6130A</b>	178	Heavy duty, rubber
314A, 318A	<b>6135A</b>	200	50 mm thick polyester foam
317A	<b>317A-825</b>	76 & 127	Set of backing pads
77A	<b>77A-AM825-5</b>	127	Sanding pad
	<b>77A-AM825-7</b>	178	Sanding pad
	<b>77A-AM825-9</b>	225	Sanding pad
<b>Vacuum Pads (1)</b>			
4152-HL-SR	<b>010056</b>	76	Hook & loop sanding pad
R025, R035	<b>49693</b>	127	Hook & loop sanding pad
	<b>49096-1</b>	127	Vinyl sanding pad, grooved
4151-HL, 4152-HL R026, R036	<b>49835</b>	152	Hook & loop sanding pad
	<b>VPAD-6</b>	152	Vinyl sanding pad, grooved
<b>Rectangular Pads</b>			
312A	<b>312A-A825</b>	93 x 171	Sanding pad
315A	<b>315-39</b>	70 x 445	Sanding pad
<b>Polishing Bonnet</b>			
314A, 318A	<b>P500-850</b>	178	Wool polishing bonnet

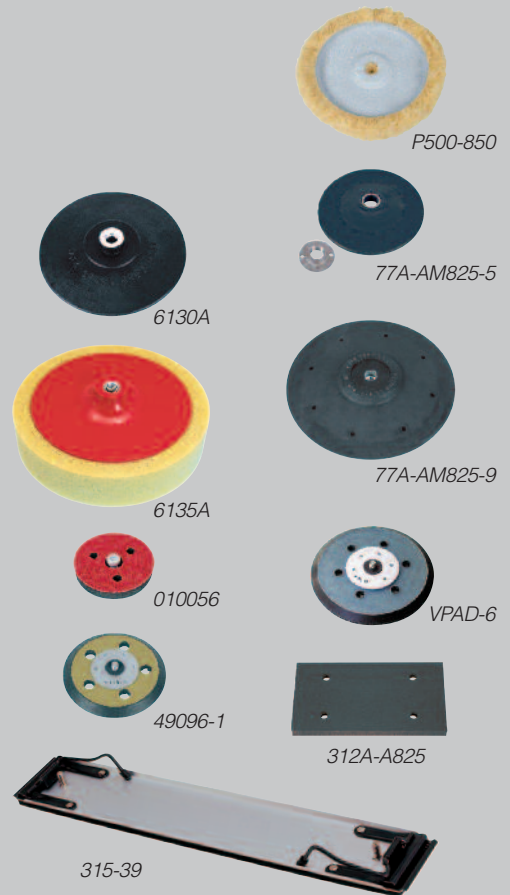

(1) Vacuum pads can also be used for non-vacuum applications.



### Sander Accessories

Description	4151-HL	4152-HL	R025	R035	R026	R036
Conversion kit (non-vacuum to vacuum)	<b>4151JV</b>		<b>RSVK-5</b>		<b>RSVK-6</b>	
Grip ring: small diameter (grey) (2)	—		<b>49801</b>	—	<b>49801</b>	—
Grip ring: medium diameter (black) (2)	<b>4151-747B</b>	<b>4151-2-747BLK</b>	<b>49798</b>	—	<b>49798</b>	—
Grip ring: large diameter (blue) (2)	—		<b>49799</b>	—	<b>49799</b>	—
Vacuum hose (1.8 m)	<b>49982</b>		<b>49982</b>		<b>49982</b>	
Eductor assembly	<b>49976</b>		<b>49976</b>		<b>49976</b>	
Vacuum adapter kit, Ø25, Ø28 and Ø32	<b>4151-809KIT</b>		<b>4151-809KIT</b>		<b>4151-809KIT</b>	
Cloth bag cover	<b>04611232</b>		<b>04611232</b>		<b>04611232</b>	
Disposable dust collection bag, quantity 20	<b>49988</b>		<b>49988</b>		<b>49988</b>	
Disposable dust collection bag, quantity 250	<b>49987</b>		<b>49987</b>		<b>49987</b>	

(2) Kit of 3 rings (1 grey, 1 black and 1 blue), part no. 49840.

# Surface Preparation Accessories

## Grinder Extended Warranty Kits

Part no.	Description	Compatible tool
AG1-XWXP2	Purchase a warranty kit with G-Series grinder and receive a full two year extended warranty	G1 Series
AG2-XWXP2		G2 Series
AG3-XWXP2		G3 Series



## Router Attachment Assembly

Part no.	Description
TD-RK4	For G2H-, TD- & HD-Series grinders



## 50 and 75 mm Quick-Change Pad & Abrasives

Part no.	Description	Quantity
<b>50 mm (2") Diameter</b>		
02A-MEDPD	Quick change pad with ¼ mandrel	1
02A-CRSBR-25	Coarse coating removal – brown grain	25
02A-MEDBR-25	Medium coating removal – maroon grain	25
02A-CRSBB-25	Quick-strip discs – bright blue	25
02A-036AO-25	Aluminium oxide discs – 36 Grit	25
02A-080AO-25	Aluminium oxide discs – 80 Grit	25
<b>75 mm (3") Diameter</b>		
03A-MEDPD	Quick change pad with ¼ mandrel	1
03A-CRSBR-25	Coarse coating removal – brown grain	25
03A-MEDBR-25	Medium coating removal – maroon grain	25
03A-CRSBB-10	Quick-strip discs – bright blue	10
03A-036AO-25	Aluminium oxide discs – 36 Grit	25
03A-080AO-25	Aluminium oxide discs – 80 Grit	25

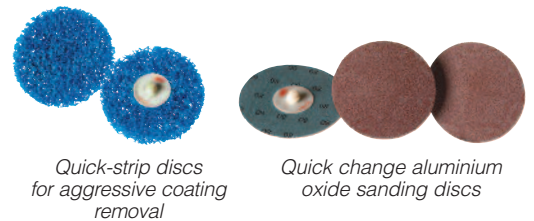

## 75 mm (3") Hook-and-Loop Pad, Discs & Bonnets

Part no.	Description	Quantity
<b>Backer Pad</b>		
03H-PAD-HL	75 mm Ø (3") - medium - hook & loop	1
<b>Sanding Discs</b>		
03H-040AO-50	Aluminium oxide – grit 40	50
03H-100AO-50	Aluminium oxide – grit 100	50
03H-180AO-50	Aluminium oxide – grit 180	50
03H-220AO-50	Aluminium oxide – grit 220	50
03H-320AO-50	Aluminium oxide – grit 320	50
03H-500AO-50	Aluminium oxide – grit 500	50
03H-800AO-50	Aluminium oxide – grit 800	50
<b>Polishing Bonnets</b>		
03F-SFTWL-6	Wool bonnet (for compounding)	6
03F-MEDFM-6	Waffle bonnet / white (for compounding)	6
03F-SFTFM-6	Waffle bonnet / yellow (for polishing)	6



## Sanding Belts

Part no.	Description	Quantity
LG1-SB812-60-10	12.7 x 305 mm (1/2 x 12") – Grit 60	10
LG1-SB812-80-10	12.7 x 305 mm (1/2 x 12") – Grit 80	10
LG1-SB812-100-10	12.7 x 305 mm (1/2 x 12") – Grit 100	10



# Product Specific Accessories

## Accessories for Drills, Grinders, Saws and more

### Steel Drill Chucks

Chuck part no.	Compatible tool	Chuck capacity (mm)	Key part no.
<b>3/8"-24 Female Thread</b>			
<b>R0H-99</b>	Industrial & production drills	0 - 6	<b>R1H-J253</b>
<b>6A-99</b>		0 - 10	<b>R0J-J253</b>
<b>R0K-99</b>		2 - 13	<b>R1T-J253</b>
<b>7804-255</b>	Service drills	1 - 6	—
<b>7802-99</b>		1 - 10	<b>R000B2J70-J253</b>
<b>7803-99</b>		1 - 13	<b>7803-253</b>
<b>For 1/4" Hexagonal Shaft</b>			
<b>123182</b>	Screwdriver with 1/4" hex	0 - 8	Included
<b>123205</b>		1 - 10	Included

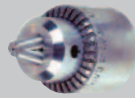

R0H-99



7804-255



123182



728-99-KC5

### Keyless Drill Chucks

Chuck part no.	Material	Chuck capacity (mm)
<b>3/8"-24 female thread</b>		
<b>728-99-KC5</b>	Composite	0 - 10
<b>728-99-KC8</b>		0 - 13
<b>KC10MM</b>	Steel	0 - 10
<b>KC13MM</b>		0 - 13

### Drill Collets



**1** For P33 drill / P45 head

Part no.	Collet Ø (mm)
120071	1.0
120072	1.5
120073	2.0
120102	2.2
120106	2.4
120074	2.5
120075	3.0
120105	3.1
120109	3.2
120104	3.25
120113	3.3
120076	3.5
123991	3.6
121552	3.7
125783	3.8
120107	3.9
120077	4.0
120103	4.1
120110	4.2
120078	4.5

**2** For P33 drill / P64 head

Part no.	Collet Ø (mm)
128250	1.6
128251	1.8
128252	2.0
128253	2.2
128254	2.4
128255	2.6
128256	2.8
128257	3.0
128258	3.2
128259	3.4
128260	3.6
128261	3.8
128262	4.0
128263	4.2
128264	4.4
128265	4.0
128266	4.8
128267	5.0
128268	5.2
128269	5.4
128270	5.6
128271	5.8
128272	6.0
128273	6.2
128274	6.4

**3** For P33 drill / P80 head

Part no.	Collet Ø (mm)
128280	2.4
128281	2.6
128283	3.0
128285	3.4
128286	3.6
128287	3.8
128288	4.0
128290	4.4
128291	4.6
128292	4.8
128293	5.0
128294	5.2
128296	5.6
128297	5.8
128298	6.0
128299	6.2
128300	6.4
128301	6.6
128302	6.8
128303	7.0
128304	7.2

**4** For P33 drill / F80 head

Part no.	Collet Ø (mm)
128310	2.0
128311	2.5
128312	3.0
128313	3.5
128314	4.0
128315	4.5
128316	5.0
128317	5.5
128318	6.0
128319	6.5
128320	7.0
128321	7.5
128322	8.0

**5** For QA, 1 and 5 Series

Part no.	Collet Ø (mm)
43497-40	2.4
43497-30	3.2
43497-27	3.6
43497-20	4.0
43497-11	4.8
43497-8	5.0

### Spindle Adapters

Fit directly on the spindle of any standard drill.



Part no.	Mounting thread / male	Spindle drive
<b>30629</b>	3/8"-24	1/2"-20 Male
<b>30384-5</b>	3/8"-24	3/8" Square
<b>30384-9</b>	3/8"-24	1/2" Square
<b>30712</b>	3/8"-24	1/4" Hex Quick Change

### Tapping Chucks

Can be used on 7667 Series straight power units or as replacement part on 7RAQT4-EU, QP15xxD8D tapper and 7429-D-EU self-reversing tapper.



Part no.	Mount	Collet insert (included)	Shank diameter (mm)
<b>R000AR2TM-199</b>	JT1	2U-103-1/4	3.5-6.5
<b>31427</b>	JT1	31437	3.5-6.5
<b>31432</b>	JT1	31436	4.5-8
<b>7RAQT4-99</b>	JT2	4U-103-1/2	7-12.7
<b>32060</b>	JT1(1)	32061	7-12.7

(1) 32060 chuck includes 32064 adapter from JT2 to JT1.

# Product Specific Accessories

## Grinder Collets

Chuck part no.	Compatible grinder	Collet capacity
DG110-700-G2	G1, CD, CA, CX Series 300 (Revolution) Series	1/8"
DG110-700-6MM		6 mm
DG110-700-G4		1/4"
G160HD-700-6MM	G2, G3, 61, T and H Series	6 mm
G160HD-700-1/4		1/4"
DG121HD-700-M8		8 mm
DG120HD-700-G6		3/8"
LA429-73		3 mm
301-700C	3100, 300A and LA400 Series	1/8"
301-700B		6 mm
301-700		1/4"



G160HD-700-1/4



DG120HD-700-G6



301-700B

## Cutting Blades for Saws and Windscreen Cutters

Part no.	Description	Compatible tool	Packing quantity
P4FS-6	Fine blade – 12 teeth/cm	429 and 4429	6
P4CS-6	Coarse blade – 10 teeth/cm	429 and 4429	6
LA418-CB1-90	Step blade	LA418-EU	1
LA418-CB2-36	Swept hook blade	LA418-EU	1
LA418-CB3-30	Curved blade	LA418-EU	1
LA418-CB4-8	Scraper blade	LA418-EU	1
LA418-CB6-35	Flat spade blade	LA418-EU	1
LA418-CB7-35	Angle straight blade	LA418-EU	1
LA418-CB8-24	Straight hook blade	LA418-EU	1
LA418-CB9-60	Circular blade	LA418-EU	1

Fine blade



Coarse blade



LA418-CB1-90



LA418-CB3-30



LA418-CB7-35



LA418-CB4-8



LA418-CB6-35



LA418-CB8-24



LA418-CB2-36



LA418-CB9-60

## Rammer / Tamper Butts

Part no.	Description	Compatible tool	Butt Ø (mm)	Rod thread
14SR-93R	Rubber-tipped peen	130A1M	60	1/2"
14SR-83R-2-3/8	Rubber-tipped butt	130A1M	60	1/2"
12SR-83	Steel butt	130A1M	64	1/2"
24SR-83R-3	Rubber-Tipped butt	241A1M	76	5/8"
24SR-93R	Rubber-tipped peen	241A1M	73	5/8"
22SR-83-3x3/4	Steel butt	241A1M	76	5/8"
34SR-M183-5-3/4	Malleable butt	341A2M	146	7/8"
44SR-M183-5-3/4	Malleable butt	441A2	146	1"

Steel butt



Rubber-tipped butt



Malleable butt



Rubber-tipped peen

## Tool Boots

Part no.	Compatible tool	Part no.	Compatible tool
103-BOOT	1105MAX, 105, R140, R145	2141-BOOT	2141, 2151
107-BOOT	107, 1077, R380, R385	261-BOOT	261, 271
109-BOOT	109XPA, 1099XPA	2161-BOOT	2161XP, 2171XP
2115-BOOT	2115, 2125	259-BOOT	259
2135-BOOT	2135	2190-BOOT	2190
2130-BOOT	2130XP	259-BOOT	259
231-BOOT	231GXP	7802-BOOT	7802A
		7803-BOOT	7803A



261-BOOT



2135-BOOT



2141-BOOT

# Torque Control Equipment

## EXTA & EXTT Expert Torque Analyser / Tester

Experienced tool users know that periodic calibration of precision Air and DC Electric tools is an essential part of any quality assurance system. Ingersoll Rand offers its user-friendly Expert Series of calibration equipment to meet this essential need.

### Common Platform for both EXTA and EXTT

- Four measurement modes to check effective torque values of angle wrenches & screwdrivers (peak and track modes), impulse tools and torque wrenches.
- Store up to 200 time-stamped readings.
- Monitor torque, angle, time, and count pulses (of impulse tools).
- Full statistical capabilities: Cp, Cpk, Pp, Ppk, CAM, CMK, range, mean, and standard deviation.
- Auto-recognition / auto-calibration of Smart transducers.
- Seven units of measure for compatibility with global standards.
- Rechargeable battery with selectable power-save settings.
- Selectable languages: English, French, German, Italian & Spanish.
- Additional battery backup for the internal memory.
- Auto power down timer keeps unit charged longer.
- Selectable filter frequencies.
- Delivered in a convenient carrying case EXTCASE with battery charger EXT-BC included.
- Quick download of results to printer or PC for data analysis, graphing, and documentation or calibration of DC electric tools using ICS software. Use cable ETA2-P925 for serial printer or ETA2-PC99 to connect to a computer.
- Quickstore (PC) software captures the EXTA & EXTT data for transfer, analysis and presentation. Quickstore is available as a free download at our website [www.ingersollrandproducts.com](http://www.ingersollrandproducts.com)
- Designed to comply with BS 7882 or DIN 51309 Class 1.0 requirements, to allow for optional calibration to be made according to BS7882 for entire measuring chain (torque analyser + transducer + connecting cable).



EXTA torque analyser for use with external transducers



EXTT torque tester (rundown adapter included)

### EXTA Torque Analyser:

Designed for portability and use with a broad range of external transducers: whether torque only or torque and angle. Use ETA2-TC cable for transducers supplied without cable.

Part no.(1)	External transducer	Data transfer	Auto recognition
EXTA	Smart or Industry standard	PC or printer	Yes

### EXTT Torque Testers:

Four models with integrated transducers that allow rapid and accurate torque checking of lower torque fastening tools from 0.4 to 30 Nm.

Part no.(2)	Torque range		Rundown adapter service kit
	(Nm)	(in-lb)	
EXTT-4	0.4 - 4	3.50 - 35	ETT-RA-4-KIT
EXTT-12	1.2 - 12	10.6 - 106	ETT-RA-12-KIT
EXTT-30	3.0 - 30	26.5 - 265	ETT-RA-30-KIT

### Typical Screen

- (1) EXTA torque analyser includes carrying case, battery charger, manuals, and neck strap.  
 (2) EXTT torque tester includes rundown adapter, carrying case, battery charger, manuals, and a certificate of calibration.



# Torque Control Equipment

## EXTT-30 shown with integrated transducer and rundown adapter.

Durable, compact and lightweight, ESD-safe. Power and hand tool compatibility: all you need to setup and calibrate all of your precision tools.

Large LCD screen (62 mm x 62 mm) for clear & easy reading of menus and test results.

Convenient mounting brackets (EXTT) to fix to the workbench or appropriate pins (EXTA) to attach neckstrap ETA2-STRAP (included with EXTA).



Rundown adapter: delivered with EXTT Series and fit EXTT Series only.

Soft-touch membrane keypad for simpler navigation and setup.

Indicator lights and audible alarm high/pass/low torque (>, =, <)

Dimensions 209 x 194 x 78 mm  
Weight 1.0 kg, EXTA - 2.1 kg EXTT



## Rotary Transducers

They are used mainly to control dynamic torque reached during fastening operations performed with mechanical or hand tools. With appropriate joint simulators recommended by Ingersoll Rand, they can also be used in laboratories and workshops.



TR and TRD rotary transducers



JKR joint simulator

### Joint simulators for rotary transducers

Part no. Industry standard	Part no. Smart transducers (1)		Torque range (Nm)	Drive size (in)
	Torque only	Torque & angle		
TR5H4	TRD5H4	TRDA5H4	0.25 - 5	1/4
TR20H4	TRD20H4	TRDA20H4	1 - 20	1/4
TR20S4	TRD20S4	TRDA20S4	1 - 20	1/4
TR75S6	TRD75S6	TRDA75S6	3.8 - 75	3/8
TR180S8	TRD180S8	TRDA180S8	9 - 180	1/2
TR250S12	—	—	12.5 - 250	3/4
TR500S12	TRD500S12	TRDA500S12	25 - 500	3/4

(1) TRD & TRDA are automatically recognized and calibrated for immediate use when attached to EXTA with fixed cable provided.

Part no.	Max. torque (Nm)	Output drive (in)	Input drive (mm)	Joint thread
JKR20	28	1/4	13	M8-1,25
JKR75	75	3/8	19	M12-1,75
JKR180	180	1/2	24	M16-2,0
JKR500	500	3/4	36	M24-3,0

## Stationary Transducers

They are used both in workshops as well as on assembly lines. They allow quick check of the torque set of a power or hand tool. For power tool verification they are usually used with an appropriate joint simulator. The simulator joint rate can be adjusted to emulate different joint conditions from hard to soft. Transducers with joint simulator kits are very useful in tool cribs to preset power tools for production and test power tool capability under different joint rates.

TS transducer



TS transducer with optional cable and JKS joint

TRANSDUCER Part no.	Torque range (Nm)	Drive size (in)	JOINT SIMULATOR Part no.	Max. torque (Nm)	Input drive (mm)	Joint thread (mm)	Replacement bolt kit for joint simulator
TS30S4 (2)	1,5-30	1/4	JKS30	20	13	M8-1,25	JKS30-BKIT
TS150S6 (2)	7,5-150	3/8	JKS150	75	19	M12-1,75	JKS150-BKIT
TS300S8 (2)	15-300	1/2	JKS300	180	24	M16-2,0	JKS300-BKIT
TS1000S12 (2)	50-1000	3/4	JKS1000	500	36	M24-3,0	JKS1000-BKIT

Transducers overload capacity up 110% of full capacity, accuracy: 0,3 % FSD, zero offset stability 0,1% / °C, operating temperature: 5 - 40°C.

(2) Also available as TSD "Smart" Series with fixed cable and automatic recognition and calibration by EXTA.

# Tool Lubricants

## Oils and Greases

By lubricating your air tools, you will prolong the life of tool motors, mechanisms, gearing, and other vital parts. Ingersoll Rand offers a complete line of specialised oils and greases that are engineered specifically for the use with air tools.



Part no.	No.	Description / Recommended use	Capacity
<b>Greases</b>			
23-1 LB	23	For the gearing of drills	0.45 kg
28 1 LB	28	For screwdriver gearing and clutches, drills, grinders, saws, tie tamper grease	0.45 kg
66 1 LB	66	For slow-speed, high-torque angle heads	0.45 kg
67-4T	67	For high-speed, high-temp angle heads (green)	0.12 l tube
67-1 LB			0.45 kg
68-1LB	68	For coupling splines and high speed angle heads	0.45 kg
70 1 LB	70	For large-piston motors and gear cases	0.45 kg
80 1 LB	80	For bearings on sump pumps	0.45 kg
80 8 LB			3.60 kg
100 1 LB	100	For standard-duty impact wrenches	0.45 kg
100 8 LB			3.60 kg
105-4T-6	105	For metallic housing impact wrenches	6 tubes of 0.12 l
105-1LB			0.45 kg
105-8LB			3.60 kg
115-4T	115	For composite housing impact wrenches	0.12 l
115-1LB			0.45 kg
150 8 LB	150	For impact mechanisms with swinging weight	3.60 kg
170-1 LB		Premium impact grease for high temperatures, used with impact mechanisms	0.45 kg
<b>Air Lubricating Oils</b>			
10Z4	10	For use with percussive, assembly, and impact wrenches	0.12 l tube
10P			0.50 l
10G			3.80 l
10GW			3.80 l
50P	50	For use with grinders, impact wrenches, hoists, and winches	0.50 l
50G			3.80 l
Lubri-Link Green	—	Unique U.S.D.A. accepted food grade chain lubricant	0.50 l

## Lubrication Kits and Accessories

Part no.	Description / Compatible tools
<b>Lubrication Kits</b>	
67-LBK1	80 g grease, 110 g oil and grease tube
105-LBK1	gun head
115-LBK1	gun head
<b>Grease Guns</b>	
P25-228	Push-type hand gun for hydraulic-type fittings
R000A2-228	Push-type hand gun for flush-type fittings
GTH-1	Grease gun used with Ingersoll Rand 0.12 l tube of grease
<b>Lubricants for VORTEX Turbine Grinder</b>	
VT22-SK1 <sup>(1)</sup>	lubricant kit (250 ml of oil + syringe)



(1) Note: VT22-T24 spindle lock key is required for oil change.

## UK & Ireland

Ingersoll Rand Industrial Technologies  
Sefton House, Northgate Close  
Middlebrook Business Park  
Bolton BL6 6PQ,  
United Kingdom  
Tel: +44 1204 479500  
Fax: +44 1204 479669  
E-mail: [ingersollranduk@irco.com](mailto:ingersollranduk@irco.com)  
E-mail: [ingersollrandireland@irco.com](mailto:ingersollrandireland@irco.com)

## France, BeLux & North West French Africa

Ingersoll Rand Industrial Technologies  
6 avenue Gutenberg  
77600 Bussy-Saint-Georges  
France  
Tel: +33 1 30 07 69 60  
Fax: +33 1 30 07 69 80  
E-mail: [ingersollrandfrance@irco.com](mailto:ingersollrandfrance@irco.com)  
E-mail: [ingersollrandbelgium@irco.com](mailto:ingersollrandbelgium@irco.com)

## Germany, Austria & Switzerland

Ingersoll Rand GmbH  
Industrial Technologies  
Max-Planck-Ring 27  
46049 Oberhausen  
Germany  
Tel: +49 208 9994 250  
Fax: +49 208 9994 252  
E-mail: [ingersollrandgermany@irco.com](mailto:ingersollrandgermany@irco.com)

## Netherlands

Ingersoll Rand Industrial Technologies  
Produktieweg 10  
2382 PB Zoeterwoude  
Netherlands  
Tel : +31 71 582 3456  
Fax : +31 71 582 3400  
E-mail: [info@ingersollrand.nl](mailto:info@ingersollrand.nl)

## Spain & Portugal

Ingersoll Rand Industrial Technologies  
C/ Casas de Miravete Nº 22B  
Edificio 1B - 3ª planta  
28031 Madrid  
Spain  
Tel: +34 91 627 7400  
Fax: +34 91 627 7401  
E-mail: [ingersollrandspain@irco.com](mailto:ingersollrandspain@irco.com)

## Italy, Greece, Turkey, Malta, Cyprus & Israel

Ingersoll Rand Industrial Technologies  
Strada Provinciale Cassanese 108  
20060 Vignate, Milano  
Italy  
Tel: +39 02 95 05 61  
Fax: +39 02 95 60 415  
E-mail: [ingersollranditaly@irco.com](mailto:ingersollranditaly@irco.com)

## Scandinavia

Ingersoll Rand Industrial Technologies  
Krossverksgatan 5 L  
21616 Malmö  
Sweden  
Tel: +46 40 16 20 60  
Fax: +46 40 16 20 65  
E-mail: [ingersollrandscan@irco.com](mailto:ingersollrandscan@irco.com)

## Poland, Estonia, Latvia & Lithuania

Ingersoll Rand Industrial Technologies  
Kolejowa 5/7  
01-217 Warszawa  
Poland  
Tel: +48 22 434 7770  
Fax: +48 22 434 7701  
E-mail: [ingersollrandeasterneurope@irco.com](mailto:ingersollrandeasterneurope@irco.com)

## Czech Republic, Slovakia & Hungary

Ingersoll Rand Industrial Technologies  
Florianova 2460  
253 01 Hostivice  
Czech Republic  
Tel: +420 257 109 756  
Fax: +420 257 109 758  
E-mail: [ingersollrandeasterneurope@irco.com](mailto:ingersollrandeasterneurope@irco.com)

## Russia & C.I.S.

Ingersoll Rand Industrial Technologies  
Omega Plaza, entrance 6  
19, Leninskaya Sloboda st.  
115280 Moscow  
Russia  
Tel: +7 495 933 03 21/22  
Fax: +7 495 785 21 26  
E-mail: [ingersollrandcis@irco.com](mailto:ingersollrandcis@irco.com)

## Bulgaria, Romania, Slovenia, Croatia, Bosna-H., Serbia & Montenegro

Ingersoll Rand Industrial Technologies  
Florianova 2460  
253 01 Hostivice  
Czech Republic  
Tel: +420 257 109 756  
Fax: +420 257 109 758  
E-mail: [ingersollrandeasterneurope@irco.com](mailto:ingersollrandeasterneurope@irco.com)

## Subsaharian Africa

Ingersoll Rand Industrial Technologies  
Michelle Ferrero Business Park  
21 Innes Road – Jet Park  
PO Box 14687, Witfield 1467  
South Africa  
Tel: +27 11 565 8600  
Fax: +27 11 565 8660  
E-mail: [ingersollrandsa@irco.com](mailto:ingersollrandsa@irco.com)

## Middle East & Africa

Ingersoll Rand Industrial Technologies  
7th Floor, Al Ghazal Complex  
Al Diyafah Street  
Dubai – P.O.Box 31000  
United Arab Emirates  
Tel: +971 4 346 0090  
Fax: +971 4 346 0087  
E-mail: [ingersollrandmea@irco.com](mailto:ingersollrandmea@irco.com)



Ingersoll Rand Industrial Technologies provides products, services and solutions that enhance our customers' energy efficiency, productivity and operations. Our diverse and innovative products range from complete compressed air systems, tools and pumps to material and fluid handling systems. We also enhance productivity through solutions created by Club Car®, the global leader in golf and utility vehicles for businesses and individuals.

[www.ingersollrandproducts.com](http://www.ingersollrandproducts.com)



Nothing contained within this brochure is intended to extend any warranty or representation, expressed or implied, regarding the products described herein. Any such warranties or other items or conditions of sale of products shall be in accordance with Ingersoll Rand's standard terms and conditions of sale for such products, which are available upon request. Product improvement is a continuing goal at Ingersoll Rand. Designs and specifications are subject to change without notice or obligation.